

Industry Training Register

Schema definition

Contents

Industry Training Register	1
Schema definition	1
Contents	3
1 Introduction	7
1.1 About this document	7
1.2 Status of this document	7
1.3 Changes since version 10.....	7
1.4 Other resources.....	8
1.5 Feedback and getting help.....	8
1.6 Terminology and conventions	8
1.7 Strings	9
1.8 Validation flow diagrams	9
2 About ITR	10
2.1 Overview	10
2.2 Terms and conditions	10
2.3 ITR event message structure.....	10
3 Basic message structure	12
3.1 Schema organisation	12
3.2 Base data types.....	13
3.3 Validation approach.....	15
4 Common message components	17
4.1 Overview	17
4.2 Learner details.....	17
4.2.1 Validation flow diagram.....	18
4.2.2 Learner identity	19
4.2.2.1 Validation flow diagram	21
4.2.3 Learner demographics.....	22
4.2.4 Education history	24
4.2.4.1 Validation flow diagram	27
4.3 Programme identifier	28
4.4 Qualification identifier	29
4.5 Standard identifier.....	30
4.5.1 Standard identifier with optional standard version number	30
4.5.2 Standard identifier with mandatory standard version number.....	31
4.6 Ceasing Programme Identifier Type.....	32
4.6.1 General validations	32
4.6.2 Sequence of messages	32
4.6.3 Business Rules	33
4.7 Enrolment Tracking Indicator Type	34
4.7.1 Valid ETI Codes.....	35
4.7.2 General validation	35
5 ITR messages	36
5.1 Overview	36
5.2 Create programme course	37
5.2.1 Active state in relation to programmes	38
5.2.2 TEC approvals process for NZA and MA funded programmes (versions).....	39
5.2.3 Common programme elements.....	41
5.2.3.1 Validation flow diagram	47

5.2.4	Limited credit programme (E1)	48
5.2.4.1	Validation flow diagram	50
5.2.5	Supplementary credit programme (SCP) (E2)	51
5.2.5.1	Validation flow diagram	53
5.2.6	National qualification (NQ) (E3)	54
5.2.6.1	Validation flow diagram	55
5.2.7	Complex modern apprenticeship and New Zealand apprenticeship (E4)	55
5.2.7.1	Validation flow diagram	58
5.3	Create new version of a programme course	59
5.3.1	Common programme elements	61
5.3.1.1	Additional validation rules	63
5.3.1.2	Validation flow diagram	64
5.3.2	Limited credit programme (E5)	65
5.3.2.1	Validation flow diagram	65
5.3.3	Supplementary credit programme (E6)	66
5.3.3.1	Additional validation rules	66
5.3.3.2	Validation flow diagram	67
5.3.4	National qualification (NQ) (E7)	68
5.3.4.1	Validation flow diagram	69
5.3.5	Complex modern apprenticeship (E8)	70
5.3.5.1	Additional validation rules	70
5.3.5.2	Validation flow diagram	71
5.4	Update programme (E9)	72
5.4.1	Additional validation rules	73
5.4.2	Validation flow diagram	75
5.5	Create training agreement	76
5.5.1	Validation flow diagram	80
5.5.2	Training agreement and enrolment statuses	81
5.5.3	Active state in relation to enrolments	86
5.5.4	Simple enrolment (E10)	87
5.5.5	Validation flow diagram	91
5.5.6	Business rules	99
5.5.7	Complex modern apprenticeship and New Zealand apprenticeship enrolment (E11)	100
5.5.8	Validation flow diagram	104
5.5.9	Business rules	112
5.6	Withdraw from training agreement (E12)	113
5.6.1	Validation flow diagram	115
5.6.2	Business rules	116
5.7	Update training agreement (E13)	117
5.7.1	Validation flow diagram	120
5.7.2	Business rules	121
5.8	Place training agreement on hold (E14)	122
5.8.1	Validation flow diagram	124
5.8.2	Business rules	124
5.9	Start training agreement grace period (E15)	125
5.9.1	Validation flow diagram	127
5.9.2	Business rules	127
5.10	Restart training agreement (E16)	128
5.10.1	Validation flow diagram	129
5.10.2	Business rules	129
5.11	Transfer employer (E17)	130
5.11.1	Validation flow diagram	134
5.11.2	Business Rules	135
5.12	Withdraw enrolment (E18)	136
5.12.1	Validation flow diagram	139
5.12.2	Business rules	140

5.13	Update simple enrolment (E19)	141
5.13.1	Validation flow diagram	144
5.13.2	Business rules	148
5.14	Update complex MA or NZA programme enrolment (E19)	148
5.14.1	Validation flow diagram	153
5.14.2	Business rules	159
5.15	Add enrolment (E20)	160
5.15.1	Validation flow diagram	163
5.15.2	Business rules	167
5.16	Create MA or NZA training plan (E22)	168
5.16.1	Validation flow diagram	171
5.16.2	Business rules	172
5.17	Transfer MAC (E23)	173
5.17.1	Validation flow diagram	175
5.17.2	Business rules	176
5.18	Record MAC visit (E24)	177
5.18.1	Validation flow diagram	178
5.18.2	Business rules	178
5.19	Delete MAC visit (E25)	179
5.19.1	Validation flow diagram	180
5.19.2	Business rules	180
5.20	Update MA or NZA training plan (E26)	181
5.20.1	Validation flow diagram	183
5.20.2	Business rules	184
5.21	Update learner details (E27)	185
5.21.1	Additional validation rules	186
5.22	Transfer Simple Programme Course Version (E28)	187
5.22.1	Simple enrolments allowed at Transfer	187
5.22.2	Unit standards allowed at Transfer	187
5.22.3	Validation Flow Diagram	191
5.22.4	Business rules	195
5.23	Transfer Complex Modern Apprenticeship Programme Course Version (E29)	196
5.23.1	Sub-programme enrolments allowed at Transfer	196
5.23.2	Unit standards allowed at Transfer	197
5.23.3	Validation flow diagram	202
5.23.4	Business rules	208
5.24	Delete Programme Enrolment (E30)	209
5.24.1	Validation flow diagram	211
5.24.2	Business rules	212
6	Fetch tertiary performance data	213
6.1	Fetch tertiary performance data request	214
6.1.1	Validation flow diagram	215
6.2	Fetch tertiary performance data response	216
6.2.1	Fetch training agreement details response	217
6.2.2	Fetch enrolment details response	219
6.2.2.1	Simple enrolment	219
6.2.2.2	Complex modern apprenticeship enrolment	221
7	ITR processing	225
7.1	Introduction	225
7.1.1	Order of processing	225
7.2	Complete enrolment via RoA	225
7.2.1	Detecting Enrolment Completions	225
7.2.2	Completing an Enrolment	226
7.2.3	Completing a Training Plan	226
7.3	Grace Period Expiry	227

7.3.1	Withdrawal reason for Grace Period Expiry	227
7.3.2	Processing.....	227
7.4	Tertiary Contact Management system (TCM)	228
7.5	Learner history.....	228
7.6	Learner event	228
7.7	Learner event history	228
7.8	Documentation	228
8	Appendices.....	229
8.1	Programme course naming convention.....	229
8.2	Validation business rules workflows.....	229
8.3	Success codes	231
8.4	Validation errors	231

1 Introduction

1.1 About this document

This document is for:

- SMS/TMS developers needing to prepare for implementation of the Industry Training Register computer system (ITR); and
- ITO and MAC operational personnel, to help them identify the data they need to collect and the business rules to apply to that data.

ITR's message architecture is one of two layers: an outer layer that manages the control of the message and an inner layer that contains the content of the message. This document describes the inner layer, including:

- the events and data elements of interest to the TEC;
- their meaning, data types and basic validation rules;
- the validation rules that will be applied.

It does not cover the following:

- the operational policy that defines the validation rules;
- business impacts of the ITR (which is covered found in the "ITR business impacts guide");
- integration between ITR and the Trainee Management Systems (TMS) (this is covered in the "ITR guide to integration").

While the document has been written with a non-technical audience in mind, it does assume a basic understanding of XML schemas.

IMPORTANT NOTE: The ITR will not be used to enforce all the rules and conditions set out in the Industry Training Operational and Modern Apprenticeships policies. ITOs will be required to make an annual attestation independently from the ITR and it will be the responsibility of the ITOs to submit information (including through the ITR) in accordance with the TEC's terms and conditions and policies.

1.2 Status of this document

The document is evolving as the details of the project are decided. It will be revised regularly, so please check www.tec.govt.nz for the most up-to-date version.

1.3 Changes since version 10

Changes made to this document since version 10 are highlighted as follows:

- Alterations are highlighted in **blue**.
- Deletions are highlighted in **pink**.

1.4 Other resources

The following resources are also available:

Resource	Available from
Industry Training and Apprenticeships Act 1992	www.legislation.govt.nz
ITR User Guide	http://www.tec.govt.nz/funding/funding-and-performance/reporting/itr/
ITR Guide to Integration	http://www.tec.govt.nz/funding/funding-and-performance/reporting/itr/
National Student Index (via MoE website)	http://www.education.govt.nz/further-education/tertiary-administration/national-student-index-nsi/
Statistical standards	Standards and classifications Stats NZ
TEC information feeds	http://www.tec.govt.nz/subscriptions
TEC website	www.tec.govt.nz
TEC Industry Training Fund information and conditions	http://www.tec.govt.nz/funding/funding-and-performance/funding/fund-finder/industry-training-fund/

1.5 Feedback and getting help

All questions and comments can be sent to the TEC Sector Helpdesk

CustomerService@tec.govt.nz. Information is also available in the ITO section of www.tec.govt.nz.

1.6 Terminology and conventions

As this document describes data to be supplied in an XML format, the terminology used is consistent with the XML standard. Some basic terminology and conventions used in this document are:

- **Element** – an item of data to be supplied is known as an “element” e.g. Surname and FirstName are examples of elements;
- **Cardinality** – Describes how many instances of an element must be supplied:
 - 0 – Optional, can only supply 1;
 - 1 – Mandatory, must supply a single value;
 - 0..x – Optional may supply many instances¹, where “x” is the maximum number of instances;
 - 1..x – Mandatory, must supply at least one value but could supply multiple, where “x” is the maximum number of instances.
- **Data Types** – The document lists the type or format of data required for a given element (e.g. string, integer etc), and uses XML types to describe this. Where the element contains sub elements, the data type will then be listed as “complex”.

¹ The schema may specify a maximum number of instances that may be supplied.

1.7 Strings

The ITR is case sensitive when it processes strings, so all strings contained in the messages sent by the ITO need to take this into consideration. For example a Local ID with a value of "XYZ123" will not be considered the same as a Local ID with a value of "xyz123".

All strings submitted in the messages sent by the ITO should be trimmed of leading and trailing white spaces.

1.8 Validation flow diagrams

There are a number of diagrams throughout the document which show the error codes and validation flows for the message. Please refer to the message element table for a full description of the validation.

2 About ITR

2.1 Overview

The Industry Training Register (ITR) computer system is an online data collection service that captures information about activity in the industry training sector as it happens. It captures information about learners and the events that happen while they are engaged in tertiary education. Examples include enrolment, completion and achievement of unit standards or a qualification.

ITR provides services that Trainee Management Systems (TMS) can use to update the TEC about changes to data held on their TMS.

2.2 Terms and conditions

Some messages within ITR include an element called "TermsAndConditionsIndicator". ITOs are no longer required to declare their agreement to the TEC's terms and conditions on a transaction by transaction basis. ITOs will be required to complete an annual declaration that they and their staff are complying with relevant terms and conditions.

ITR will not validate this value if provided and will save the value to the database.

2.3 ITR event message structure

A chart illustrating the structure of the ITR event messages follows on the next page.

ITR Event Message Structure

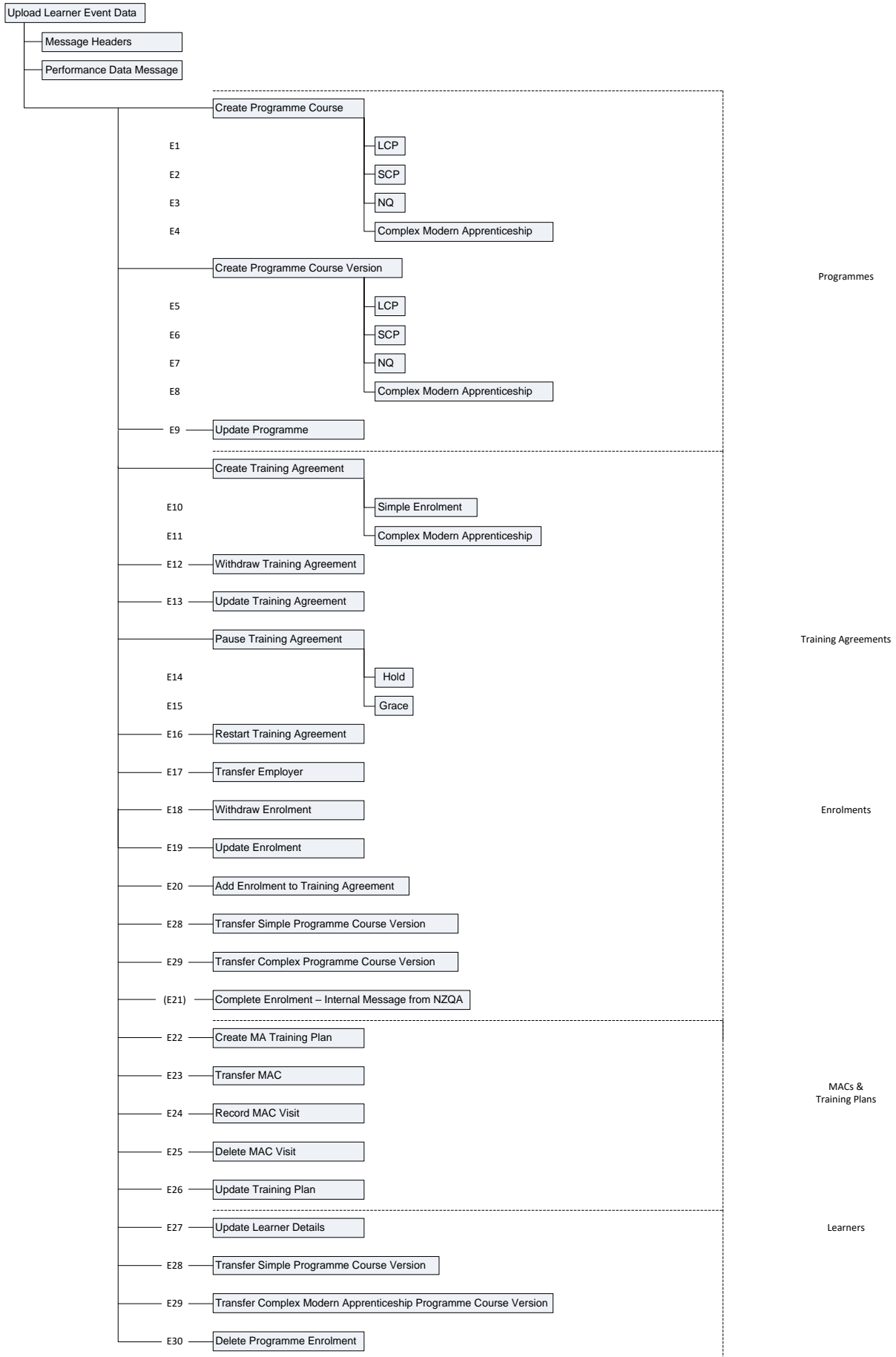

3 Basic message structure

3.1 Schema organisation

ITR messages are defined using an XML schema which specifies the elements required and structural rules such as cardinality, data types etc. The XML schema is a technical representation of the structures described in this document.

TMS vendors will need to validate ITR messages against the following schema:

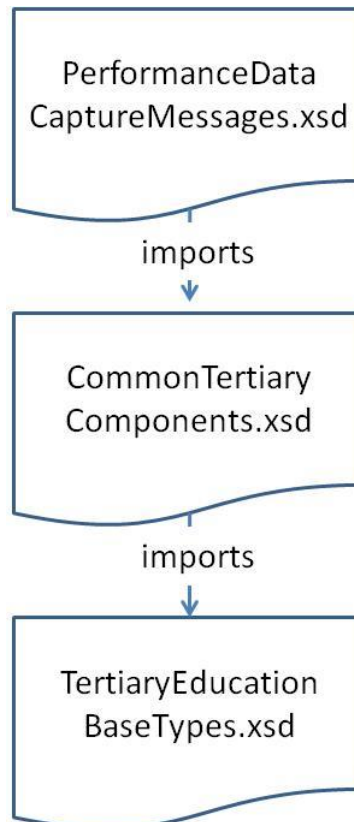

The purpose of each schema is as follows:

1. **PerformanceDataCaptureMessages.xsd** – Provides all of the complex types used for the purposes of capturing industry training related data e.g. learner details, training agreements, industry training programmes etc;
2. **CommonTertiaryComponents.xsd** – Provides definitions of complex types that may be used outside of ITR e.g. Programmeldentifier, QualificationIdentifier etc; and
3. **TertiaryEducationBaseTypes.xsd** – Many elements have common characteristics and meaning. This schema has common data types which are used by other schemas. Details of the base data types are described in section 3.2.

3.2 Base data types

The following base data types are used across all ITR XML messages.

Type name	Data type	Min length	Max length	Description
AmountType	xs:decimal	-	-	A number of monetary units specified in a currency where the unit of currency is explicit or implied.
CodeType	xs:string	1	20	A character string (letters, figures, symbols) that for brevity and / or language independency may be used to represent a definitive value of text of an attribute. Codes are usually maintained in code lists per attribute type.
CountType	xs:int	-	-	A numeric result stemming from counting distinct items.
DateType	xs:date	-	-	A date in the following format: CCYY-MM-DD. The date values are described as follows: CC: Century (19-20) YY: Year (01-99) MM: Month (01-12) DD: Day (01-31) Example: 12 March 1965 will be formatted "1965-03-12". The minimum value for a date is 1753-01-01. The maximum value for a date is 9999-12-31.
DescriptionType	xs:string	-	255	A character string generally in the form of words of a language describing a person, place, thing or concept.
EAddressType	xs:string	-	1024	A character string naming an electronic address such as e-mail address, url address.
IdentifierType	xs:string	1	20	A character string used to identify and distinguish uniquely, one instance of an object within an identification scheme from all other objects within the same schema.
IndicatorType	xs:boolean	-	-	Indicates whether a condition is true or false e.g. IsCurrentIndicator
MeasureType	xs:decimal	-	-	A numeric value determined by measuring an object. Measures are specified with an implicit or explicit unit of measure.

Type name	Data type	Min length	Max length	Description
NameType	xs:string	1	255	A word or phrase that constitutes the distinctive designation of a person, place, thing or concept.
NoteType	xs:string	-		A character string generally in the form of words of a language annotating a person, place, thing or concept.
NumberType	xs:string	1	20	A character string used to identify and distinguish uniquely, one instance of an object within an identification scheme from all other objects within the same scheme.
PercentageType	xs:decimal	-	-	A rate expressed in hundredths between two values that have the same unit of measure.
QuantityType	xs:decimal	-	-	A number of non-monetary units. It is associated with the indication of objects. Quantities need to be specified with a unit of quantity.
RankType	xs:decimal	-	-	A human-assigned, numeric value used to specify the sequence position of one instance of an object within a ranking scheme. The ranking scheme can be of any granularity, does not have to be unique nor continuous.
RateType	xs:decimal	-	-	A quantity or amount measured with respect to another measured quantity or amount, or a fixed or appropriate charge, cost or value e.g. NZ Dollars per hour, NZ Dollars per EURO, kilometre per litre, etc.
SequenceType	xs:int	-	-	
SystemIDType	xs:decimal	-	-	A numeric system-internal surrogate identifying key.
TextType	xs:string	-	255	A character string generally in the form of words of a language.
ValueType	xs:decimal	-	-	Numeric information that is assigned or is determined by calculation, (excluding counting, sequencing and ranking for which there are separate domains). It does not require a separate unit of quantity or a unit of measure.
YearType	xs:int	-	-	Calendar year.

3.3 Validation approach

All messages sent to the ITR will be validated to ensure supplied data complies with the structures and business rules included in this document. The ITR will return detailed error messages back to the Trainee Management System which is responsible for managing resolution of the errors. ITR will not update the ITR database if any errors are found; transactions containing errors must be fixed in the TMS and resubmitted.

There are 3 general types of errors considered by the ITR:

1. **Structure** - Messages sent must comply with the XML schemas identified in this document. No processing of the message will occur if the XML structure is not correct;
2. **Learner** - Where messages relate to a trainee, the ITR will attempt to validate the learner details against the National Student Index (NSI). If this check fails, further processing will stop and appropriate errors will be returned to the TMS; and
3. **Business transaction validations** – Having successfully identified the learner, ITR then validates the business transaction being submitted (e.g. create training agreement, complete Limited Credit Programme (LCP) etc). ITR will attempt to validate the transaction against all business rules listed in this document unless an error makes it impossible to continue. For example, validation could continue if the ITO entered an invalid industry code but could not if an incorrect programme number was entered as other validations depend on a valid programme number.

The diagram below describes the basic approach in more detail:

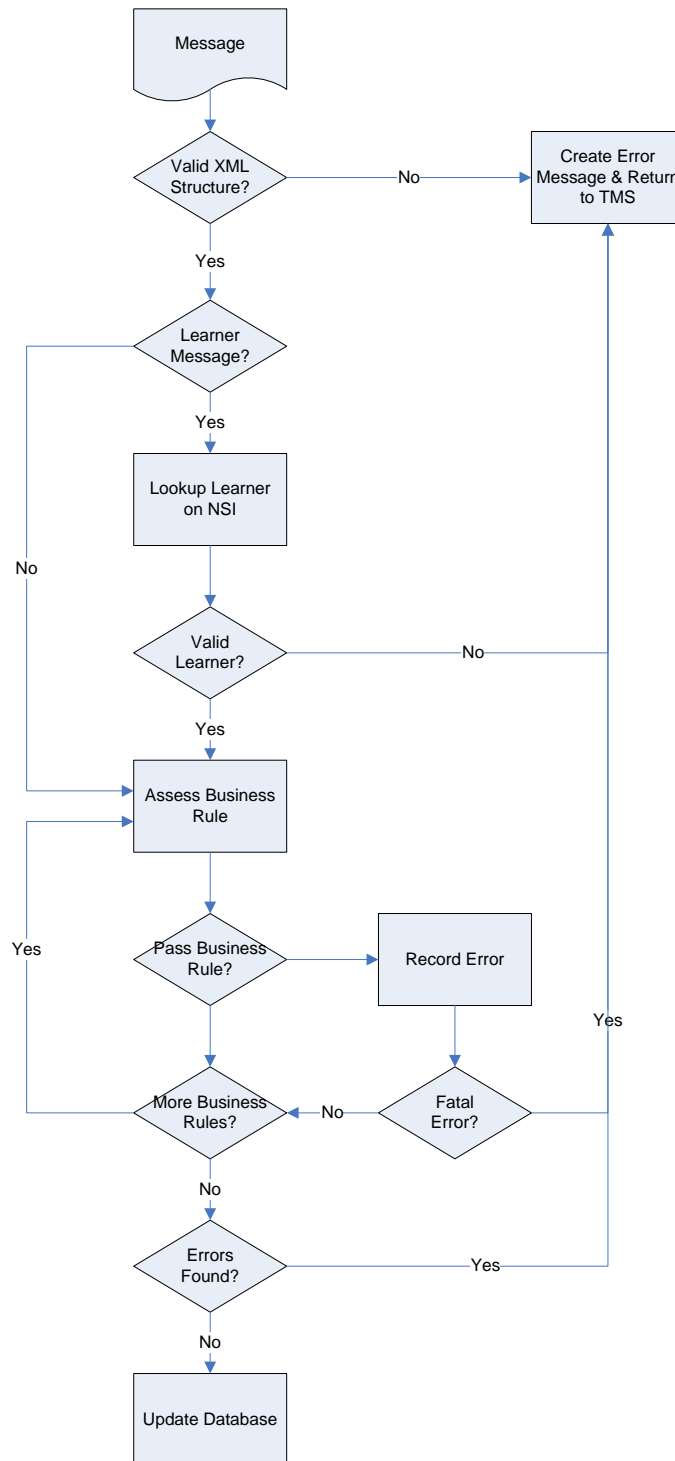

The reason for this approach is that TEC aims to validate as many business rules as possible and return all the errors at the same time so that they can be corrected all together, rather than being submitted, rejected, fixed and resubmitted many times.

4 Common message components

4.1 Overview

There are a number of data items that are contained in multiple different ITR transactions. The definitions for these items are described in this section rather than repeating them across the document.

4.2 Learner details

Almost all transactions sent to ITR supply a common set of attributes about a learner. These attributes are captured as part of each transaction to allow TEC to check that the transaction relates to a valid learner on the NSI, and to update other learner details if an update has not been supplied separately.

The diagram below identifies the 3 components of a learner. All 3 components must be sent with each learner based transaction e.g. enrolment, completion etc:

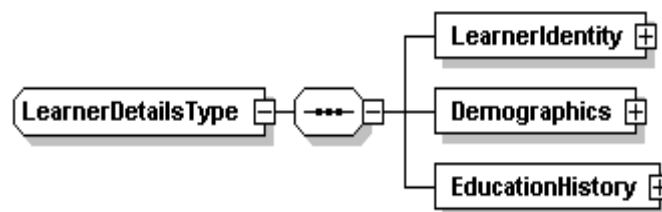

Generated with XMLSpy Schema Editor www.altova.com

Element name	Cardinality	Data type	Description
LearnerIdentity	1	Complex	Contains attributes used to uniquely identify a learner. These attributes will be used to verify the learners' identity against the NSI. See section 4.2.2 for details
Demographics	1	Complex	Characteristics of the learner such as ethnicity and iwi. This information will be used by the TEC for statistical reporting purposes. See section 4.2.3 for details
EducationHistory	1	Complex	Information about what education a learner had before entering tertiary education. See section 4.2.4 for details.

4.2.1 Validation flow diagram

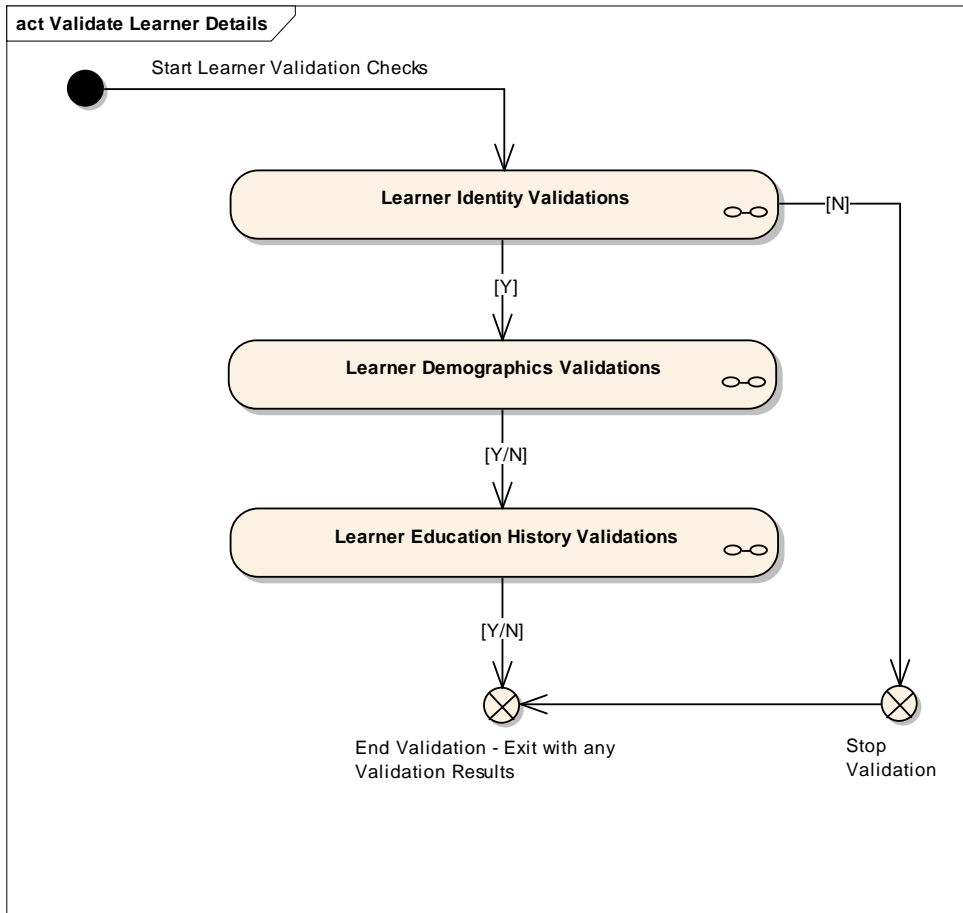

4.2.2 Learner identity

The purpose of LearnerIdentity is to capture information about the learner that helps TEC ensure transactions are recorded against the correct learner as held in the NSI.

The diagram below lists the elements that must be supplied for LearnerIdentity:

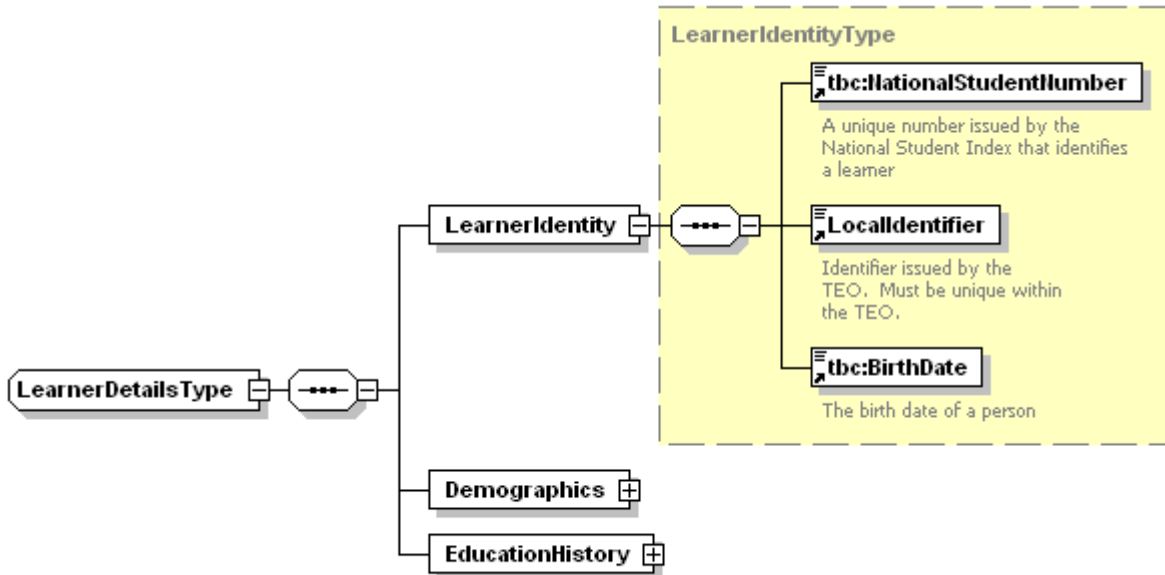

Generated with XMLSpy Schema Editor www.altova.com

Element name	Cardinality	Data type	Description
NationalStudent Number	1	Number Type	A unique number issued by the NSI that identifies a learner. ITOs will be required to submit the Master NSN for the learner, Validation: 1 ITR will check that the Master NSN exists on the NSI.
LocalIdentifier	1	Identifier Type	Typically this would be the number assigned to the student by the TMS. If the ITO uses the NSN as an identifier then the NSN should be supplied. The same LocalIdentifier must be used for the learner for ALL transactions associated with that learner in the future. Validation: 1 An ITO must not supply 2 or more different LocalIdentifiers for the same NSN. 2 LocalIdentifiers must be unique across different NSNs within the same organisation.
BirthDate	1	DateType	The Date of Birth of the learner. Validation:

Element name	Cardinality	Data type	Description
			1 Must exactly match the birth date held on the NSI.

4.2.2.1 Validation flow diagram

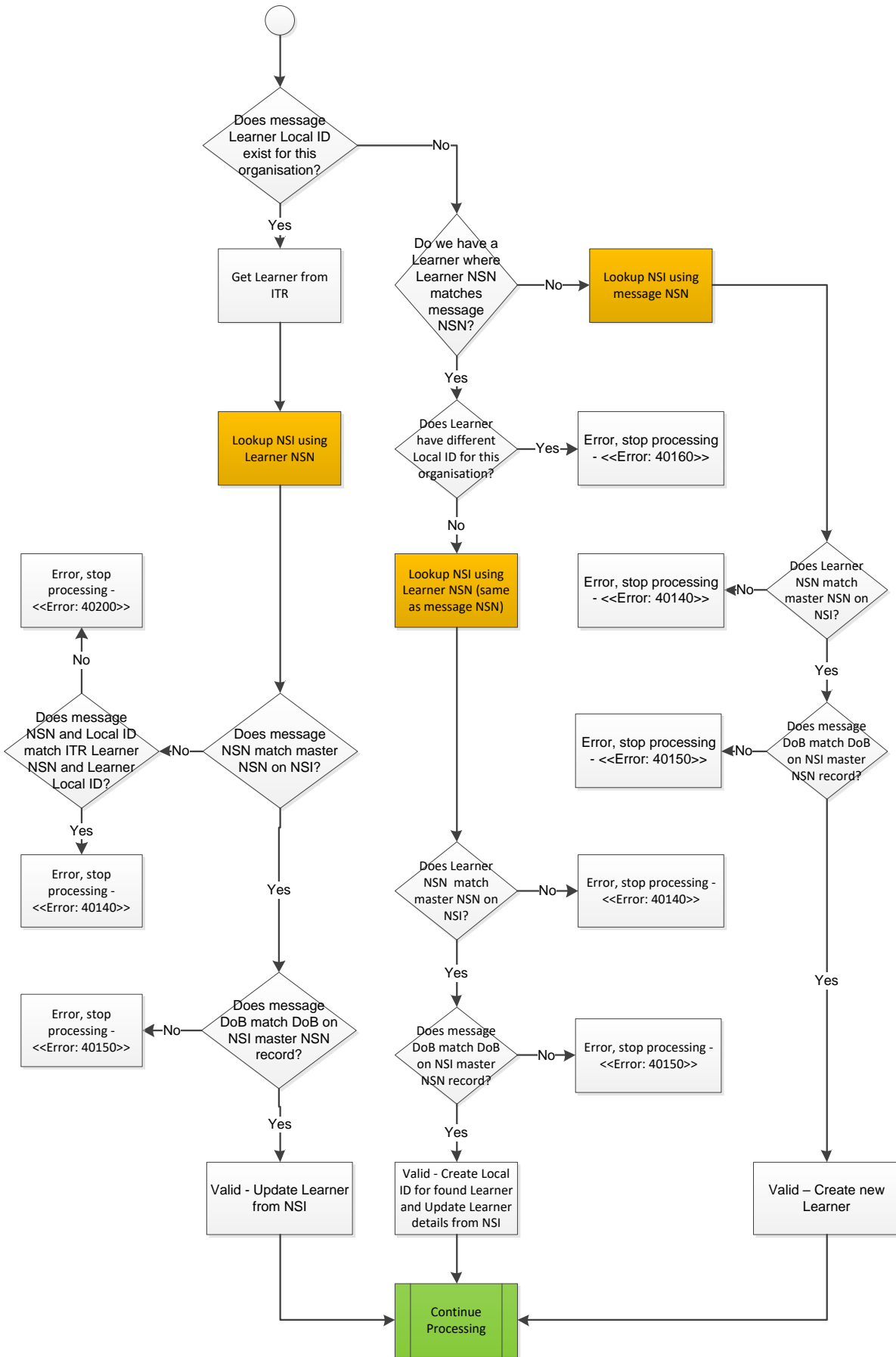

4.2.3 Learner demographics

The TEC uses demographic information such as the reported Ethnicity and Iwi at the time of enrolment for reporting and analytical purposes. The elements supplied are validated against the appropriate code value list but are not held on the NSI.

The diagram below lists the elements that must be supplied for Demographics:

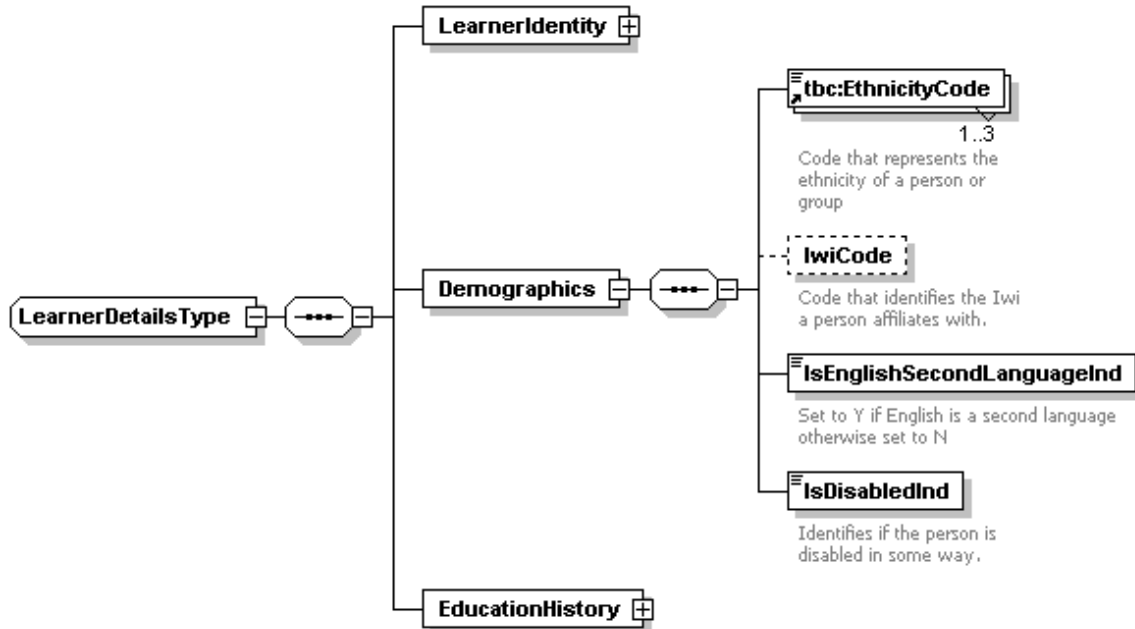

Generated with XMLSpy Schema Editor www.altova.com

Element Name	Cardinality	Data Type	Description
EthnicityCode	1..3	CodeType	<p>A code that represents the ethnicity of a person or group. Ethnicity codes are defined by Statistics New Zealand and are made up of 4 levels of classification.</p> <p>Validation:</p> <ol style="list-style-type: none"> Code must be one of the level 3 codes defined by Statistics New Zealand If more than one EthnicityCode has been provided, each one must be unique.
Iwi Code	0..1	CodeType	<p>A code that identifies the Iwi that a person affiliates with. Iwi codes are defined by Statistics New Zealand and are made up of 2 levels:</p> <p>Level 1 – Rohe (Iwi region)</p> <p>Level 2 - Iwi</p> <p>Validation:</p> <ol style="list-style-type: none"> Code must be one of the level 2 codes defined by Statistics New Zealand.

Element Name	Cardinality	Data Type	Description
IsEnglishSecondLanguageInd	1	Indicator Type	<p>A True/False flag that indicates whether English is a second language for the learner.</p> <ul style="list-style-type: none"> • False – if English is not a second language for the learner • True – if English is a second language for the learner
IsDisabledInd	1	Indicator Type	<p>This element assists in monitoring access and participation in tertiary programmes by people with disabilities. This field is an assessment by the trainee of whether they have a disability that has an impact on their ability to complete the programmes they are enrolling on.</p> <p>Please note that even if a trainee has a disability it may not have any impact on their ability to complete their programmes.</p> <p>Please see the Business Impacts document for a full description of how to use the disability flag.</p> <ul style="list-style-type: none"> • False – The trainee does not have a disability that will have an impact on their learning. • True – The trainee does have a disability that will have an impact on their learning <p>If the ITO cannot determine whether a trainee has a disability then they should return False for this element.</p>

Validation flow diagram

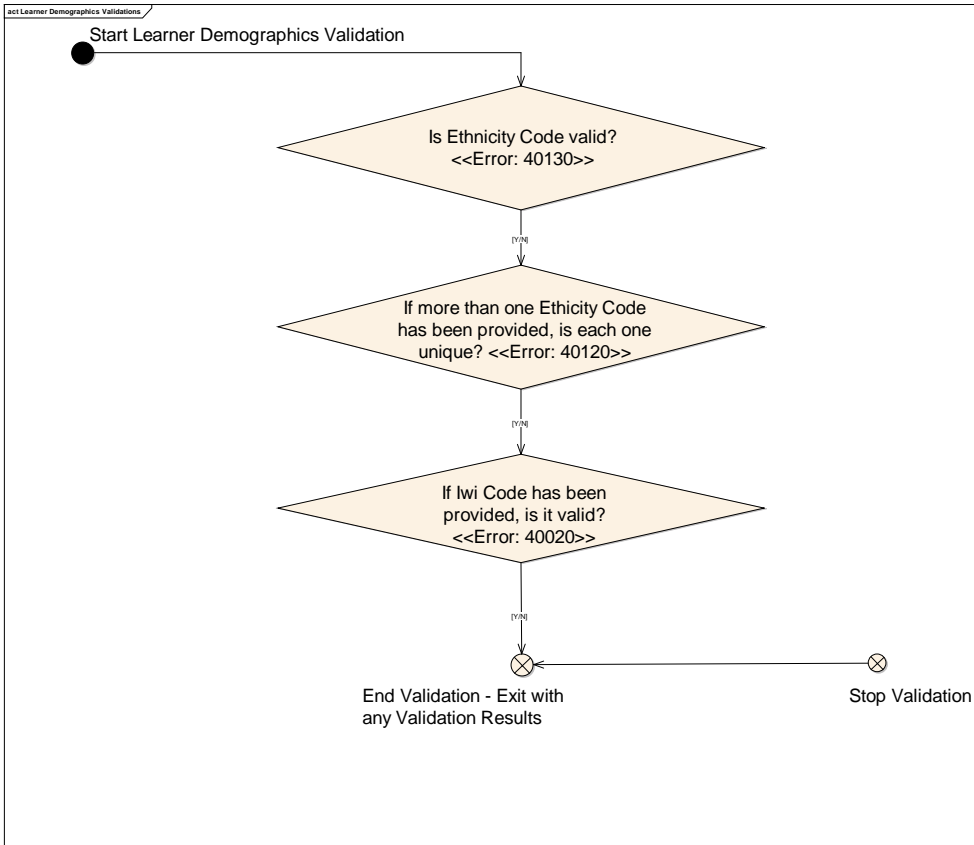

The purpose of the EducationHistory portion of LearnerDetails is to record what level of education a learner had when they enrolled on a programme or course. Please see the Business Impacts document for reasons for the collection of this information.

The diagram below lists the elements that must be supplied for EducationHistory:

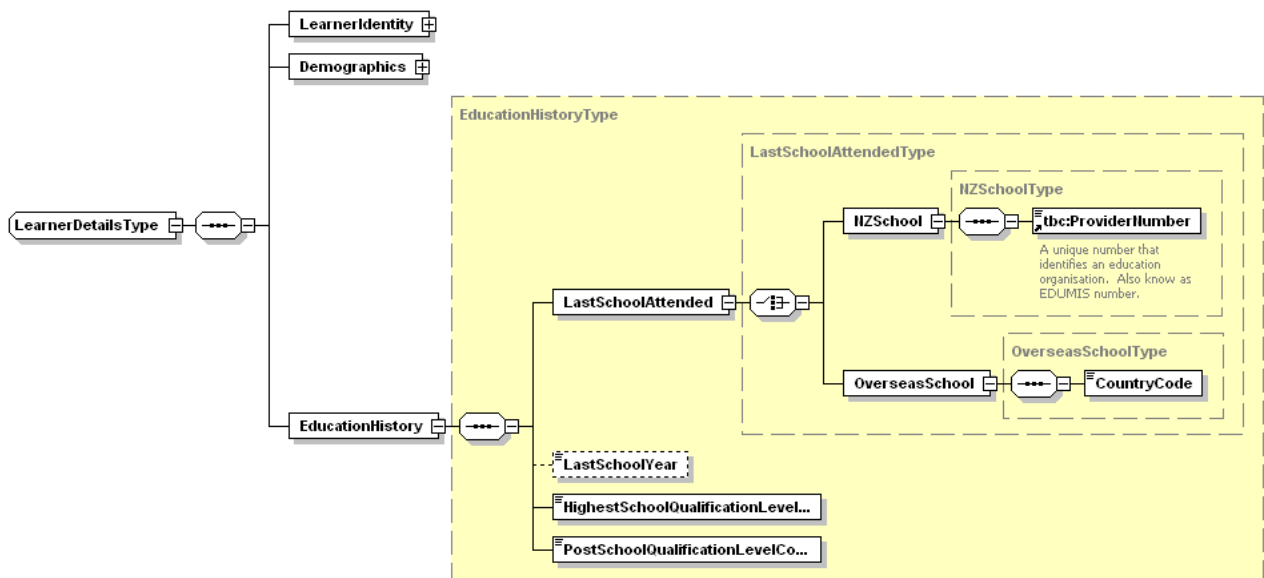

Generated with XMLSpy Schema Editor www.altova.com

Element Name	Cardinality	Data Type	Description						
LastSchoolAttended	1	Complex							
NZSchoolProvider Number	1	Number Type	A unique number that identifies an education organisation. Must be supplied if the learners' last school was in New Zealand. Validation: 1 Must match an existing or historical school as defined in appendix 2A and 2C of the SDR Manual ²						
OverseasSchool CountryCode	1	CodeType	A unique code defined by that identifies the country in which the learner last attended school. Must be supplied if the learners' last school was not in New Zealand. Validation: 1 Must be a 2 alpha country code and not "NZ".						
LastSchoolYear	0...1	YearType	The year a learner last attended school. Validation: 1 Must be one of the following values which match the SDR manual ³ . <table border="1"> <thead> <tr> <th>Value</th> <th>Description</th> </tr> </thead> <tbody> <tr> <td>yyyy</td> <td>A four digit year value, e.g. "1999"</td> </tr> <tr> <td>(blank)</td> <td>Not specified by student or not known</td> </tr> </tbody> </table>	Value	Description	yyyy	A four digit year value, e.g. "1999"	(blank)	Not specified by student or not known
Value	Description								
yyyy	A four digit year value, e.g. "1999"								
(blank)	Not specified by student or not known								
HighestSchool QualificationLevel Code	1	CodeType	A code that determines the highest level of schooling at which the learner has attained a qualification. Validation: 1 Must be one of the following values which match the SDR manual ⁴ : <table border="1"> <thead> <tr> <th>Value</th> <th>Description</th> </tr> </thead> <tbody> <tr> <td>00</td> <td>No formal secondary school qualification</td> </tr> <tr> <td>11</td> <td>14 or more credits at any level</td> </tr> </tbody> </table>	Value	Description	00	No formal secondary school qualification	11	14 or more credits at any level
Value	Description								
00	No formal secondary school qualification								
11	14 or more credits at any level								

² The codes defined in the SDR manual are being used to ensure consistency between the different data collection mechanisms across the tertiary sector.

³ The codes defined in the SDR manual are being used to ensure consistency between the different data collection mechanisms across the tertiary sector.

⁴ The codes defined in the SDR manual are being used to ensure consistency between the different data collection mechanisms across the tertiary sector.

Element Name	Cardinality	Data Type	Description																										
			<table border="1"> <tr> <td>12</td> <td>NCEA Level 1 or School Certificate</td> </tr> <tr> <td>13</td> <td>NCEA Level 2 or 6th Form Certificate</td> </tr> <tr> <td>14</td> <td>University Entrance</td> </tr> <tr> <td>15</td> <td>NCEA Level 3 or Bursary or Scholarship</td> </tr> <tr> <td>09</td> <td>Overseas qualification (includes International Baccalaureate & Cambridge Exams)</td> </tr> <tr> <td>98</td> <td>Other</td> </tr> <tr> <td>99</td> <td>Not known</td> </tr> </table>	12	NCEA Level 1 or School Certificate	13	NCEA Level 2 or 6 th Form Certificate	14	University Entrance	15	NCEA Level 3 or Bursary or Scholarship	09	Overseas qualification (includes International Baccalaureate & Cambridge Exams)	98	Other	99	Not known												
12	NCEA Level 1 or School Certificate																												
13	NCEA Level 2 or 6 th Form Certificate																												
14	University Entrance																												
15	NCEA Level 3 or Bursary or Scholarship																												
09	Overseas qualification (includes International Baccalaureate & Cambridge Exams)																												
98	Other																												
99	Not known																												
PostSchool QualificationLevel Code	1	CodeType	<p>A code that determines the highest level of qualification a learner has achieved after leaving school.</p> <p>Validation:</p> <p>1 Must be one of the following values which are based on the legacy system ILU and taken from Statistics New Zealand:</p> <table border="1"> <thead> <tr> <th>Value</th> <th>Description</th> </tr> </thead> <tbody> <tr> <td>00</td> <td>No Qualification</td> </tr> <tr> <td>01</td> <td>Level 1 Certificate</td> </tr> <tr> <td>02</td> <td>Level 2 Certificate</td> </tr> <tr> <td>03</td> <td>Level 3 Certificate</td> </tr> <tr> <td>04</td> <td>Level 4 Certificate</td> </tr> <tr> <td>05</td> <td>Level 5 Diploma/Certificate</td> </tr> <tr> <td>06</td> <td>Level 6 Graduate Certificate, Level 6 Diploma/Certificate</td> </tr> <tr> <td>07</td> <td>Bachelor Degree, Level 7 Graduate Diploma/Certificate, Level 7 Diploma/ Certificate</td> </tr> <tr> <td>08</td> <td>Postgraduate Diploma/Certificate, Bachelor Honours</td> </tr> <tr> <td>09</td> <td>Masters Degree</td> </tr> <tr> <td>10</td> <td>Doctorate Degree</td> </tr> <tr> <td>99</td> <td>Not Stated</td> </tr> </tbody> </table>	Value	Description	00	No Qualification	01	Level 1 Certificate	02	Level 2 Certificate	03	Level 3 Certificate	04	Level 4 Certificate	05	Level 5 Diploma/Certificate	06	Level 6 Graduate Certificate, Level 6 Diploma/Certificate	07	Bachelor Degree, Level 7 Graduate Diploma/Certificate, Level 7 Diploma/ Certificate	08	Postgraduate Diploma/Certificate, Bachelor Honours	09	Masters Degree	10	Doctorate Degree	99	Not Stated
Value	Description																												
00	No Qualification																												
01	Level 1 Certificate																												
02	Level 2 Certificate																												
03	Level 3 Certificate																												
04	Level 4 Certificate																												
05	Level 5 Diploma/Certificate																												
06	Level 6 Graduate Certificate, Level 6 Diploma/Certificate																												
07	Bachelor Degree, Level 7 Graduate Diploma/Certificate, Level 7 Diploma/ Certificate																												
08	Postgraduate Diploma/Certificate, Bachelor Honours																												
09	Masters Degree																												
10	Doctorate Degree																												
99	Not Stated																												

4.2.4.1 Validation flow diagram

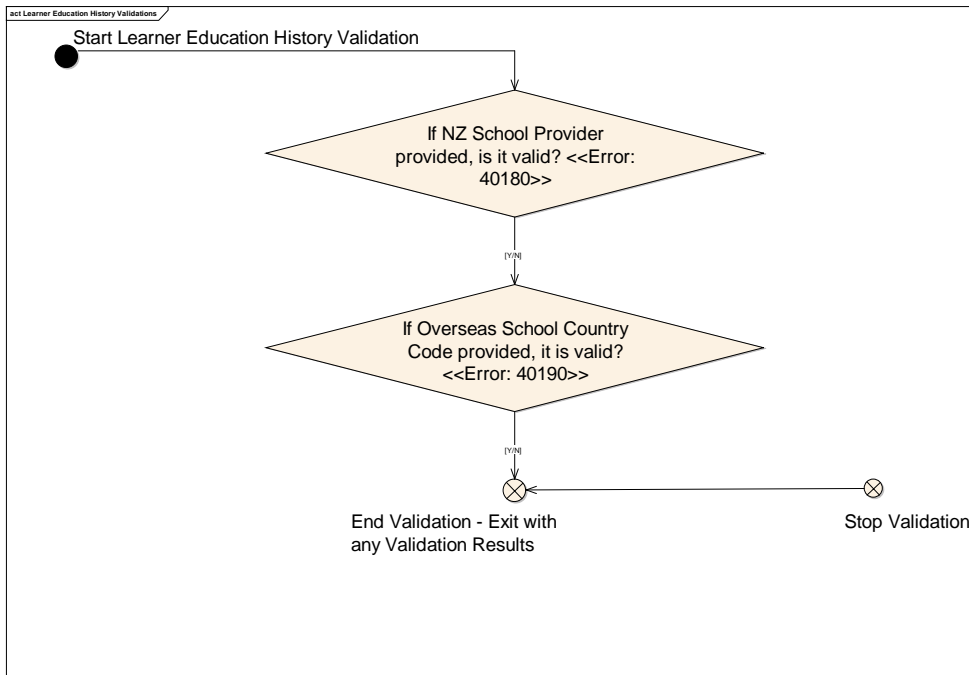

4.3 Programme identifier

A programme defines the training or education a trainee will undertake to achieve the goals of the programme. A programme identifier contains the elements required to uniquely identify a programme.

The diagram below shows the elements required to identify a programme:

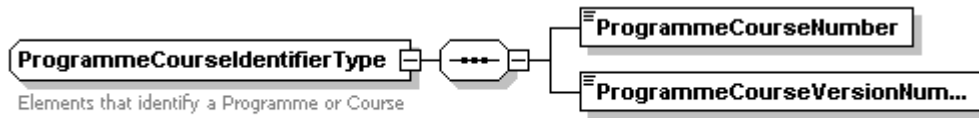

Generated with XMLSpy Schema Editor www.altova.com

The table below describes programme course identifier elements in more detail:

Element NAME	Cardinality	Data Type	Description
ProgrammeCourse Number	1	Number Type	A number that identifies a programme registered with the TEC.
ProgrammeCourse VersionNumber	1	xs:int	A number that identifies a version of a programme

4.4 Qualification identifier

A qualification defines "... requirements for certification established by a recognised standards-setting body or an education provider" [NZQA Glossary]. A qualifications identifier contains the elements required to uniquely identify a qualification.

The diagram below shows the elements required to identify a qualification:

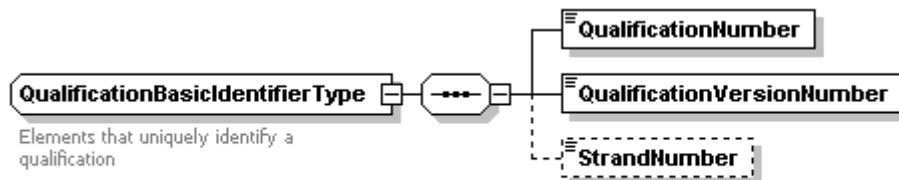

Generated with XMLSpy Schema Editor www.altova.com

The table below describes qualification identifier elements in more detail:

Element name	Cardinality	Data type	Description
QualificationNumber	1	Number Type	<p>A number that identifies a qualification registered on the National Qualifications Framework (NQF) (previously). New Zealand Qualification Framework (present)</p> <p>Validation:</p> <p>1 Must match a qualification on the NQF (NZQF) which is active (not expired).</p>
QualificationVersion Number	1	Number Type	<p>A number that identifies a version of a qualification on the NQF.</p> <p>Validation:</p> <p>1 Together with the QualificationNumber this must match a qualification on the NQF (NZQF) which is active (not expired).</p>
StrandNumber	0..1	Number Type	<p>A number that identifies a strand of a qualification. Only supply this value if you want to identify a specific strand of a qualification.</p> <p>Validation:</p> <p>1 If the StrandNumber is provided, null, whitespaces and "0" strand numbers will not be accepted. For any other values, ITR will check the strand and validate it exists on the NQF for this programme and version.</p>

4.5 Standard identifier

A standard is a specification of learning outcomes that are registered on the NQF. Standards form part of the definition of a programme and an enrolment in an industry training programme or modern apprenticeship. A standards identifier contains the elements required to uniquely identify a standard.

4.5.1 Standard identifier with optional standard version number

A standard version number can be optionally supplied at programme course registration.

The data structure below shows the elements used to identify a standard with optional standard version number:

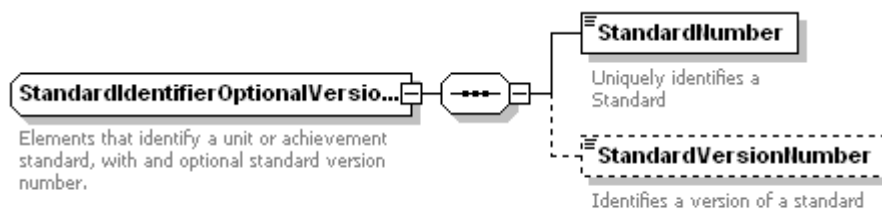

Generated with XMLSpy Schema Editor www.altova.com

The table below describes the elements of a standard identifier optional version in more detail:

Element Name	Cardinality	Data Type	Description
StandardNumber	1	Number Type	A number that identifies a standard on the NQF. Validation: 1 Must match a standard on the NQF.
StandardVersion Number	0..1	Number Type	A number that identifies a version of a standard on the NQF. Validation: 1 Together with the StandardNumber this must match a standard on the NQF.

4.5.2 Standard identifier with mandatory standard version number

A standard version number is required to be supplied at programme enrolment registration.

The data structure below shows the elements used to identify a standard with mandatory version number:

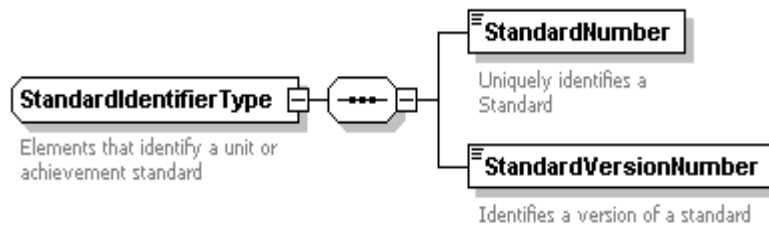

Generated with XMLSpy Schema Editor www.altova.com

The table below describes the elements of a standard identifier in more detail:

Element Name	Cardinality	Data Type	Description
StandardNumber	1	Number Type	A number that identifies a standard on the NQF. Validation: 1 Must match a standard on the NQF.
StandardVersion Number	1	Number Type	A number that identifies a version of a standard on the NQF. Validation: 1 Together with the StandardNumber this must match a standard on the NQF.

4.6 Ceasing Programme Identifier Type

This allows learners enrolled with one ITO to have their programme enrolment details linked to programme enrolment details in their previous ITO. This is primarily for calculating EPIs and STM offsets for merged ITOs or ITOs that have transferred coverage.

The EDUMIS and either the Programme Local Identifier or Enrolment Local Identifier (depending on which message this type is being used in) the trainee was previously enrolled in must be supplied in the messages of the Continuing ITO.

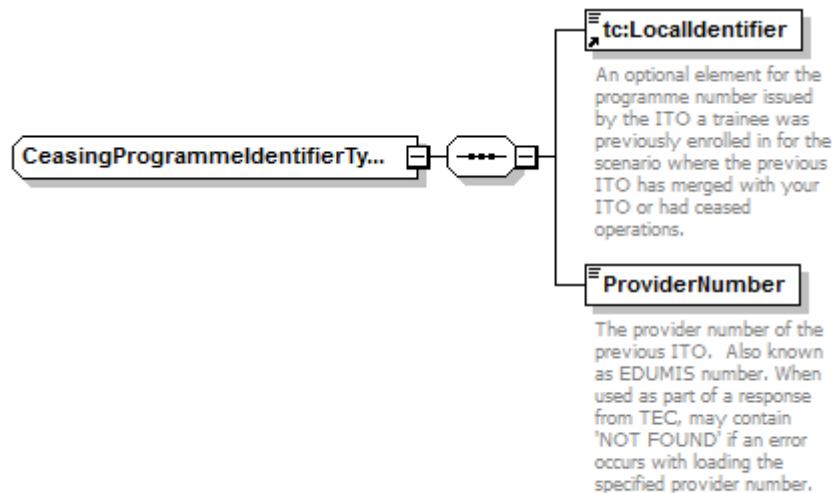

Generated by XMLSpy

www.altova.com

4.6.1 General validations

The ceasing Programme or Enrolment Local Identifier (depending on which message this type is used) must exist in the ITR for the EDUMIS number provided.

e.g. where `CeasingProgrammeIdentifierType` appears on `CreateProgrammeCourse` (or version) this refers to the Programme Course Local ID

The ceasing EDUMIS provided and the EDUMIS supplied (of the continuing ITO) as part of the message header (ref ITR Guide to Integration for ITO's section 5.3 – A823307) must have either a Merged or Transferred Coverage relationship in TEC's internal system, TCM.

The ceasing Enrolment Local Identifier is not supported for the `AddEnrolment (Simple)`, `TransferSimpleProgrammeCourseVersion` and `TransferComplexProgrammeCourseVersion` messages. If a ceasing Enrolment Local Identifier is included as part of any of these messages a validation failure of 42200 "A ceasing enrolment ID is not supported for this message" will be returned.

4.6.2 Sequence of messages

The messages and links must be created in the following order;

1. The relationship between the ITOs must be created in TEC's internal system, TCM (see business rules below).
2. Link the Continuing ITO's Programme to the Ceasing ITO's Programme.
3. Link the Continuing ITO's Enrolment ID to the Ceasing ITO's Enrolment ID.

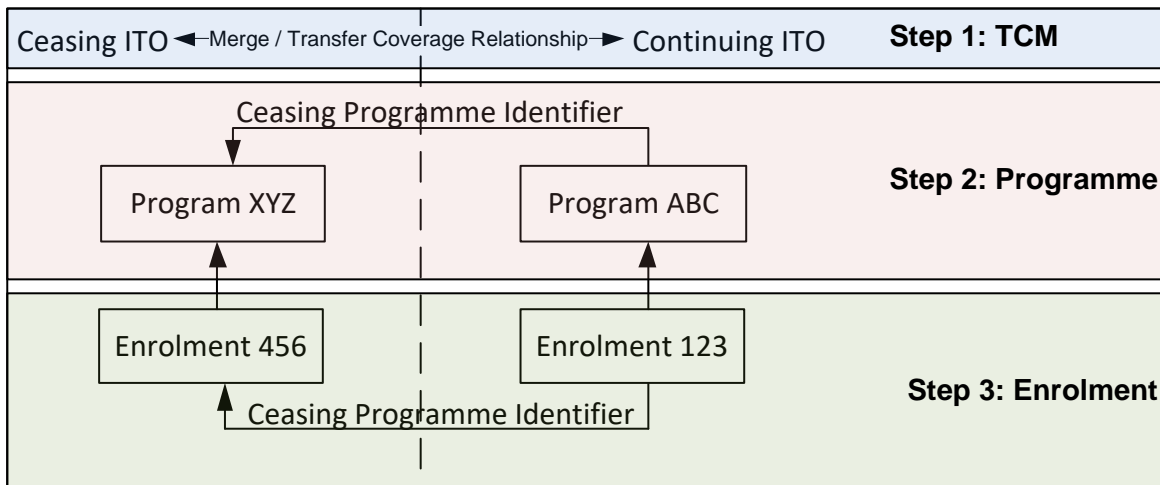

4.6.3 Business Rules

The business process for merging ITOs and ITOs that are transferring coverage must be under way between the TEC and the merging ITOs before any message with Ceasing Programme Identifier Type is submitted to the ITR. This is to ensure that the Merged or Transferred Coverage relationship is set up in TEC's internal system, TCM, as the ITR validates that this relationship exists. Otherwise the 55000 error 'The supplied EDUMIS for the programme version is not linked in TCM' will be returned.

Where a continuing enrolment is linked to a Withdrawn enrolment at the ceasing ITO, it must only be for learners that are continuing their learning at the continuing ITO.

In a complex arrangement, the enrolment should be linked at the parent enrolment level, and also at the sub-enrolment level where these have not been completed. Only the link at the parent enrolment level will be validated in the ITR.

In order to avoid enrolment validation failures due to concurrent enrolments, enrolments will be validated to ensure that the Participation Start Date of the continuing enrolment is at least two days after the Participation Start Date of the ceasing enrolment being linked to. As the ceasing enrolments will be automatically withdrawn one day before the Participation Start Date of the continuing enrolment by the ITR.

Where a link is made from a continuing enrolment to ANY part of a ceasing complex enrolment (either the overarching or the sub-enrolment or a combination of the two):

- i. The Participation Start Date of the continuing enrolment (where the link is supplied – including sub-enrolments) must be 2 or more days after the Participation Start Date of the Ceasing overarching enrolment.
- ii. For a Ceasing Complex Enrolment to be WITHDRAWN, the continuing enrolment must supply a link to the Ceasing Overarching Enrolment
 - a. The Ceasing Complex Enrolment will be WITHDRAWN (including all sub-enrolments) using a withdrawal date of 1 day before the Participation Start Date of the Continuing Enrolment which is linked to the Ceasing Overarching Enrolment
- iii. Linking from a Continuing Enrolment to just the Ceasing Sub-Enrolments and not the Ceasing Overarching Enrolment will not trigger the WITHDRAWAL outlined in ii)

4.7 Enrolment Tracking Indicator Type

The Tertiary Education Commission needs to track and report on the success of learners who are enrolled in an enrolment and have signed up for the Māori and Pacific Trades Training (MPTT) scheme. Additionally, similar reporting will be required for other schemes in the future.

The inclusion of an Enrolment Tracking Indicator (ETI) code on an enrolment indicates that the learner is completing this enrolment under a particular scheme e.g. Māori and Pacific Trades Training scheme.

Learners are able to sign up for multiple schemes at the same time; therefore the EnrolmentTrackingIndicator is able to accommodate multiple ETI codes at the same time.

A unique four character alphanumeric code is used for each scheme identifier e.g. MP01 for the Māori and Pacific Trades Training scheme

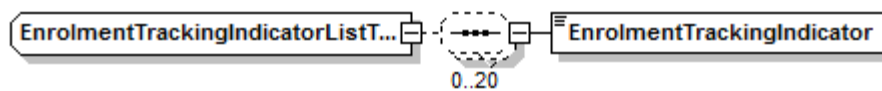

Generated with XMLSpy Schema Editor www.altova.com

The optional EnrolmentTrackingIndicator element of type CodeType has been added to the ProgrammeEnrolmentType. Specifically the element has been added to the following messages:

- a. CreateTrainingAgreement, specifically the following sub sections:
 - i. SimpleEnrolment
 - ii. CreateComplexModernApprenticeshipEnrolment
- b. UpdateSimpleEnrolment
- c. UpdateComplexModernApprenticeshipEnrolment
- d. TransferSimpleProgrammeCourseVersion
- e. TransferComplexProgrammeCourseVersion
- f. AddSimpleEnrolment
- g. FetchEnrolmentDetails

Setting the ETI codes will be done by submitting an enrolment message containing a valid EnrolmentTrackingIndicator code.

Submitting an enrolment message with an empty EnrolmentTrackingIndicator only will unset all the Enrolment Tracking Indicators on the Enrolment.

Submitting an enrolment message that does not including an EnrolmentTrackingIndicator will not affect the existing EnrolmentTrackingIndicator's on the enrolment.

Submitting an enrolment message with a subset of the EnrolmentTrackingIndicator will cause the ones which haven't been included to be unset.

For complex enrolments the EnrolmentTrackingIndicator will be set on the parent enrolment only.

The ETI codes will not be contained in the xml schema for the ITR, but will be validated by the ITR.

4.7.1 Valid ETI Codes

ETI Code	Detail	Effective From
MP01	Māori and Pacific Trades Training scheme	01/12/2013

4.7.2 General validation

If ETI codes are supplied they are validated against the valid codes as per 4.7.1. If one of the supplied ETI codes is not valid, the ITR will fail validation and return the error code 43500.

5 ITR messages

5.1 Overview

This section describes the structure of messages that a Trainee Management System will need to send to the ITR. Each of these messages represents an event that has occurred in the life of a learner within the tertiary education system e.g. enrolment, completion, transfer etc.

The ITR has been designed so a TMS can submit a message as soon as it is successfully validated and saved on the TMS. Submitting a message to ITR as soon as the event has been recorded on the TMS ensures the TMS and the ITR are as synchronised as possible. This also helps alert the ITO to data validation issues close to the point of data capture rather than months later as is the case with Industry Liaison Unit (ILU).

Each message is comprised of 2 parts:

1. Learner Details, supplied as part of each transaction to ensure the transaction is linked to the correct learner and to enable details to be updated; and
2. Message Specific Details, the specific details relating to the message being sent e.g. enrolment.

The following sections describe each message in detail.

5.2 Create programme course

Programmes and Courses are the definition of what education will be provided, coordinated or assessed by a tertiary education organisation. Programmes and Courses are based on clear and consistent aims, content, outcomes and assessment practices. A programme may consist of multiple other programmes or courses, but the most granular unit of education is called a “course”. While courses are out of scope for the ITR, they may be added at a later date.

Programmes and Courses are different from Qualifications which are a definition of something a learner may achieve, but not of how education is actually delivered or assessed.

An ITO can develop Programmes provided the qualification it leads to has been registered on the NQF and the ITO has the necessary accreditation and gazetted coverage.

ITR supports two different styles of Programme:

1. A basic industry training programme for either industry trainees or modern apprentices;
 - LCP – Limited Credit Programme (see section 5.3.4)
 - SCP – Supplementary Credit Programme (see section 5.3.3)
 - NQ - National Qualification (see section 5.3.4)
 - MC – Micro credential (see section 5.3.7)
 - A detailed modern apprenticeship programme that is a collection of industry training programmes a.k.a ‘Complex MA’ and “NZA”. (see section 5.3.3)

The process for registering a programme or course is as follows:

1. ITO requests registration of a programme or course;
2. ITR evaluates the request including checking that associated qualification(s) have been registered on the NQF;
3. ITR generates a TEC Programme Course Number and Programme Course Version Number.
4. This programme number and version number are then transmitted to the TMS for future reference.

The following sections describe the elements that must be supplied to register a new programme.

5.2.1 Active state in relation to programmes

At several points during the descriptions of programmes in this section, there will be reference to the state 'Active' e.g. an 'Active' target programme. Programmes themselves can be deemed active, and each programme can have multiple versions which may or may not be active. For comparisons, a programme is deemed as active when:

- The programme (and therefore its versions) belongs to the ITO.
- The programme and its version is not declined i.e. Approved
- The expiry date of the version has not passed
- The version has some time period overlapping the programme version you are comparing to (see diagram below):

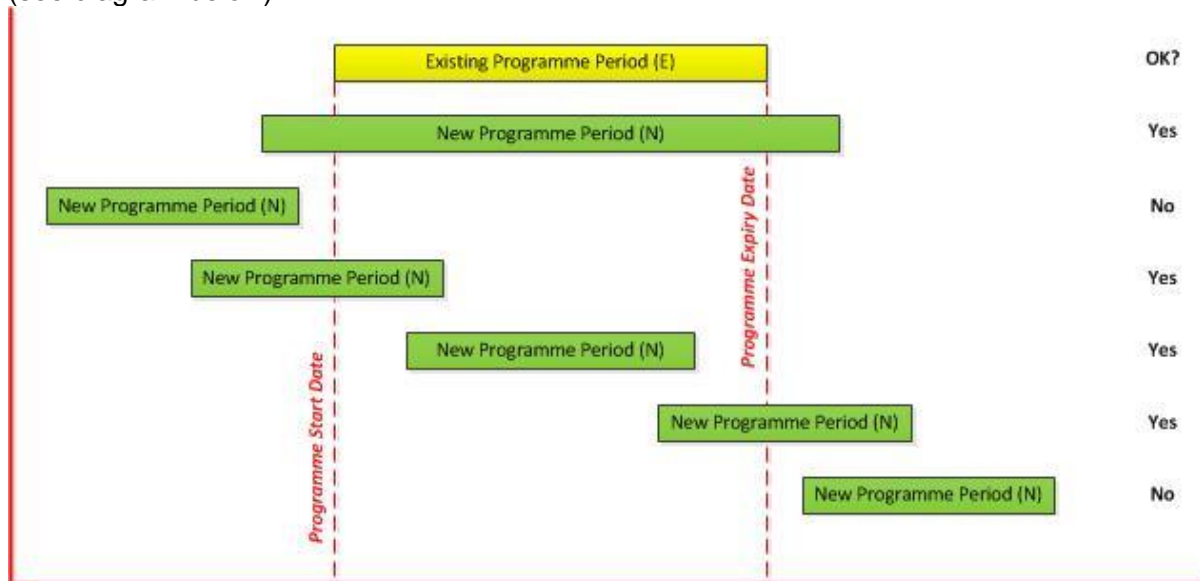

In order to check if the periods overlap in any way use the following formula. It is possible for either the existing programme (E) or the new programme (N) to have no expiry date. Where that is the case then this is set to MAX(date) and the following formula works using this MAX(date).

- **IF** there are no expiry dates on either programme then they WILL overlap and therefore there is no need to check.

ELSE

- (N) Start Date \geq (E) Start Date **AND** (N) Start Date $<$ (E) End Date

OR

- (N) Start Date $<$ (E) Start Date **AND** (N) Expiry Date $>$ (E) Start Date

THEN 'Active' = Yes

Thus far there are four scenarios when we check whether there is an 'Active' programme version:

1. Register new LCP – check that the LCP is active when compared to the latest active version of the target NQ programme
2. Register new version of an LCP - check that the LCP is active when compared to the latest active version of the target NQ programme

3. Register new LCP – check no other LCP programmes have active versions relative to the new LCP which target the same NQ programme
4. Register new version of an LCP - check no other LCP programmes (different programme number) have active versions relative to the new LCP which target the same NQ programme.
5. Local programme names must be unique within the ITO for active programmes i.e. active within the same period as the new programme being registered.

NOTE: This is different to the situation where you are checking if an enrolment is 'Active' (see Section 5.5.3).

5.2.2 TEC approvals process for NZA and MA funded programmes (versions)

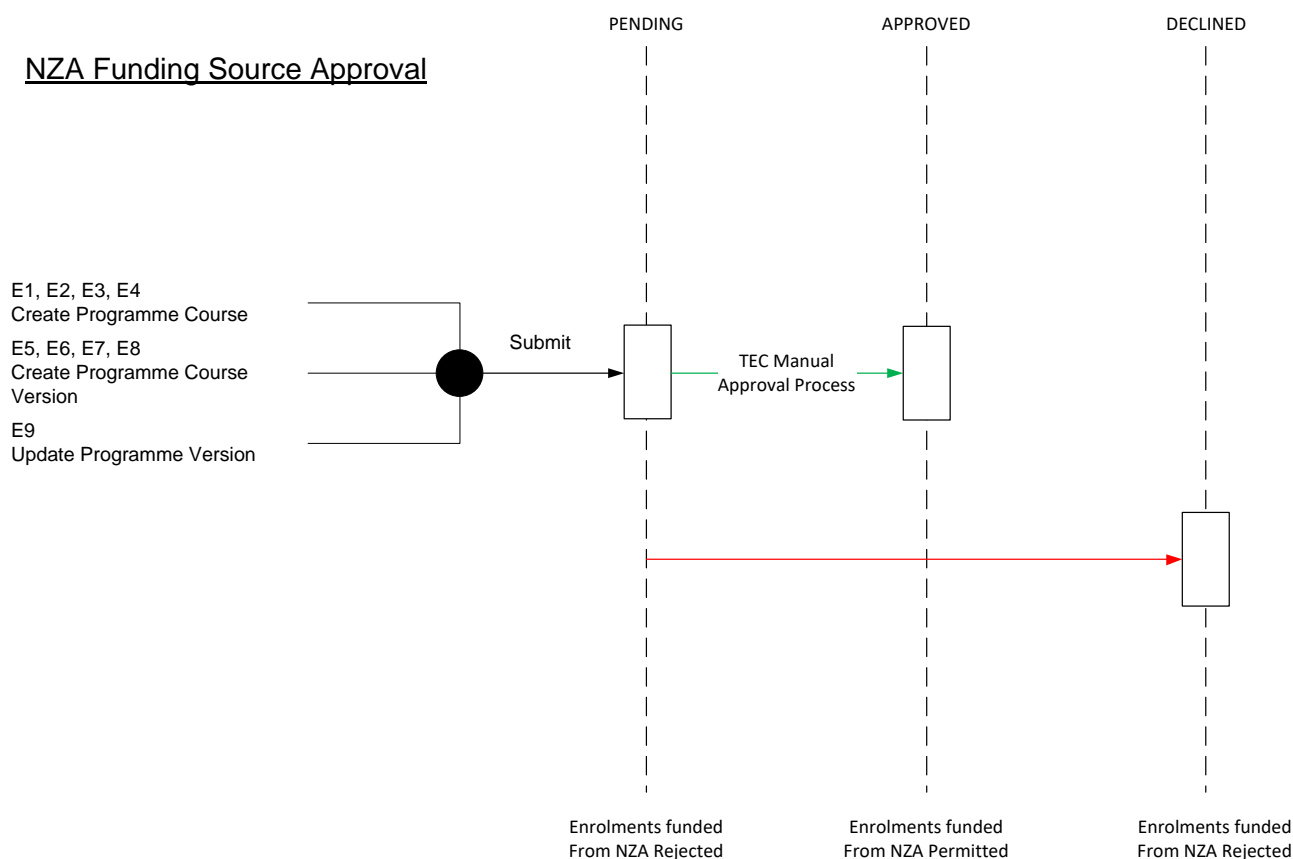

This applies to all CreateProgrammeCourse, CreateProgrammeCourseVersion, and UpdateProgrammeCourseVersion messages where NZA is supplied.

MA Funding Source Approval

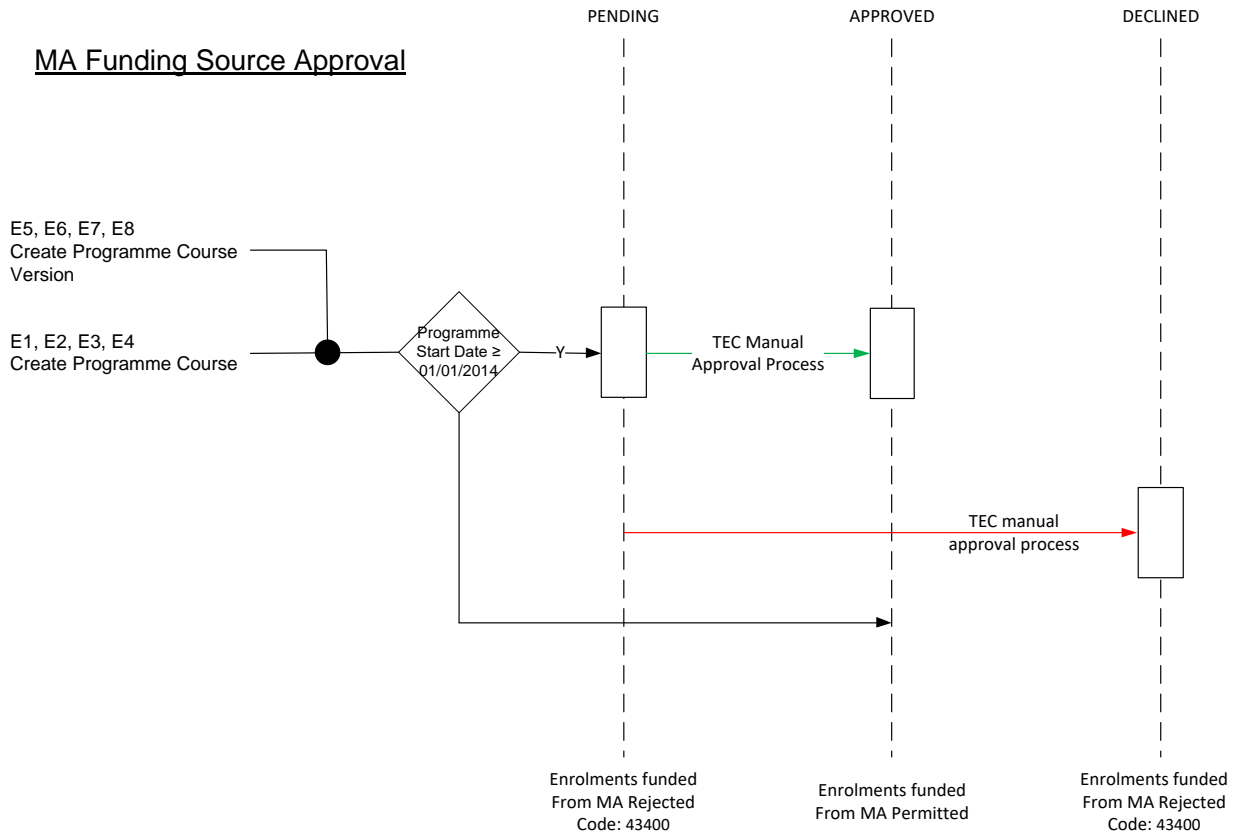

Where the Programme Start Date is greater than or equal to 1/1/14, the MA funded source is set to PENDING and will go through the manual TEC Programme Approval Process.

5.2.3 Common programme elements

The following elements are common to all new Programmes and Courses:

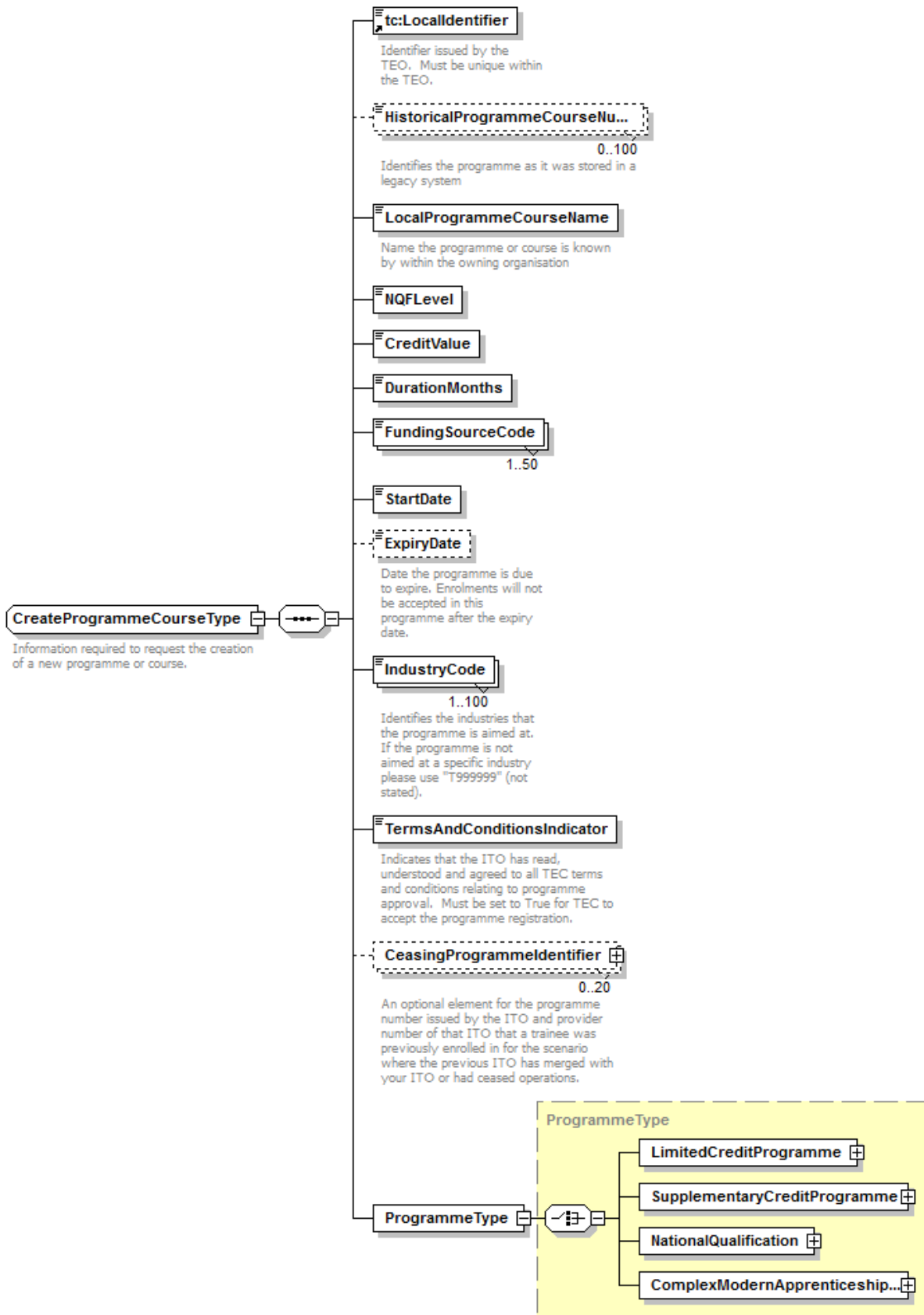

Generated with XMLSpy Schema Editor www.altova.com

The table below describes the common elements in more detail:

Element Name	Cardinality	Data Type	Description
LocalIdentifier	1	Identifier Type	<p>The owning organisations reference for the Programme or Course.</p> <p>Validation:</p> <ol style="list-style-type: none"> 1 Must be unique within the ITO for a programme and all its versions. The ITO cannot have 2 programmes with the same local identifier unless they are versions of the same programme.
Historical ProgrammeCourse Number	0..100	Number Type	<p>If the Programme or Course being registered previously existed on a legacy system, such as ILU, the ITO should supply a reference to the old programme.</p> <p>This allows for tracking of enrolments between ILU and ITR.</p> <p>Validation:</p> <ol style="list-style-type: none"> 1 If provided, must exist in ILU. 2 Must be unique within the new ProgrammeCourse (i.e. no duplicates)
LocalProgramme CourseName	1	NameType	<p>The name by which the ITO refers to the programme or course. This name should follow the TEC naming standards where possible, but can be tailored to the ITOs needs.</p> <p>Validation:</p> <ol style="list-style-type: none"> 1 Must be unique within the ITO. The ITO cannot have 2 “active” programmes with the same name.
NQFLevel	1	xs:int	<p>A number between 1 and 10 that identifies the level on the NQF of the Programme or Course.</p> <p>Validation:</p> <ol style="list-style-type: none"> 1 Where the programme is funded from the Modern Apprenticeship fund (with or without sub-programmes), the NQF level must be greater than or equal to 3. 2 Where there is a strand the level listed on the strand should be used. Where there is not, or the strand ‘0’ is used, then use the level on the qualification.
CreditValue	1	xs:int	<p>The number of credits to be assessed during the programme.</p>

Element Name	Cardinality	Data Type	Description																								
			<p>Validation:</p> <ol style="list-style-type: none"> LCP and SCP must be greater than or equal to 20 credits and no more than 70 credits in total. NQ and complex modern apprenticeship programmes must have a minimum of 40 credits. For all programmes, there must be fewer than or the same as 70 credits per year⁵. LCP programmes may not have 51% or more of the credit value of the target NQ programme. <table border="1"> <thead> <tr> <th>Prog Type</th> <th>Min Credits</th> <th>Max Credits</th> <th>Max Credit Load</th> </tr> </thead> <tbody> <tr> <td>LCP</td> <td>20</td> <td>70</td> <td>160</td> </tr> <tr> <td>National Qualification</td> <td>40</td> <td>-</td> <td>160</td> </tr> <tr> <td>Complex Modern Apprenticeship</td> <td>40</td> <td>-</td> <td>160</td> </tr> <tr> <td>SCP</td> <td>20</td> <td>70</td> <td>160</td> </tr> <tr> <td>NZA</td> <td>40</td> <td>-</td> <td>160</td> </tr> </tbody> </table> <p>Where there is a strand the credit value listed on the strand should be used. Where there is not, or the strand '0' is used, then use the credits on the qualification.</p>	Prog Type	Min Credits	Max Credits	Max Credit Load	LCP	20	70	160	National Qualification	40	-	160	Complex Modern Apprenticeship	40	-	160	SCP	20	70	160	NZA	40	-	160
Prog Type	Min Credits	Max Credits	Max Credit Load																								
LCP	20	70	160																								
National Qualification	40	-	160																								
Complex Modern Apprenticeship	40	-	160																								
SCP	20	70	160																								
NZA	40	-	160																								
DurationMonths	1	xs:int	<p>The number of whole months the programme takes to complete.</p> <p>Validation:</p> <ol style="list-style-type: none"> Minimum duration may vary by programme type. Current minimums⁶ are: <ul style="list-style-type: none"> LCP – 4 month National Qualification – 7 month Complex Modern Apprenticeship –7 month 																								

⁵ (credits/duration months) x12

⁶ Based on the credit load, these are the minimum months which a programme could run (at minimum credit value)

Element Name	Cardinality	Data Type	Description										
			<ul style="list-style-type: none"> SCP – 4 month <p>Duration is used to calculate a programmes' credit per year, please see restriction above on credits per year.</p>										
FundingSourceCode	1..50	CodeType	<p>Identifies the funds from which TEC will fund enrolments in a programme. Must have at least one fund but may have multiple.</p> <p>Validation:</p> <p>1 Must match one of the values below:</p> <table border="1"> <thead> <tr> <th>Value</th> <th>Description</th> </tr> </thead> <tbody> <tr> <td>IT</td> <td>Industry training fund</td> </tr> <tr> <td>MA</td> <td>Modern Apprenticeship fund</td> </tr> <tr> <td>TA</td> <td>Trade Academy</td> </tr> <tr> <td>NZA</td> <td>New Zealand Apprenticeship</td> </tr> </tbody> </table> <p>2 Funding source for the programme cannot be duplicated e.g. it would be invalid to list "IT" twice.</p> <ul style="list-style-type: none"> If the programme is a LCP or SCP, the funding source must be "IT" only or "TA" only or "IT" and "TA". If the programme is a Complex Modern Apprenticeship, the funding source may be "MA" or "NZA". If the programme is a National Qualification, the funding source must be "IT" only or "TA" only or "IT" and "TA". If the funding source code is "NZA" it is to follow the same rules as MA If the funding source code is "NZA" the approval process occurs outside of the ITR Further to this, the NQ can optionally be additionally funded by "MA" and / or "NZA". The NQ must not be solely funded by "MA" or "NZA" as it is not possible to have "MA" or "NZA" only funded NQ programmes. 	Value	Description	IT	Industry training fund	MA	Modern Apprenticeship fund	TA	Trade Academy	NZA	New Zealand Apprenticeship
Value	Description												
IT	Industry training fund												
MA	Modern Apprenticeship fund												
TA	Trade Academy												
NZA	New Zealand Apprenticeship												
StartDate	1	DateType	<p>Date from which the programme is available for use.</p> <p>Validation:</p>										

Element Name	Cardinality	Data Type	Description
			<ol style="list-style-type: none"> 1 StartDate < ExpiryDate (where it is supplied). 2 Start Date for MA on or after 01/01/2014 will go into pending and be manually approved by TEC
ExpiryDate	0..1	DateType	<p>Date on which the programme ceases to be available for enrolments. Any enrolments attempted after this date will be rejected.</p> <p>Validation:</p> <ol style="list-style-type: none"> 1 ExpiryDate > StartDate. 2 ExpiryDate >= Today 3 Once expiry date has passed it cannot be updated.
IndustryCode	1..100	CodeType	<p>Each programme must identify the industry or industries the programme is intended for.</p> <p>IndustryCode (ANSIC) is defined by Statistics New Zealand and identifies the industry the trainee is primarily working in.</p> <p>Validation:</p> <ol style="list-style-type: none"> 1 Must match a code from level 4 of the industry classification. 2 Must be unique within the programme i.e. that same industry code cannot be listed more than once for a given programme.
TermsAndConditions Indicator	1	Indicator Type	See section 2.2 for details.
ProgrammeType	1	Complex	<p>Identifies the type of programme or course being defined and lists specific elements that relate to each type or programme or course. There are 4 different types:</p> <p>LimitedCreditProgramme (LCP), an introductory programme intended to introduce a trainee to a specific national qualification and lead to enrolment in, and completion, of that qualification. See section 5.2.4 for details.</p> <p>SupplementaryCreditProgramme (SCP), a programme that adds to an existing qualification already held by the trainee. See section 5.2.5 for details.</p> <p>NationalQualification (NQ), a single training programme or modern apprenticeship</p>

Element Name	Cardinality	Data Type	Description
			<p>programme that leads to a national qualification. See section 5.2.6 for details.</p> <p>ComplexModernApprenticeship, a modern apprenticeship programme that contains sub-programmes and/or additional unit standards. See section 5.2.7 for details.</p>
CeasingProgramme Identifier	0..20	Complex	<p>See section 4.6 for details</p> <p>Additional Validation:</p> <p>The supplied EDUMIS for both ITOs must exist and be linked</p> <p>The Programme Local Identifier must exist and identify a Programme at the ceasing Organisation (identified by the EDUMIS supplied)</p> <p>The EDUMIS and Programme ID supplied must not have been linked to by any other ITO or from a different programme at the same ITO.</p>

5.2.3.1 Validation flow diagram

Validate Basic Programme

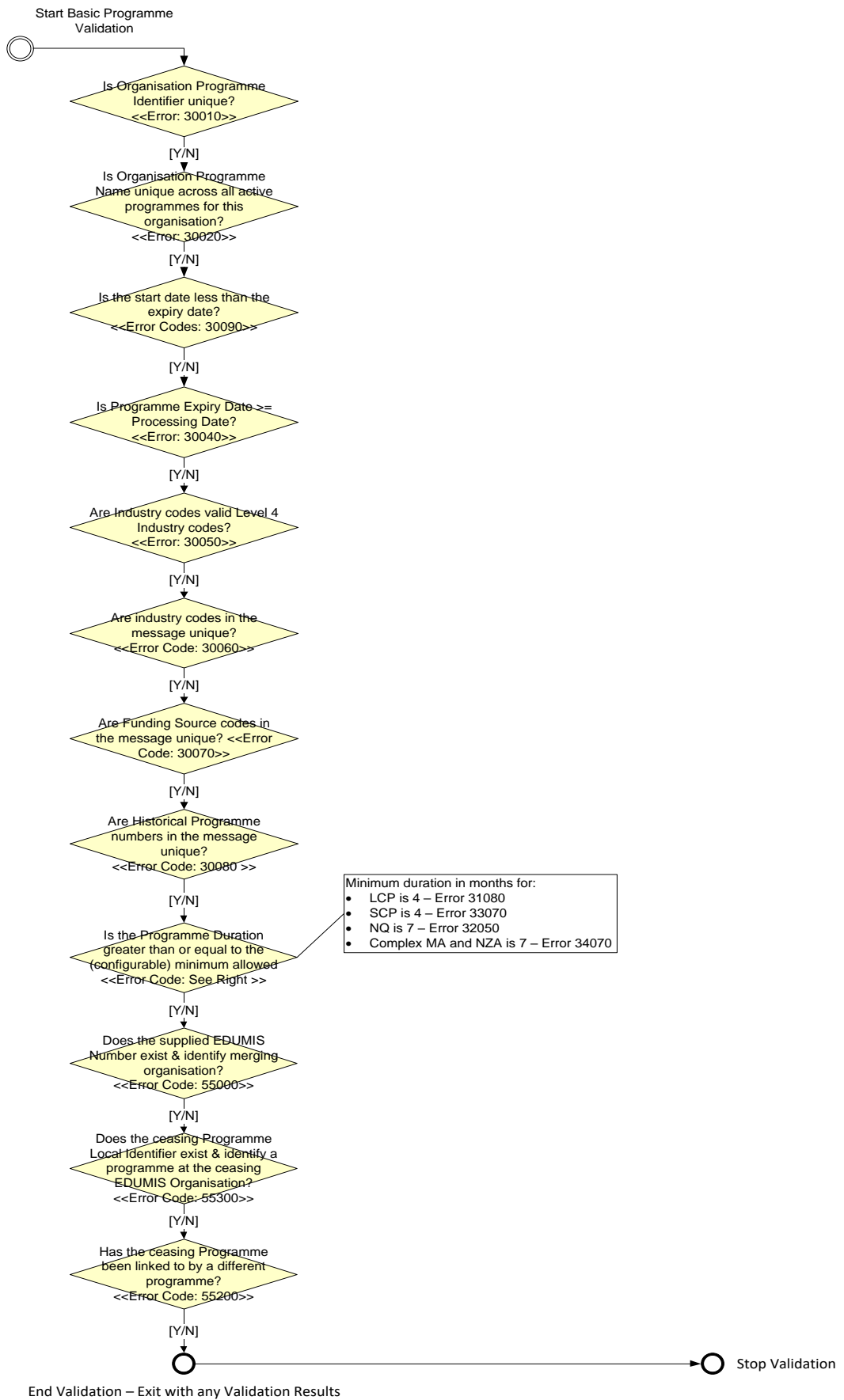

5.2.4 Limited credit programme (E1)

A LCP is a programme designed to introduce a trainee to a programme and is intended to lead to the trainee enrolling in a full programme once the LCP is completed. Elements required specifically for LCPs are shown in the diagram below:

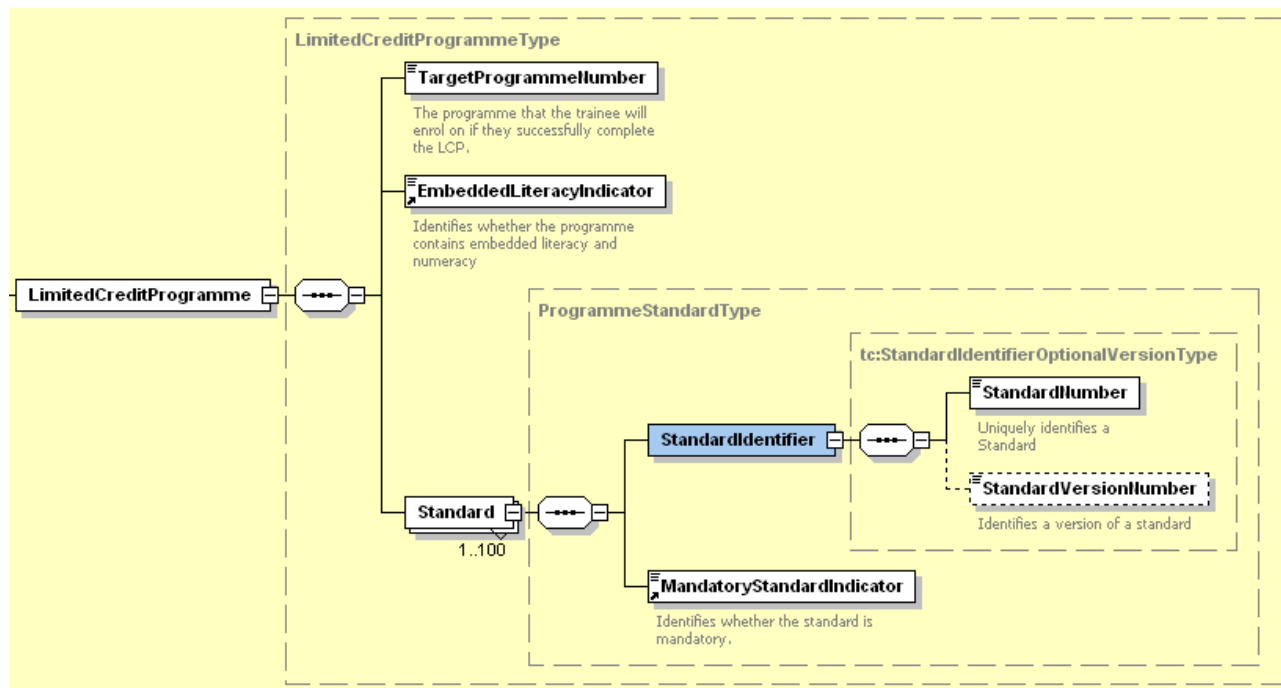

The elements for a LimitedCreditProgramme are described in more detail below:

Element Name	Cardinality	Data Type	Description
TargetProgramme Number	1	Sequence Type	<p>A character string, normally of numbers, that uniquely identifies the Programme the LCP leads to.</p> <p>Validation:</p> <ol style="list-style-type: none"> 1 Must match an existing industry training programme for the ITO registering the LCP programme. 2 This target programme must be a National Qualification programme i.e. not an LCP, SCP, NZA or complex MA. 3 This target programme must be Active. 4 The target programme cannot have any other existing Active LCP programmes. 5 The LCP programme funding source code(s) must be the same as or a subset of the funding source codes for the target programme.
EmbeddedLiteracy NumeracyIndicator	1	Indicator Type	A Boolean (true/false) that indicates whether the programme contains embedded literacy and numeracy content.

Element Name	Cardinality	Data Type	Description
			<p>Validation:</p> <p>1 This must be either 'True' or 'False'.</p>
Standard	1..100	Complex	<p>A list of standards that may be assessed as part of the programme.</p> <p>See section 4.5.1 for details</p> <p>Validation:</p> <p>If standard number and standard version number is supplied, it must be unique within the message i.e. a standard and version may not appear more than once within the same programme.</p> <p>OR</p> <p>If standard number is supplied and standard version number is not supplied, the standard number must only be listed once.</p>
Mandatory StandardIndicator	1	Indicator Type	<p>Identifies whether the trainee must have achieved the standard to complete the programme.</p> <p>Validation:</p> <p>1 Must be either 1 (mandatory) or 0 (optional)</p>

5.2.4.1 Validation flow diagram

Validate Limited Credit Programme (LCP) Activity Diagram

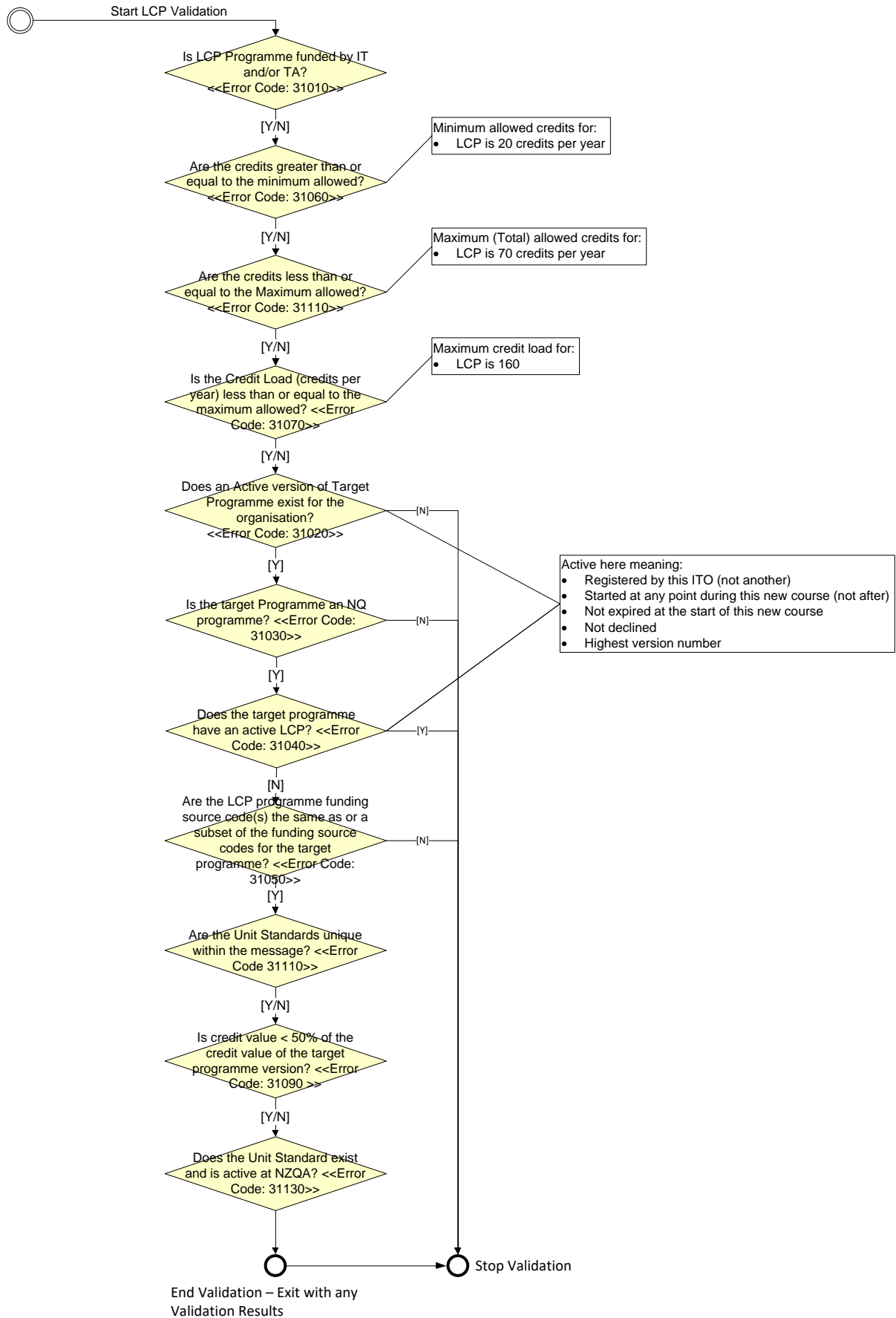

5.2.5 Supplementary credit programme (SCP) (E2)

An SCP is designed to allow a trainee to achieve an additional qualification or unit standards in addition to a qualification they already hold. For example, a trainee may already hold a qualification but then enrol in an SCP to achieve an additional strand.

The diagram below describes the elements required for an SCP:

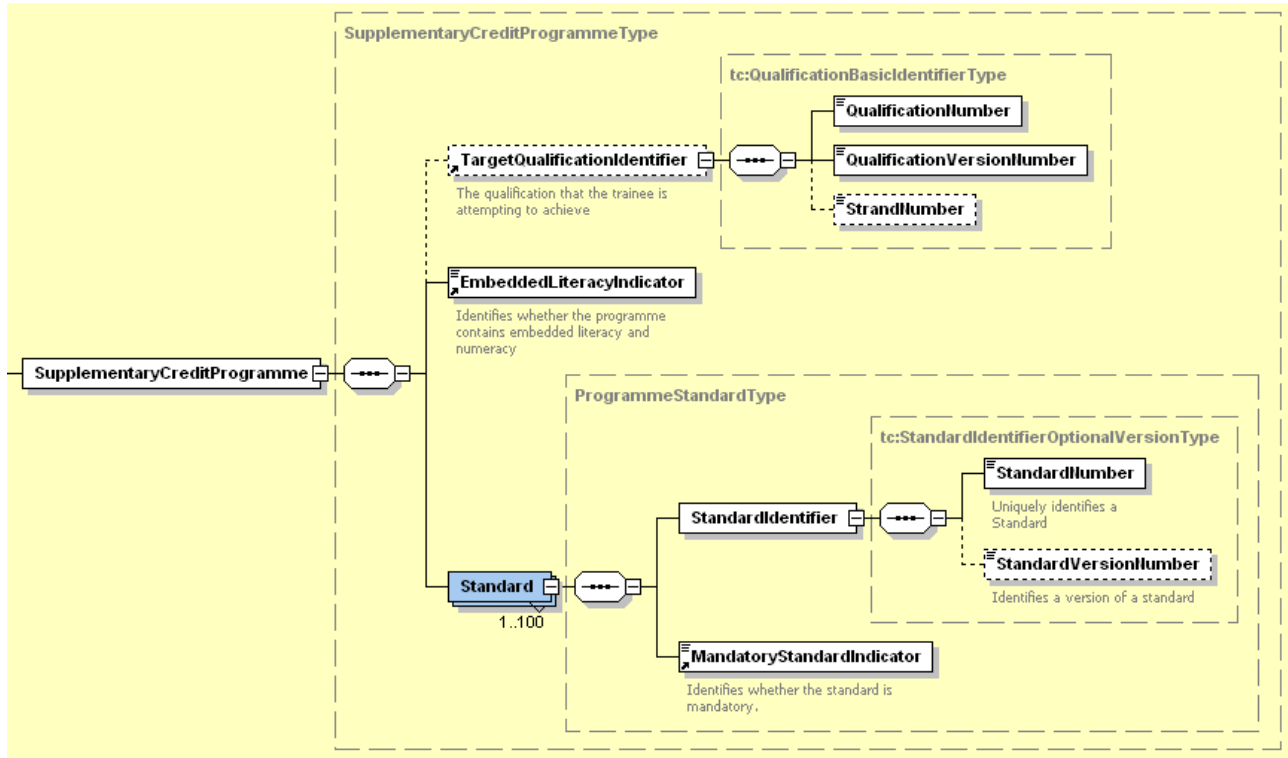

The table below describes the elements required for an SCP in more detail:

Element name	Cardinality	Data type	Description
TargetQualification Identifier	0..1	Complex	Identifies the qualification and strand the SCP is designed to attain. Only required if the programme leads to a specific qualification and strand. See section 4.4 for details.
EmbeddedLiteracy NumeracyIndicator	1	Indicator Type	Identifies whether the programme contains embedded literacy or numeracy. See section 5.3.1 for details.
Standard	1..100	Complex	A list of standards that will be assessed as part of the programme. See section 4.5.1 for details. Validation: 1 If standard number and standard version number is supplied, it must be unique within the message i.e. a standard and version may not appear more than once within the same programme.

Element name	Cardinality	Data type	Description
			<p>OR</p> <p>If standard number is supplied and standard version number is not supplied, the standard number must only be listed once.</p>
Mandatory StandardIndicator	1	Indicator Type	<p>Identifies whether the trainee must have achieved the standard to complete the programme.</p> <p>Validation:</p> <p>1 Must be either 1 (mandatory) or 0 (optional)</p>

5.2.5.1 Validation flow diagram

The diagram below shows the order of the validations applied to SCPs (in addition to the general programme-related checks):

Validate Supplementary Credit Programme (SCP) Activity Diagram

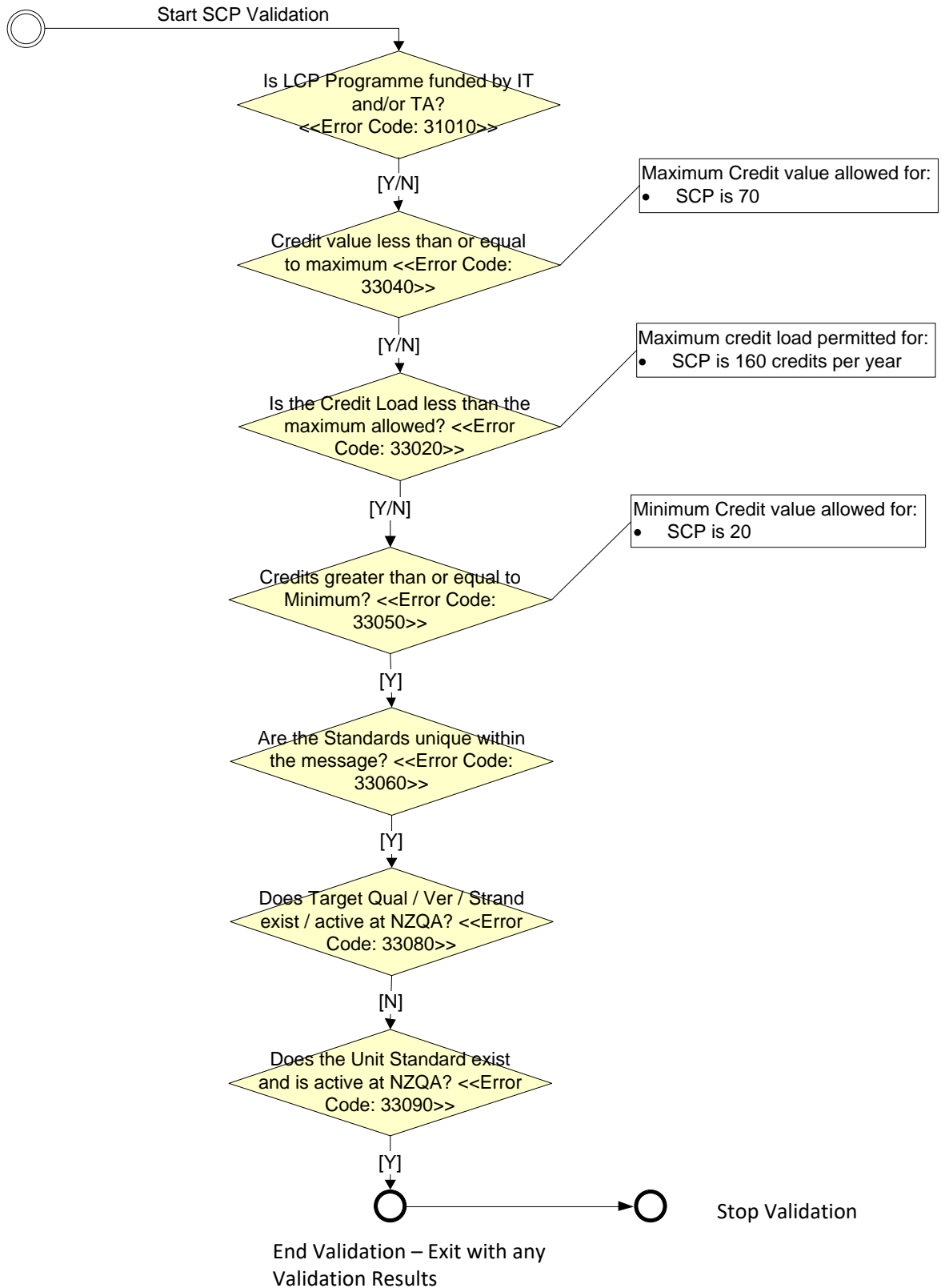

5.2.6 National qualification (NQ) (E3)

An NQ Programme is any Industry Training Programme or Modern Apprenticeship that leads directly to the achievement of a qualification registered on the NQF. An NQ Programme may be offered to either Industry Trainees or Modern Apprentices depending on the funding source (see section 5.2.3 for details).

The diagram below describes elements specific to an NQ Programme:

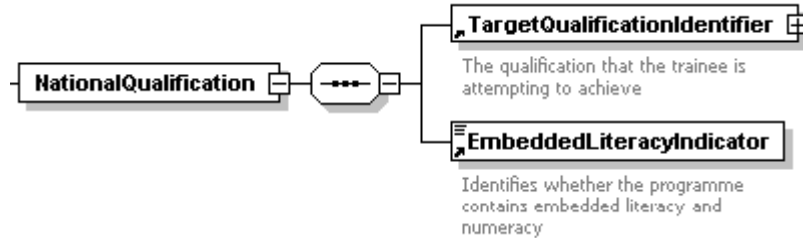

The table below describes the elements of an NQ Programme in more detail:

Element name	Cardinality	Data type	Description
TargetQualification Identifier	1	Complex	Identifies the qualification and strand that the NQ is designed to attain. See section 4.4 for details. Validation: 1 The qualification must be registered on the National Qualifications Framework.
EmbeddedLiteracy NumeracyIndicator	1	Indicator Type	Identifies whether the programme contains embedded literacy or numeracy. See section 5.3.1 for details.

5.2.6.1 Validation flow diagram

Validate National Qualification Activity Diagram

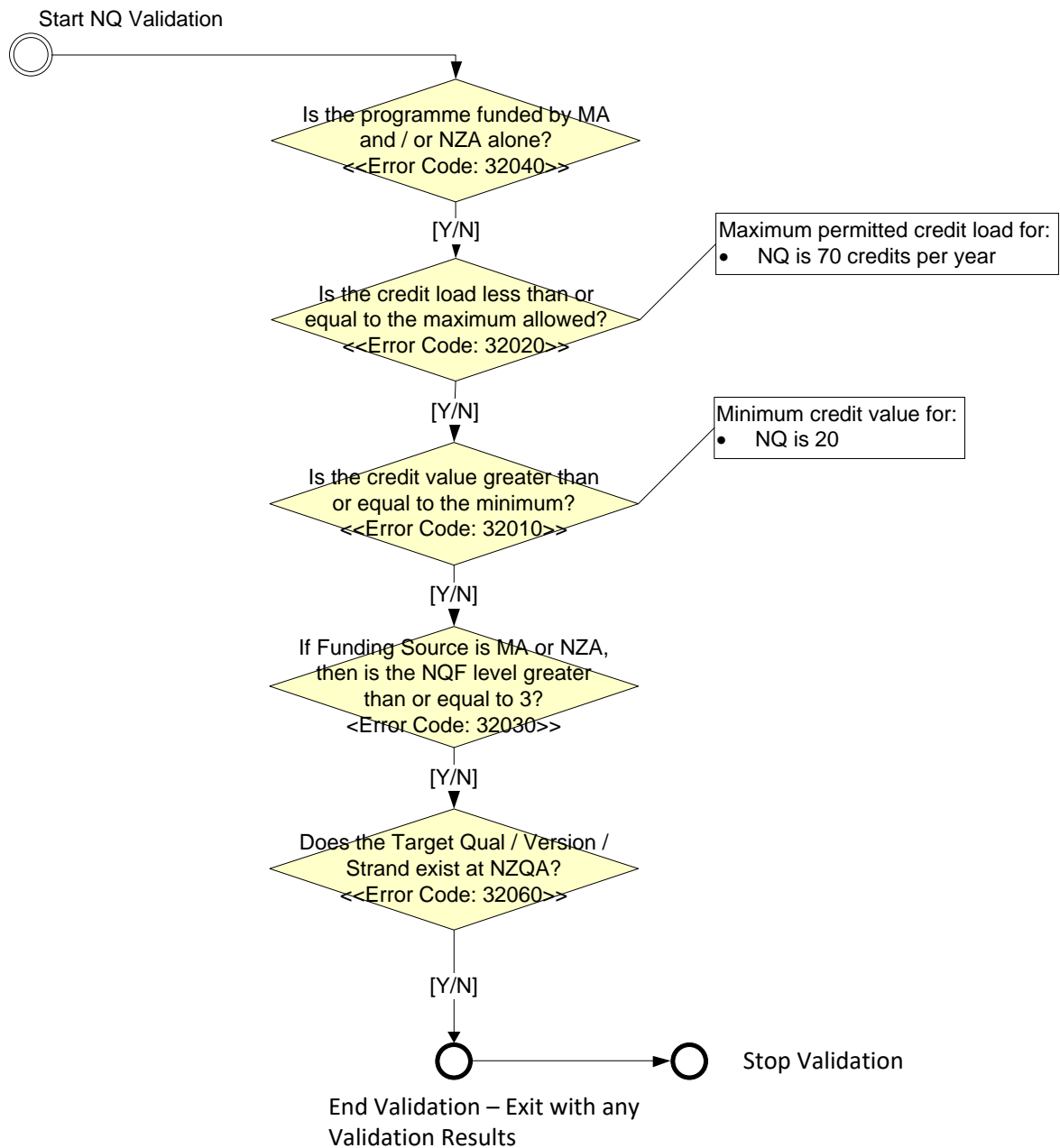

5.2.7 Micro credentials (MC)

Micro-credentials are new stand-alone education products intended to enable learners to access specific knowledge and skills in a cost-effective and time-efficient way. They are smaller than qualifications and focus on skill development opportunities not currently catered for in the tertiary education system, and for which there is strong evidence of need by industry, employers, iwi and community.

At a minimum, micro-credentials will be subject to the same requirements as training schemes or assessment standards and will also be required to:

- be 5 – 40 credits in size
- have strong evidence of need from employers, industry and/or community

- not duplicate current quality assured learning approved by NZQA
- be reviewed annually to confirm they continue to meet their intended purpose.

When creating a new programme in the ITR for your micro-credential, please use the programme type SCP (supplementary credit programme). To allow micro-credentials to be reported this way, we have relaxed the validation rules in the ITR for SCPs. The minimum duration you can select is 1 month and the minimum credits is 5.

You will also need to select a target qualification. Anything that is entered without a target qualification will be treated as an SCP.

All SCP submissions will be monitored for any programmes submitted that are outside of MC or SCP requirements.

5.2.8 Complex modern apprenticeship and New Zealand apprenticeship (E4)

Some Modern Apprenticeship programmes are designed to be an umbrella for a collection of Industry Training Programmes that are undertaken simultaneously. In this case there is typically a significant qualification that the MA or NZA programme is designed to achieve, and one or more other qualifications that can be achieved, as the apprentice progresses through the programme. Complex programmes will consist of at least one approved industry training programme and additional unit standards when necessary to provide a balanced MA or NZA programme.

When attempting to register an MA or NZA programme that contains other programmes, the ITO must first register the programmes that are to be included in the umbrella modern apprenticeship programme.

Note: A sub-programme for a Complex MA must have a funding source of IT and MA (not IT only). This will be managed by the TEC external to the ITR.

A request to register a MA programme with sub components includes the elements described in section 5.2.3 plus those shown in the diagram below:

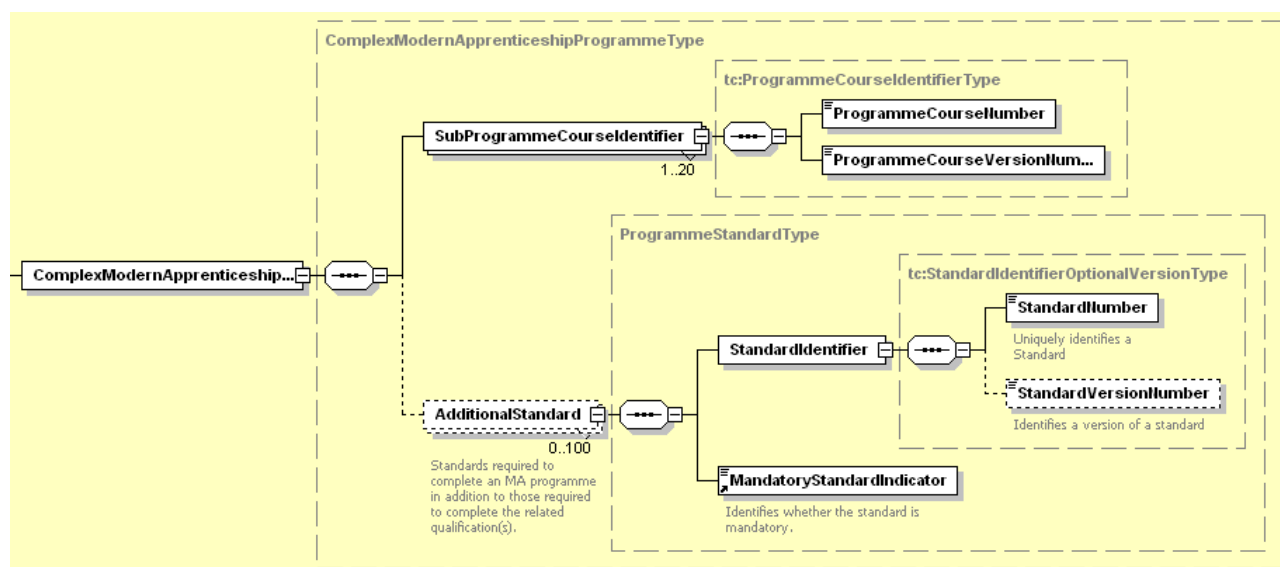

The table below describes the elements in more detail:

Element name	Cardinality	Data type	Description
SubProgramme CourseIdentifier	1..20	Complex	<p>Identifies the programmes that make up the modern apprenticeship programme. See section 4.3 for a description of programme identifier.</p> <p>Validation:</p> <ol style="list-style-type: none"> 1 Sub-programmes must be unique. 2 If there is only one sub-programme, there must be additional unit standards otherwise this is a National Qualification programme. 3 Sub-programmes may only be of type NQ. 4 Sub-programmes must exist for this ITO.
AdditionalStandard	0..100	Complex	<p>Some modern apprenticeship programmes may specify additional standards to be assessed over and above those required to complete the qualifications specified in sub-programmes.</p> <p>See section 4.5.1 for the basic validation rules.</p> <p>Validation:</p> <p>If standard number and standard version number, it must be unique within the message i.e. a standard and version may not appear more than once within the same programme.</p> <p>OR</p> <p>If standard number is supplied and standard version number is not supplied, the standard number must only be listed once.</p>
Mandatory StandardIndicator	1	Indicator Type	<p>Identifies whether the trainee must have achieved the standard to complete the programme.</p> <p>Validation:</p> <ol style="list-style-type: none"> 1 Must be either 1 (mandatory) or 0 (optional)
FundingSourceCode	1..50	CodeType	See section 5.2.3 for details

5.2.8.1 Validation flow diagram

Validate Complex Modern Apprenticeship and NZA Programme Activity Diagram

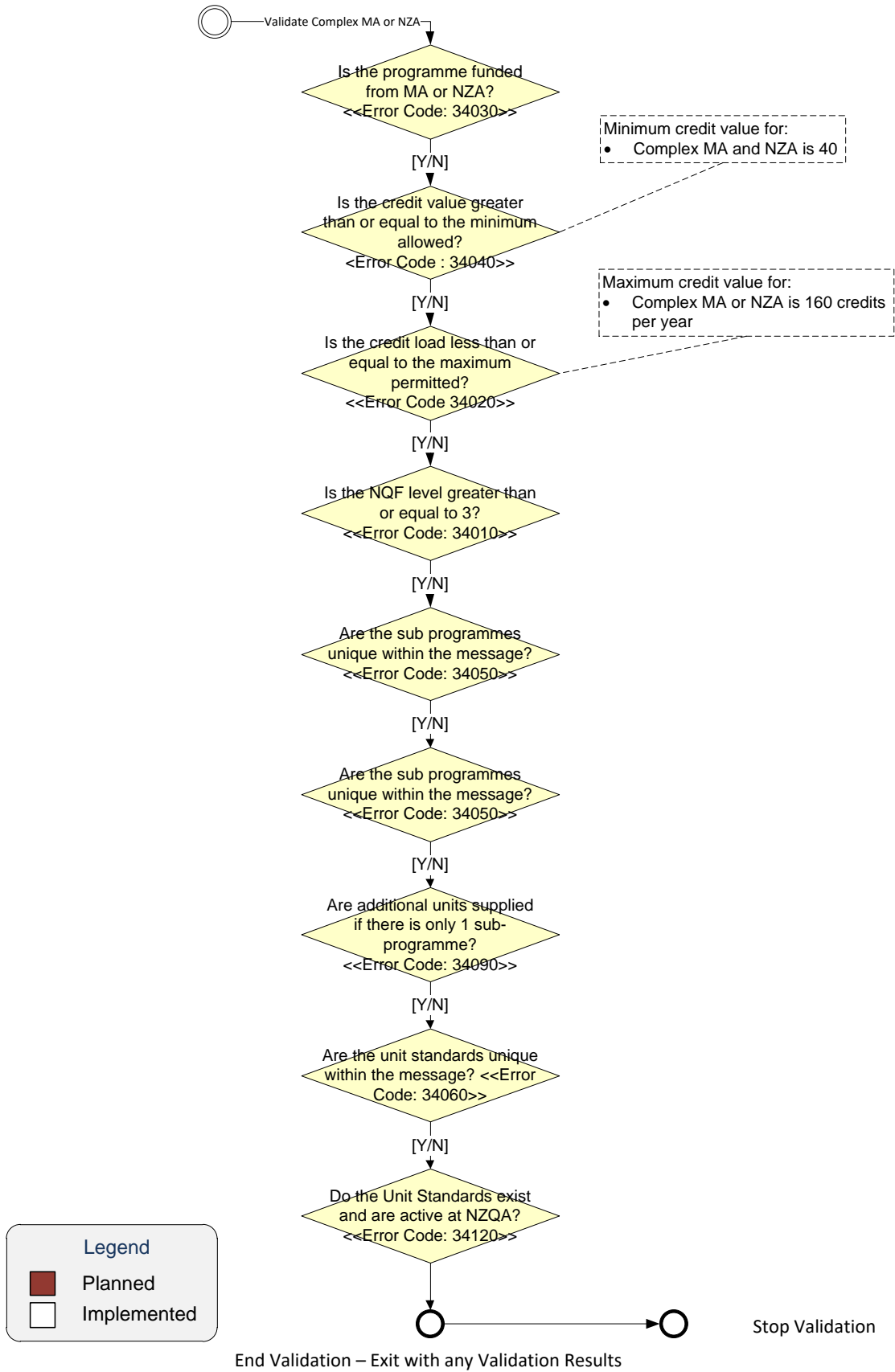

5.3 Create new version of a programme course

Over time an ITO may amend their programmes to better suit their industry or as a result of changes to the related qualifications. To inform the TEC of such changes the TMS will register a new version of the programme.

The elements required to register a new version of a programme are largely the same as those required to register a new programme (see section 5.2 for details).

Some changes to programme information constitute the need for a new version and some will only need an update to the current version. This table details the situations when a new version will be required. Updates have yet to be fully determined.

Item to be changed	New programme	New version	Update
Local identifier	✓	Not allowed	Not allowed
TEC Programme Number	N/A	Not allowed	Not allowed
Historical programme course number	✓	✓	Not allowed
ITO (Local) programme course name	✓	✓	Not allowed
NQF level	✓	Not allowed	Not allowed
Credit Value	✓	✓	Not allowed
Duration Months	✓	✓	Not allowed
Funding source code	✓	✓	Not allowed
Start Date	✓	✓	Not allowed
Expiry date	✓	✓	✓
Industry code	✓	✓	Not allowed
Programme Type	✓	Not allowed	Not allowed
Terms and Conditions Indicator	N/A	Not allowed	Not allowed
Embedded literacy indicator	✓	✓	Not allowed
Target Programme Number	✓	✓	Not allowed
Target Programme Version	✓	✓	Not allowed
Target Qual # or Strand	✓	✓	Not allowed
Target Qual Version #	✓	✓	Not allowed
Add/remove/change standard or standard version	✓	✓	Not allowed
Sub-programme Number	✓	Not allowed	Not allowed

Item to be changed	New programme	New version	Update
Sub-programme Version	✓	✓	Not allowed
Ceasing Programme Identifier	✓	✓	✓

The following sections describe the elements and validation rules for registering a new version of a programme. Validation applies as per creating a new programme unless listed below.

5.3.1 Common programme elements

The diagram below shows the structure of a CreateProgrammeCourseVersion message:

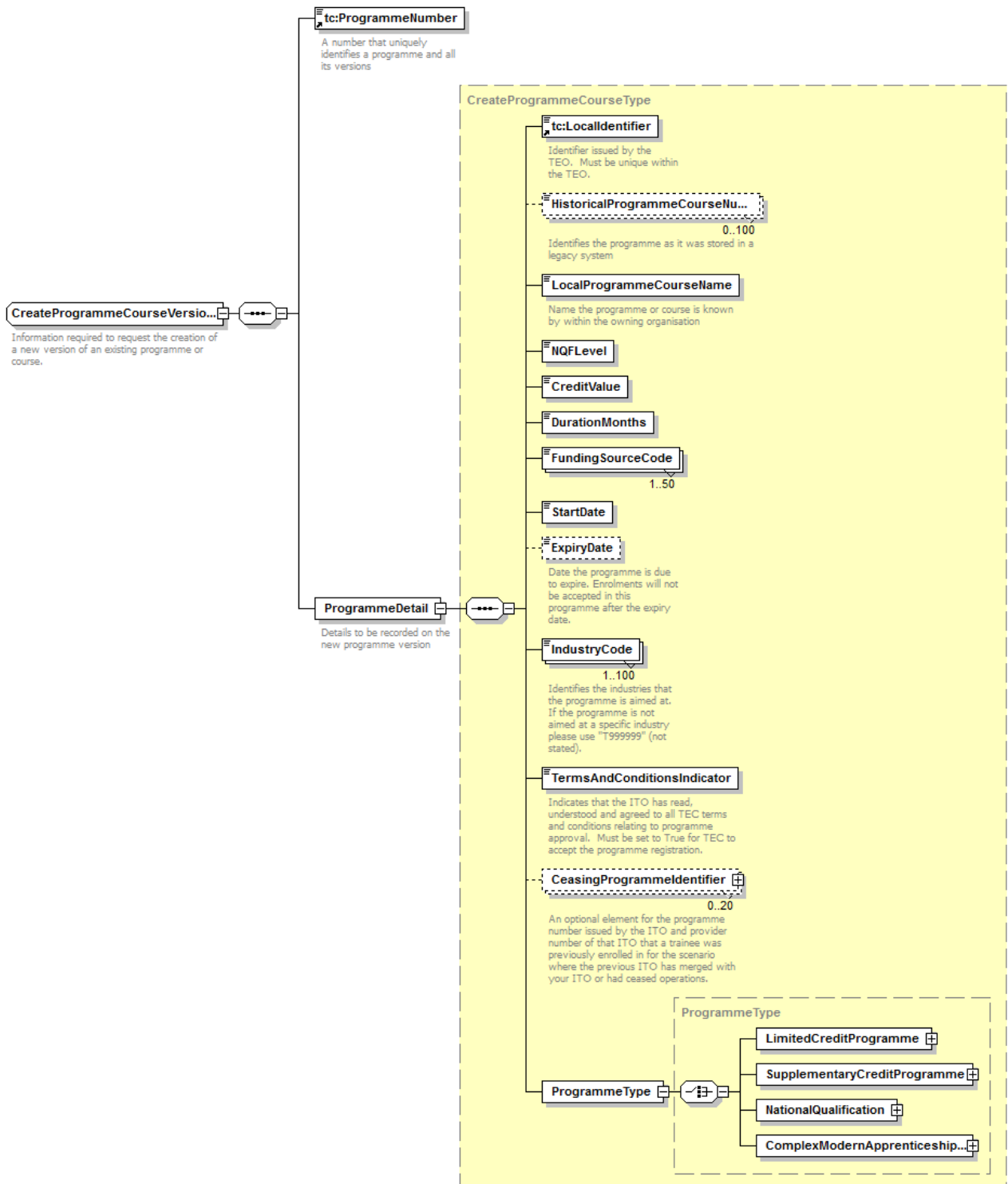

Generated with XMLSpy Schema Editor www.altova.com

The table below describes each element of the message in more detail:

Element name	Cardinality	Data type	Description
ProgrammeNumber	1	Number Type	A TEC issued number that identifies an approved training programme. Note: This will be returned as an object identifier following the successful processing of a Create Programme Course message.
ProgrammeDetails	1	Complex	The details of the new programme version
LocalIdentifier	1	Identifier Type	The owning organisations reference for the Programme or Course. Validation: 1 Must match the local ID sent with the first version of the programme registered.
Historical ProgrammeCourse Number	0..100	Number Type	See section 5.2.3 for details
LocalProgramme CourseName	1	NameType	See section 5.2.3 for details
NQFLevel	1	xs:int	See section 5.2.3 for details
CreditValue	1	xs:int	See section 5.2.3 for details
DurationMonths	1	xs:int	See section 5.2.3 for details
FundingSourceCode	1..50	CodeType	The TEC manual programme approval process will apply to this message for all NZA-funded programme course versions and the MA-funded programme course versions where the start date is greater than or equal to 01/01/2014 See section 5.2.3 for details
StartDate	1	DateType	See section 5.2.3 for details
ExpiryDate	0..1	DateType	See section 5.2.3 for details
IndustryCode	1..100	CodeType	See section 5.2.3 for details
TermsAndConditions Indicator	1	Indicator Type	See section 5.2.3 for details
ProgrammeType	1	Complex	See section 5.2.3 for details. Validation: 1 Must be the same as per a previous version of the programme.
CeasingProgramme Identifier	0..20	Complex	See section 4.6 for details Additional Validation:

Element name	Cardinality	Data type	Description
			<p>The supplied EDUMIS for both ITOs must exist and be linked</p> <p>The Programme Local Identifier must exist and identify a Programme at the ceasing Organisation (identified by the EDUMIS supplied)</p> <p>The EDUMIS and Programme ID supplied must not have been linked to by any other ITO or from a different programme at the same ITO.</p> <p>Have all previously supplied ceasing programme identifiers been supplied if there are existing enrolments for that programme version?</p>

5.3.1.1 Additional validation rules

In addition to the element specific validation rules listed in the section above please note the following:

1. Only the ITO that registered the original programme (the “owning ”ITO) may create a new version of a programme.

5.3.1.2 Validation flow diagram

Validate Basic Programme Version

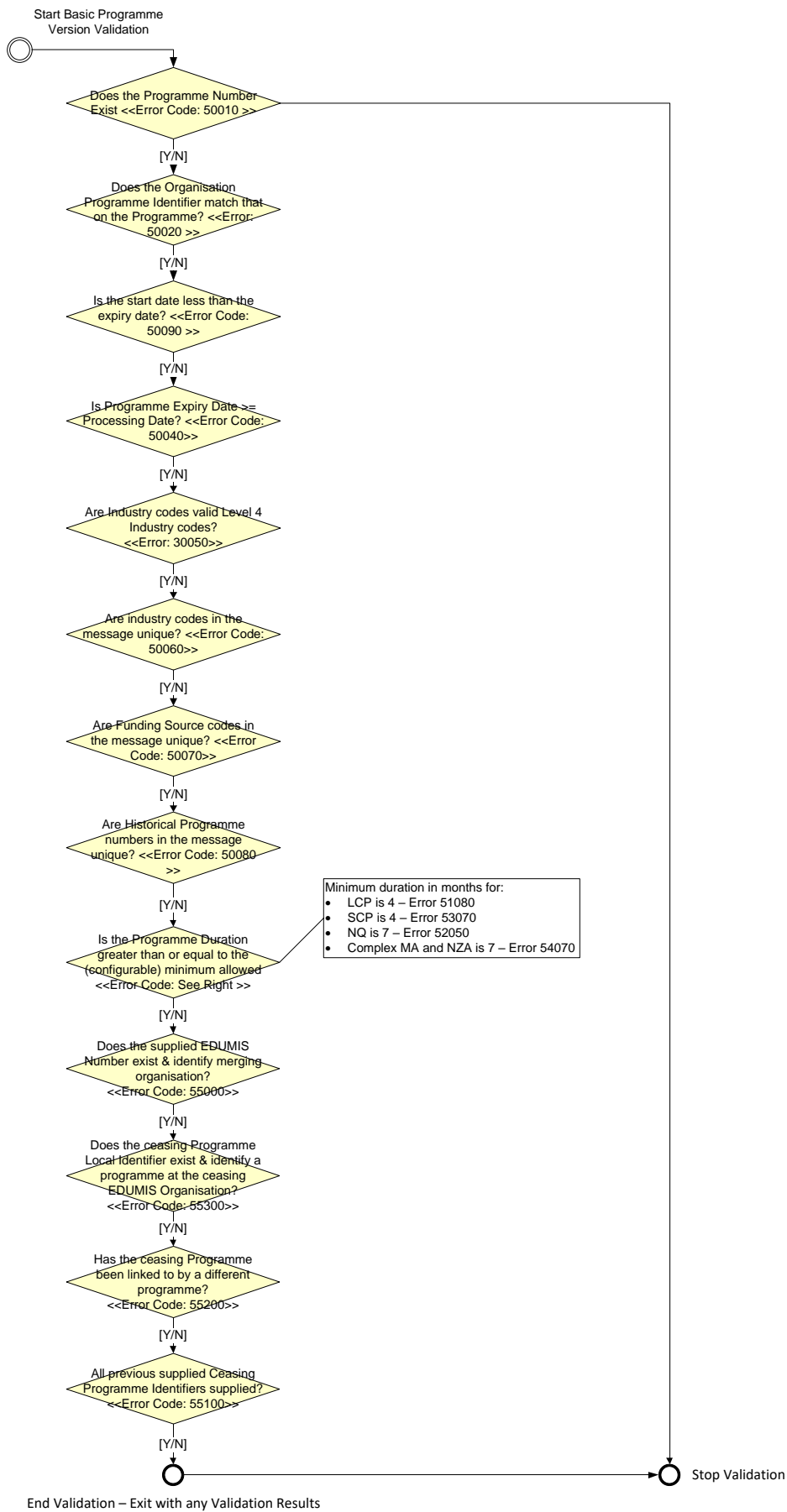

5.3.2 Limited credit programme (E5)

Creating a new version of a Limited Credit Programme uses the same structure and validation rules as described in section 5.2.4.

5.3.2.1 Validation flow diagram

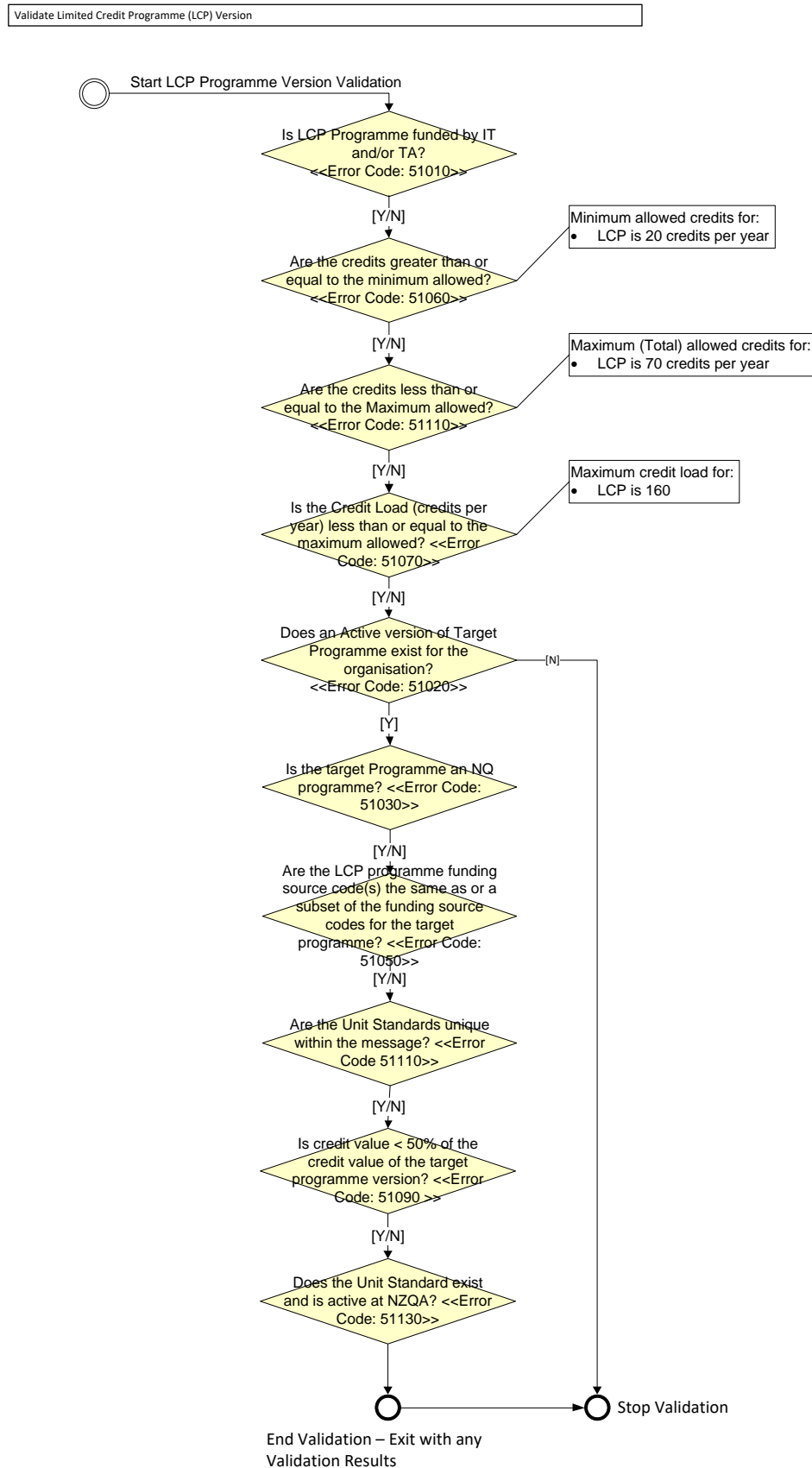

5.3.3 Supplementary credit programme (E6)

The structure for registering a new version of a SCP is the same as that described in section 5.2.5.

5.3.3.1 Additional validation rules

In addition to the element specific validation rules listed in the section above please note the following:

Element name	Cardinality	Data type	Description
TargetQualification Identifier	0..1	Complex	See section 5.2.5 for basic validation rules. Additional validation: <ol style="list-style-type: none">1 Target qualification number may be different to that which was specified in the preceding programme version.2 Target Qualification Version Number may be different from previous programme version.3 Target strand may be different from the preceding programme version
EmbeddedLiteracy NumeracyIndicator	1	Indicator Type	See section 5.2.5 for basic validation rules.
Standard	1..100	Complex	See section 5.2.5 for basic validation rules.

5.3.3.2 Validation flow diagram

Validate Supplementary Credit Programme (SCP Version)

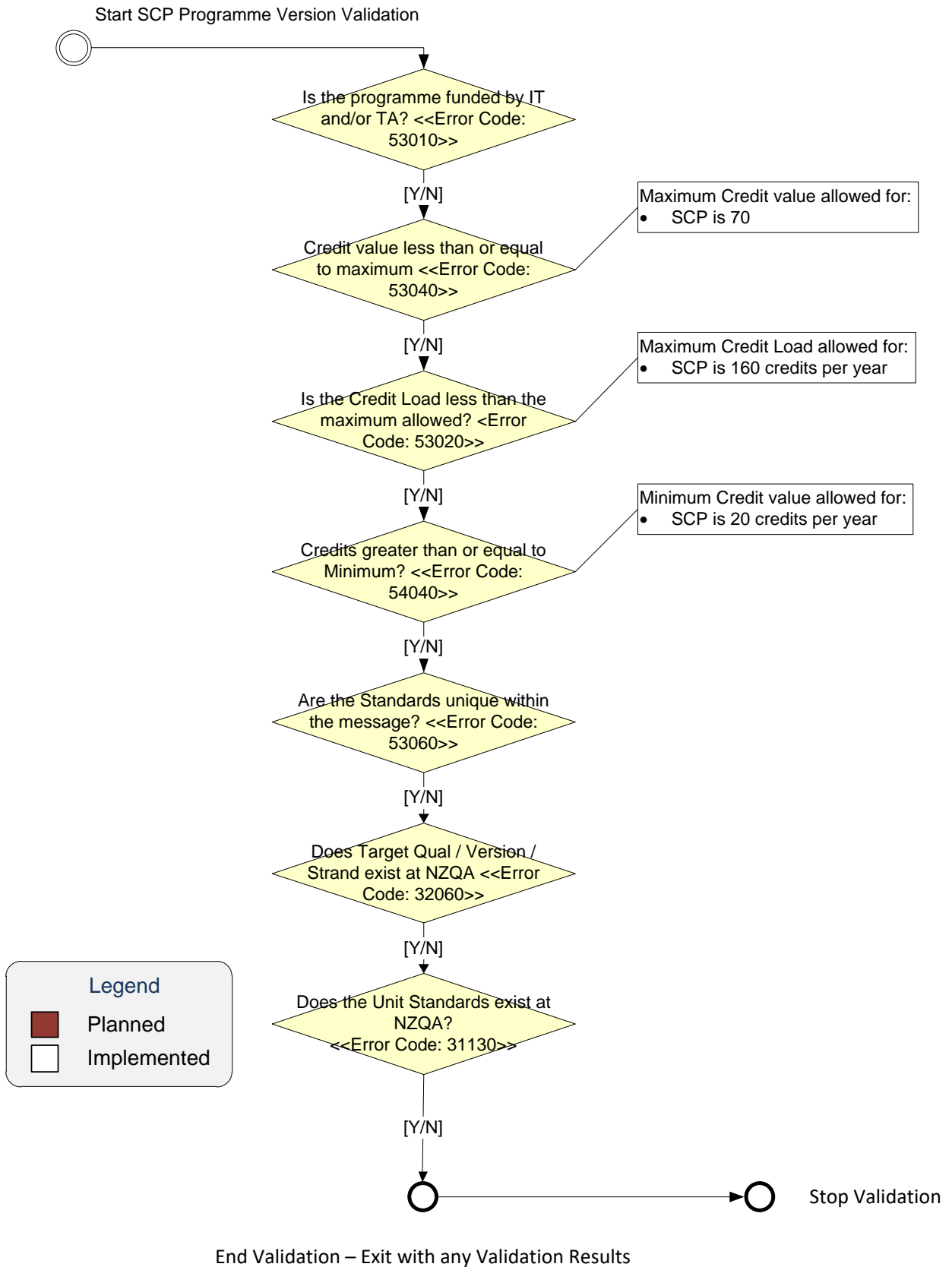

5.3.4 National qualification (NQ) (E7)

The structure required to register a new version of a National Qualification (NQ) programme is the same as that described in section 5.2.6. The table below describes additional validations that apply to new NQ programme versions.

Element name	Cardinality	Data type	Description
TargetQualification Identifier	1	Complex	<p>See section 5.2.6 for details.</p> <p>Validation:</p> <ol style="list-style-type: none">1 Target qualification number may be different to that which was specified in the preceding programme version.2 Target Qualification Version Number may be different from previous programme version.3 Target strand may be different from the preceding programme version

5.3.4.1 Validation flow diagram

Validate National Qualification Programme (NQ Version)

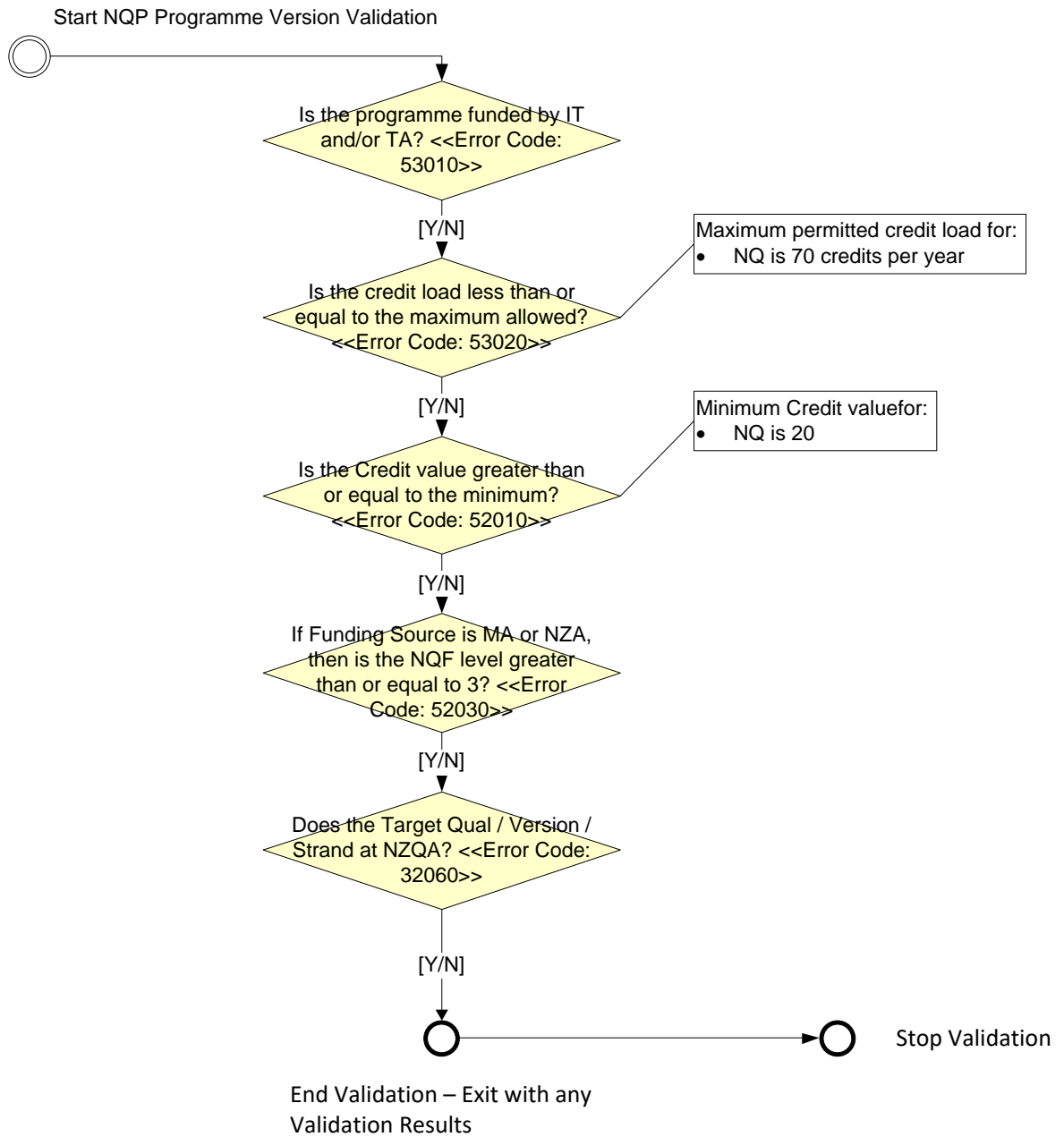

5.3.5 Complex modern apprenticeship (E8)

The structure for registering new versions of a complex modern apprenticeship is the same as that described in section 5.2.7.

The table below describes additional validations required to register a new version of a complex modern apprenticeship.

Element name	Cardinality	Data type	Description
Nothing additional			

5.3.5.1 Additional validation rules

In addition to the element specific validation rules listed in the section above please note the following:

1. When registering a new version of a complex MA or NZA, if there is only one sub-programme then there must be at least one additional unit.
2. Sub-programmes programme numbers must match those previously submitted for the old version for the complex MA or NZA, however the sub-programme version numbers may be different.

5.3.5.2 Validation flow diagram

Validate Complex MA or NZA Programme Version

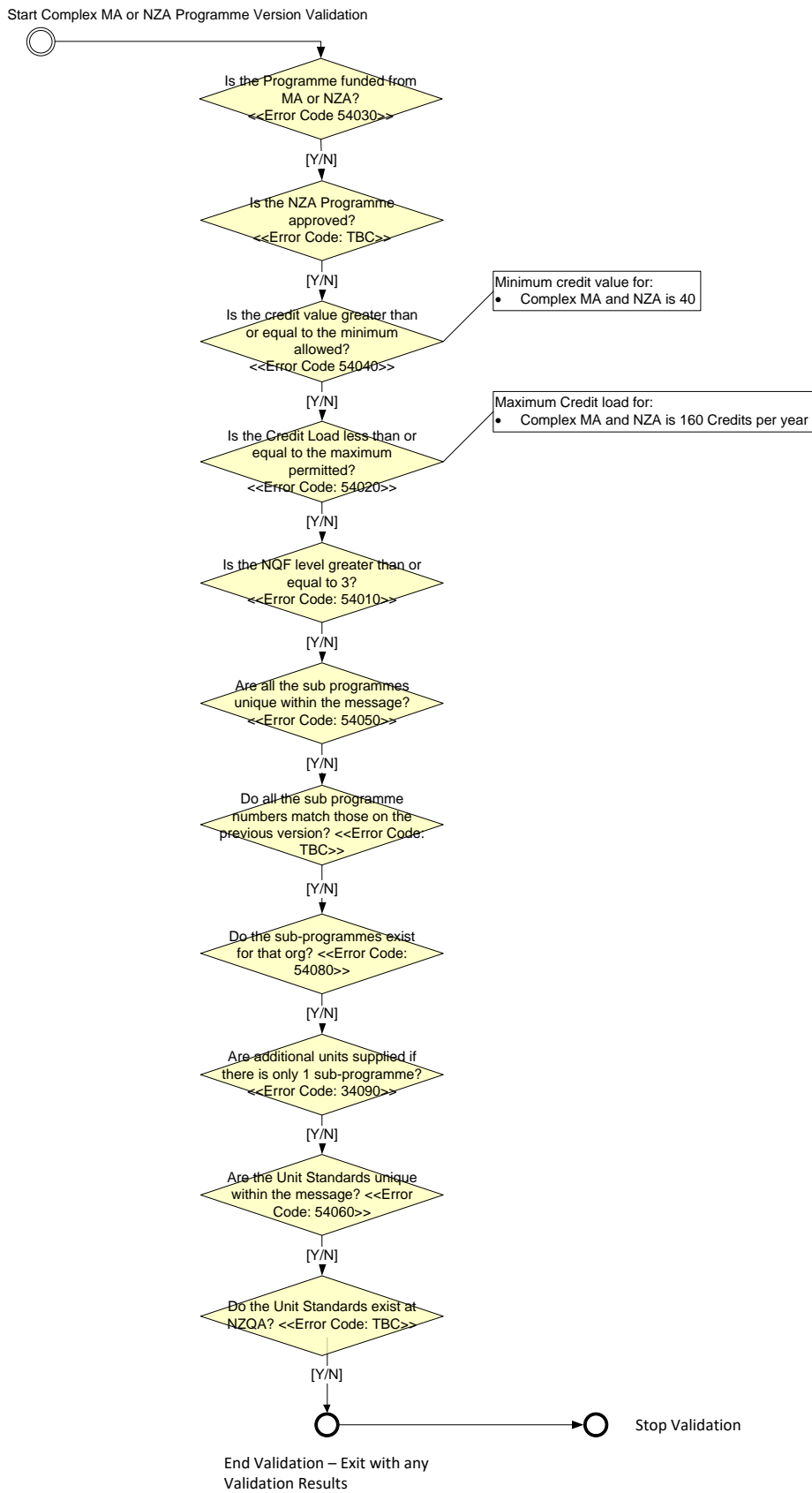

5.4 Update programme (E9)

At some point programme versions will need to be expired. When this is required a message will be sent giving the expiry date and this will be logged in the ITR database.

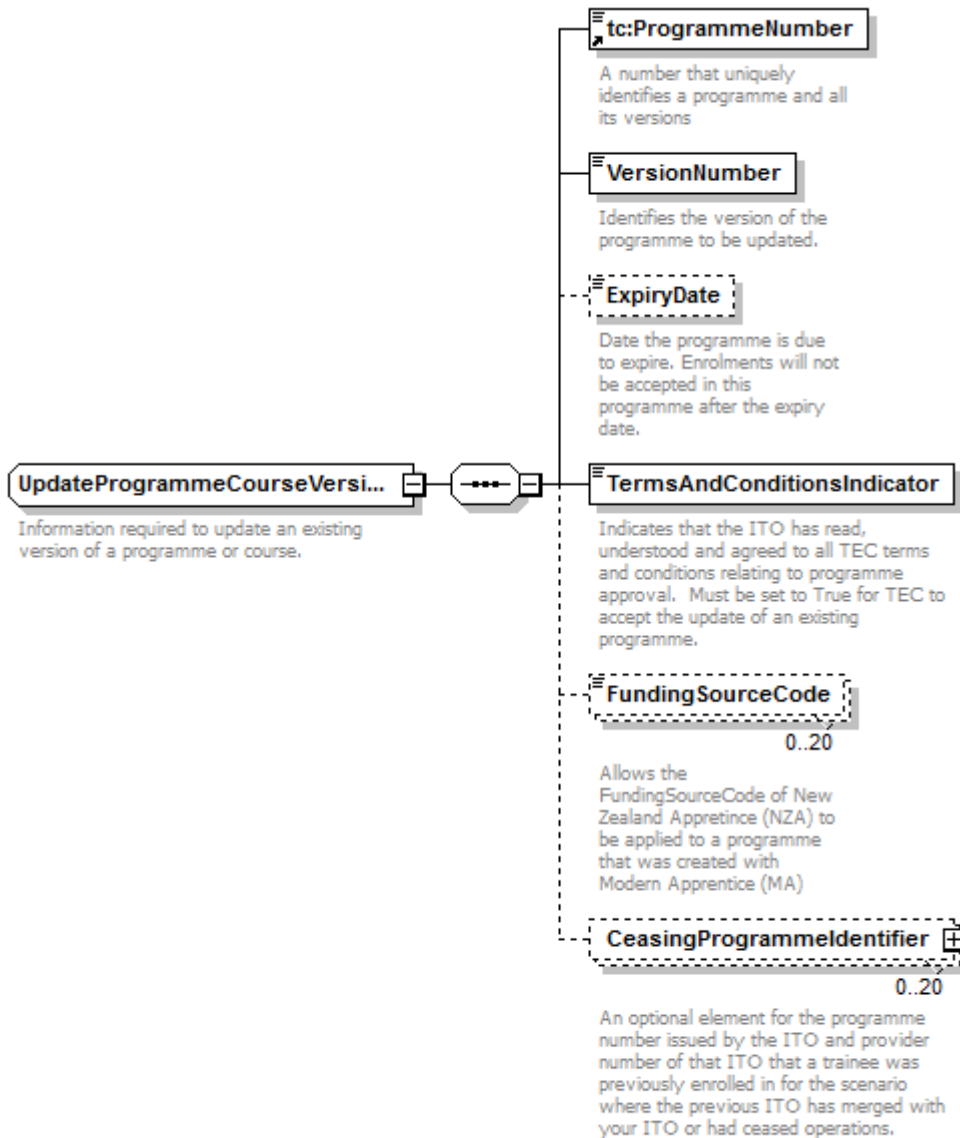

Generated by XMLSpy

www.altova.com

Element name	Cardinality	Data type	Description
ProgrammeNumber	1	Number Type	<p>A TEC issued number that identifies an approved training programme.</p> <p>Note: This will be returned as an object identifier following the successful processing of a Create Programme Course message.</p> <p>Validation:</p> <p>1 Must match active programme for the ITO.</p>

Element name	Cardinality	Data type	Description
VersionNumber	1	Number Type	A TEC issued number that identifies the version of the approved training programme. Note: This will be returned as an object identifier following the successful processing of a Create Programme Course or Create Programme Course Version message.
ExpiryDate	0..1	DateType	See section 5.2.3 for details This may be blank to remove an expiry date.
TermsAndConditionIndicator	1	Indicator Type	See section 2.2 for details.
FundingSourceCode	0..20	CodeType	See section 5.2.3 for details Additional Validation Funding Source Codes supplied must be the same as the Funding Source Codes stored on the Programme Course Version.
CeasingProgrammeIdentifier	0..20	Complex	See section 4.6 for details Additional Validation: The supplied EDUMIS for both ITOs must exist and be linked The Programme Local Identifier must exist and identify a Programme at the ceasing Organisation (identified by the EDUMIS supplied) The EDUMIS and Programme ID supplied must not have been linked to by any other ITO or from a different programme at the same ITO. Have all previously supplied ceasing programme identifiers been supplied if there are existing enrolments for that programme version?

5.4.1 Additional validation rules

In addition to the element specific validation rules listed in the section above please note the following:

1. For all programme types: Find existing programme course version in the db, for this organisation - where programme number and version number matches the details supplied in the message. If this doesn't exist, then don't validate any further.
2. For all programme types: Expired programmes cannot be updated as we do not want to affect historical reports. Check that the existing programme course version in the db has not expired (existing expiry date must be blank or existing expiry date > today).

3. For all programme types: If specified, the expiry date in the message must be > start date of existing programme course version.

5.4.2 Validation flow diagram

Validate Basic Programme Update

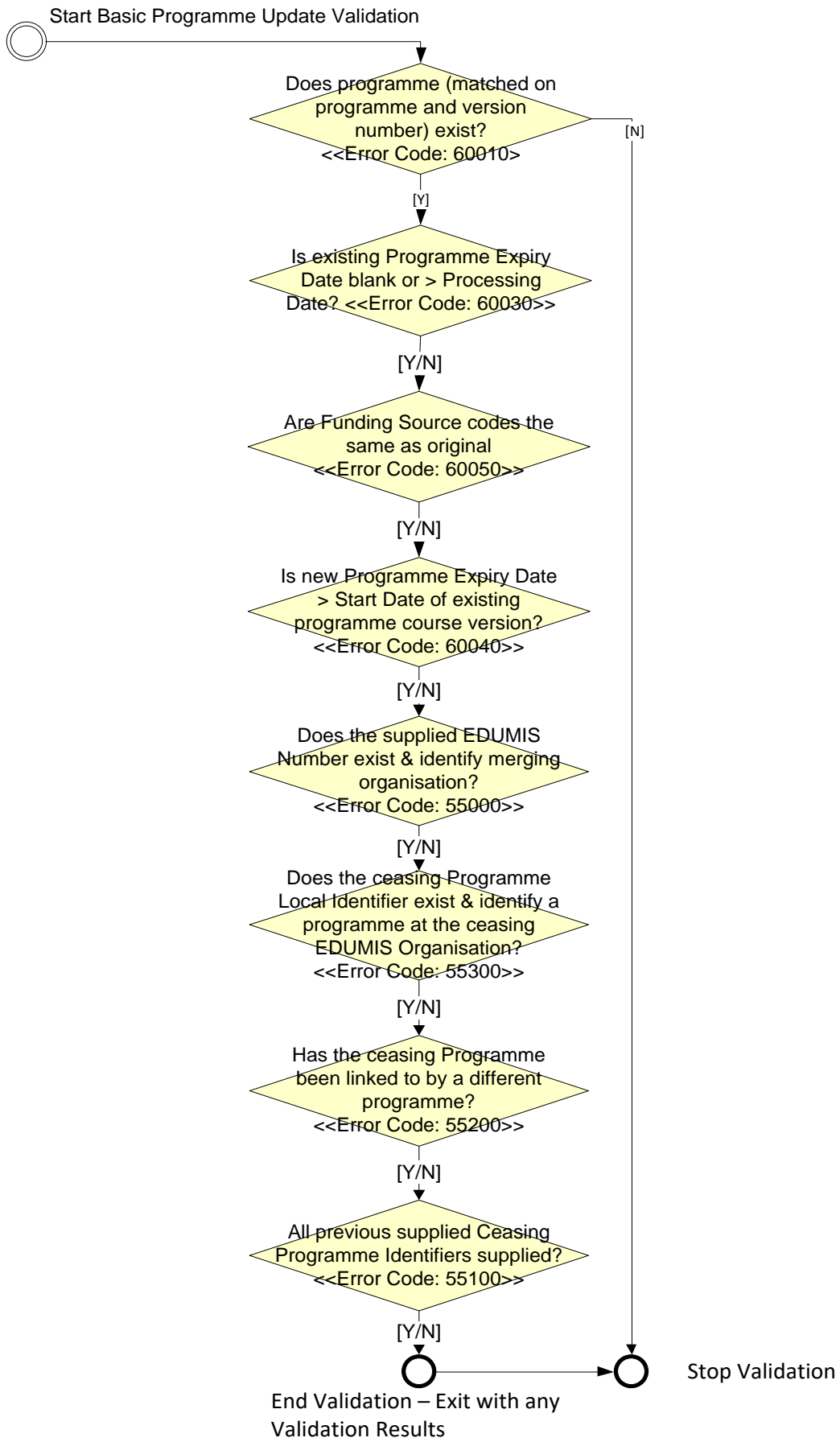

5.5 Create training agreement

To claim funding from the TEC, a trainee must have a valid training agreement which is a formal agreement between the trainee, employer and ITO (Rule ITO004). In the past, the TEC has captured details about a training agreement along with details about the programme(s) that the trainee is enrolling on. ITR has adopted a new approach where ITOs have to supply information about a Training Agreement and Enrolment as separate entities, although often within the same message.

The difference between a Training Agreement and Enrolment are:

1. Training Agreement records information about the agreement between the trainee, employer and ITO; and
2. Enrolment records information about the programme(s) the trainee is enrolled on within the scope of the Training Agreement.

The basic structure of the CreateTrainingAgreement message is shown below:

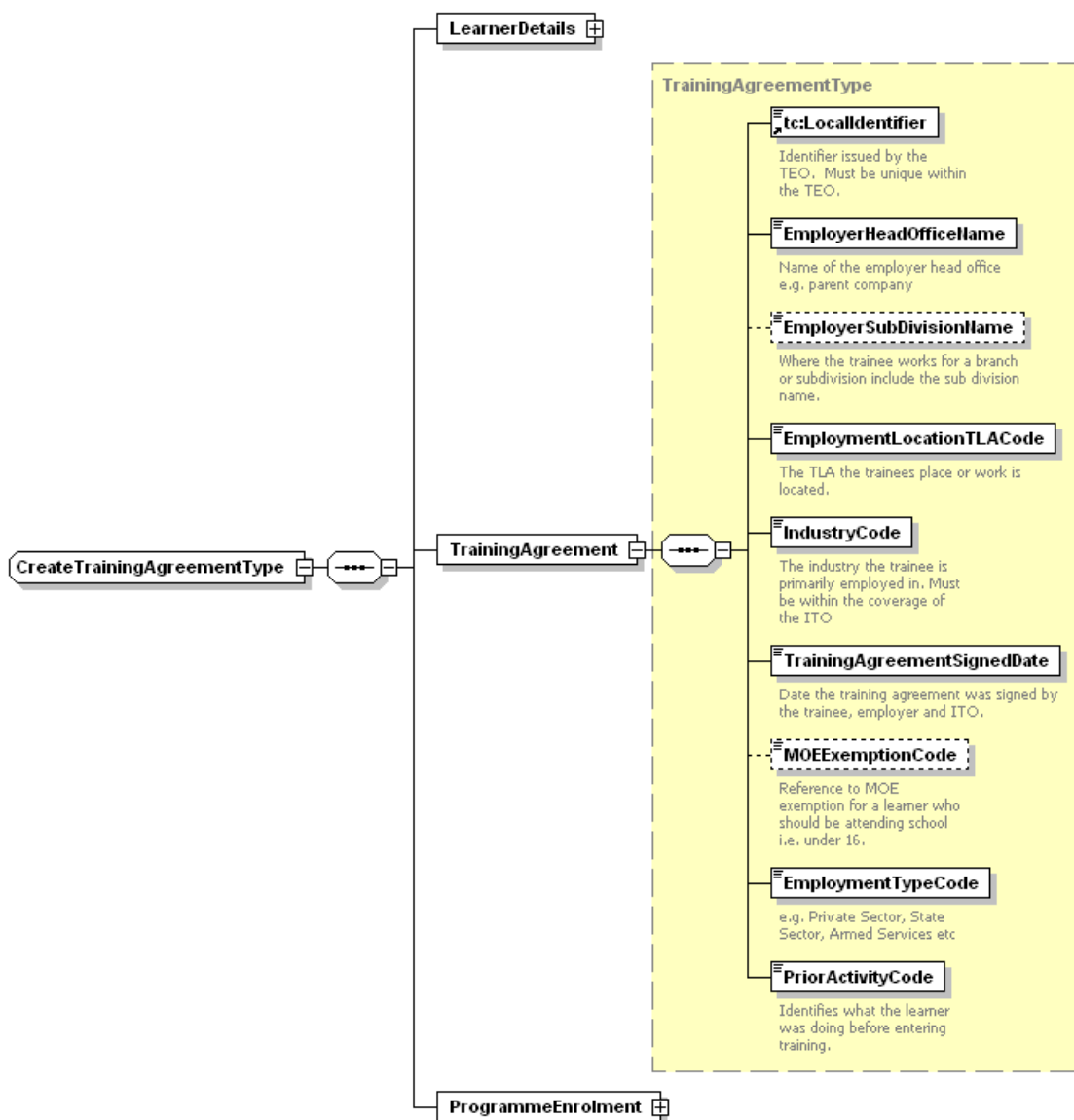

Generated with XMLSpy Schema Editor www.altova.com

Trigger: The CreateTrainingAgreement message will occur when a TMS user enters a new training agreement plus enrolment for a trainee. This may be for a trainee who is already known to the ITO or a completely new trainee.

The elements required are described in more detail in the table below:

Element name	Cardinality	Data type	Description
LearnerDetails	1	Complex	Common learner information supplied with all messages. See section 4.2 for details.
LocalIdentifier	1	Identifier Type	An identifier issued by the ITO that uniquely identifies the Training Agreement to the ITO. This value must be unique to the ITO as it will be used as a reference should the ITO need to update the Training Agreement. Validation: 1 Must be unique for the ITO.
EmployerHead OfficeName	1	NameType	The name of the employer. Must be the legal name of the organisation that is employing the trainee. Where the employer has multiple sites this must be the name the parent or head office is known by.
EmployerSub DivisionName	0..1	NameType	The name of the subdivision a trainee is working for where the employer has multiple sites.
EmploymentLocation TLACode	1	CodeType	A code defined by Statistics New Zealand that identifies the Territorial Local Authority (recently, Territorial Authority) Region the trainees' place of employment is located in. Validation: 1 Must be a code from the 2006 Territorial Authority .
IndustryCode	1	CodeType	A code defined by Statistics New Zealand that identifies the primary industry the trainees using that programme are working in. Validation: 1 Must match a code from level 4 of the industry classification.
TrainingAgreement SignedDate	1	DateType	Date the Training Agreement was signed by the trainee, employer and ITO. Validation: 1 TrainingAgreementSignedDate <= Today. 2 The learner must be over 16-years old at the date the training agreement is signed unless the MOEExemptionCode is supplied (see below). 3 TrainingAgreementSignedDate > the learner's BirthDate

Element name	Cardinality	Data type	Description												
			4 TrainingAgreementSignedDate >= Today minus maximum backdate months (this is a parameter that will be set to 120 to start with)												
MOEExemptionCode	0..1	xs:string	<p>If a trainee is under 16, they are normally required to be enrolled in secondary education. This element captures a reference number provided by the MOE that identifies an exemption they have granted to a trainee to not be in secondary education.</p> <p>Validation:</p> <p>1 Must be supplied if trainee is less than 16-years old at the date the training agreement is signed.</p>												
EmploymentType Code	1	CodeType	<p>A code that identifies the nature of the trainees' employment relationship with their employer.</p> <p>Validation:</p> <p>1 Must match one of the values below taken from the legacy system ILU:</p> <table border="1"> <thead> <tr> <th>Value</th> <th>Description</th> </tr> </thead> <tbody> <tr> <td>E</td> <td>Employee</td> </tr> <tr> <td>SS</td> <td>State Sector</td> </tr> <tr> <td>V</td> <td>Volunteer</td> </tr> <tr> <td>SE</td> <td>Self Employed</td> </tr> </tbody> </table>	Value	Description	E	Employee	SS	State Sector	V	Volunteer	SE	Self Employed		
Value	Description														
E	Employee														
SS	State Sector														
V	Volunteer														
SE	Self Employed														
PriorActivityCode	1	codeType	<p>A code that identifies what the learner was doing immediately prior to entering training.</p> <p>Validation:</p> <p>1 Must be one of the following values which match the SDR manual⁷:</p> <table border="1"> <thead> <tr> <th>Value</th> <th>Description</th> </tr> </thead> <tbody> <tr> <td>01</td> <td>Secondary School Student</td> </tr> <tr> <td>02</td> <td>Non-employed or Beneficiary</td> </tr> <tr> <td>03</td> <td>Wage or Salary Worker</td> </tr> <tr> <td>04</td> <td>Self-Employed</td> </tr> <tr> <td>05</td> <td>University Student</td> </tr> </tbody> </table>	Value	Description	01	Secondary School Student	02	Non-employed or Beneficiary	03	Wage or Salary Worker	04	Self-Employed	05	University Student
Value	Description														
01	Secondary School Student														
02	Non-employed or Beneficiary														
03	Wage or Salary Worker														
04	Self-Employed														
05	University Student														

⁷ The codes defined in the SDR manual are being used to ensure consistency between the different data collection mechanisms across the tertiary sector.

Element name	Cardinality	Data type	Description												
			<table border="1"> <tr> <td>06</td> <td>Polytechnic Student</td> </tr> <tr> <td>07</td> <td>College of Education Student</td> </tr> <tr> <td>08</td> <td>House-person or Retired</td> </tr> <tr> <td>09</td> <td>Overseas</td> </tr> <tr> <td>11</td> <td>Private Training Student</td> </tr> <tr> <td>12</td> <td>Wananga Student</td> </tr> </table>	06	Polytechnic Student	07	College of Education Student	08	House-person or Retired	09	Overseas	11	Private Training Student	12	Wananga Student
06	Polytechnic Student														
07	College of Education Student														
08	House-person or Retired														
09	Overseas														
11	Private Training Student														
12	Wananga Student														
Programme Enrolment	1	Complex	Information about the industry training programme or modern apprenticeship programme the trainee is enrolled on.												
SimpleEnrolment	1..10	Complex	Enrolment in an LCP, Supplementary Credit Programme (SCP) or National Qualification programme that does not contain subcomponents. See section 5.5.4 for details.												
Complex Modern Apprenticeship	1	Complex	<p>An enrolment on a modern apprenticeship programme. Complex programmes will consist of approved industry training or trade academy programmes and additional unit standards when necessary to provide a balanced MA programme. See section 5.5.7 for details.</p> <p>Validation:</p> <p>1 Trainee may not simultaneously enrol in multiple modern apprenticeships or IT programmes.</p>												

5.5.1 Validation flow diagram

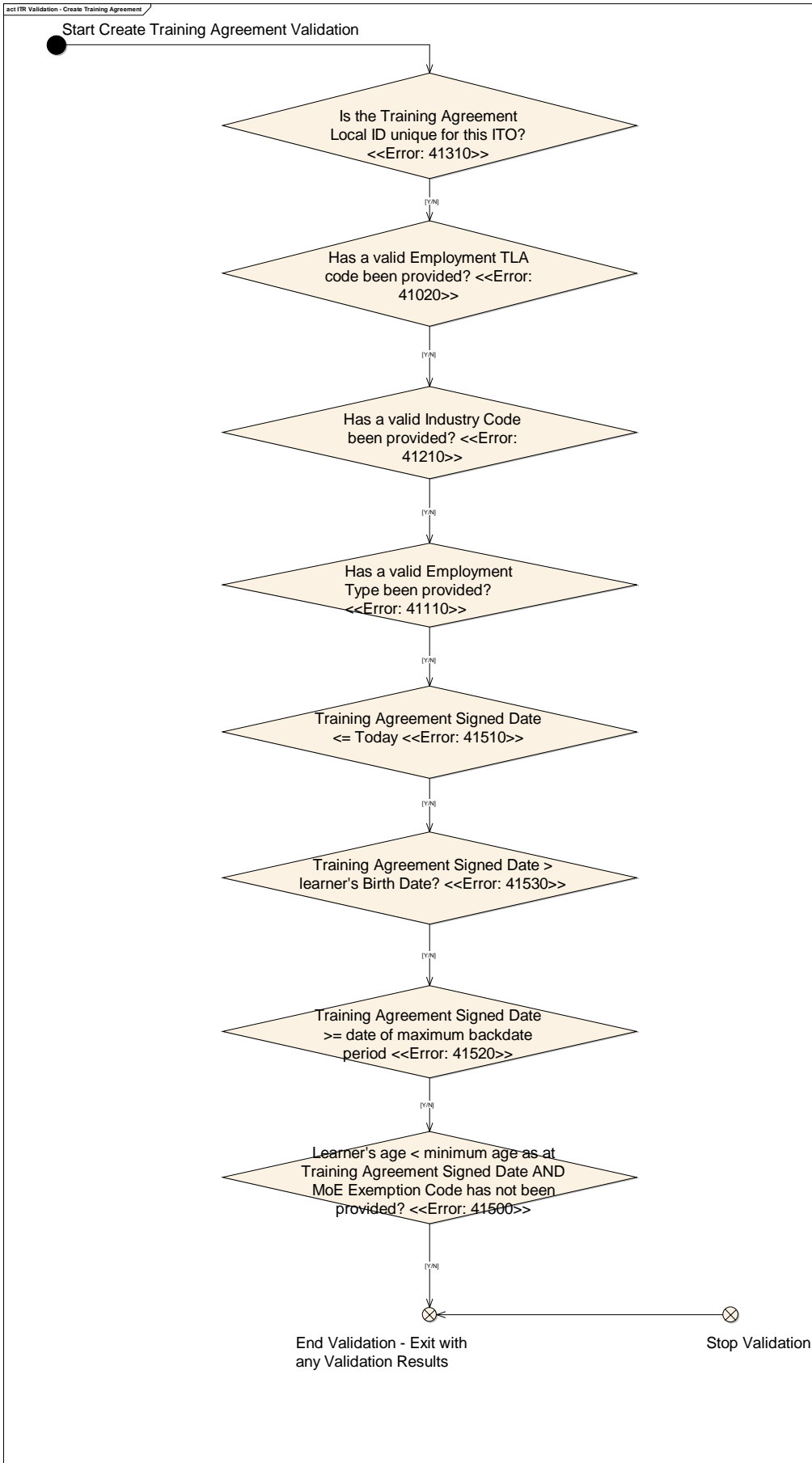

5.5.2 Training agreement and enrolment statuses

The diagram on the next page shows the relationship of the statuses on the training agreement and enrolment. Details of each status are provided in the tables following the diagram

For this diagram, where it reads MA, NZA is also Applicable

stm Training Agreement & Enrolment State Transition Diagram

Name: Training Agreement & Enrolment State Transition Diagram
 Package: Leamer Event
 Version: 1.0
 Author: Paul Femyhough

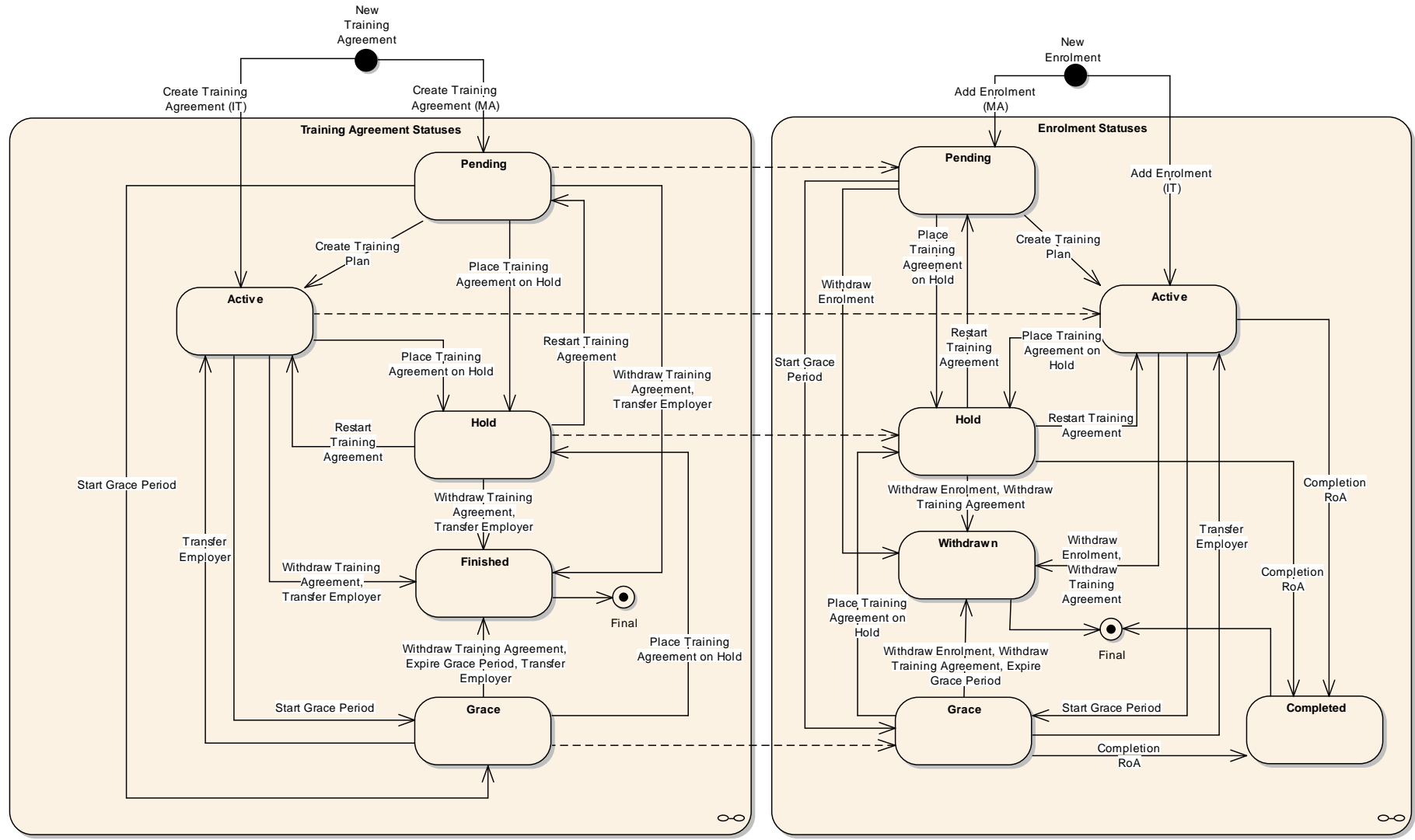

The list below indicates the statuses available on the Training Agreement:

Value	Description	Details
PENDING	Pending	<p>A Training Agreement is set to Pending if it has been created for an MA or NZA. The TA remains with the Pending status until one of the following scenarios:</p> <ul style="list-style-type: none"> • An associated Create Training Plan message has been received from the ITO – the Training Agreement will then move to a status of “Active”. • An associated Place Training Agreement on Hold message has been received from the ITO – the Training Agreement will then move to a status of “Hold”. • An associated Start Grace Period message has been received from the ITO – the Training Agreement will then move to a status of “Grace”. • An associated Withdraw from Training Agreement message has been received from the ITO – the Training Agreement will then move to a status of “Finished”. <p>When a Training Agreement is set to “Pending”, all associated Enrolments are set to “Pending”.</p> <p>Note: If an associated Transfer Employer message has been received from the ITO – the current Training Agreement will then move to a status of “Finished” and the new Training Agreement will have a status of “Pending”.</p>
ACTIVE	Active	<p>A Training Agreement is set to Active in the following scenarios:</p> <ul style="list-style-type: none"> • The Training Agreement has been created for an IT or TA enrolment. • The Training Plan has been created for an MA or NZA. enrolment. • The Training Agreement has been restarted after being on Hold and if an MA or NZA. enrolment there is a current Training Plan. <p>When a Training Agreement is set to “Active”, all associated Enrolments that don’t have a status of “Withdrawn” or “Complete” are set to “Active”.</p> <p>Please note if during a Grace period the learner has found another employer, the ITO will need to use the Transfer Employer message to create a new Training Agreement with the new employer’s details. Successful processing of this message will set the status of the Training Agreement with the previous employer to “Finished” and create a new Training Agreement. The new Training Agreement will have a status of “Active” unless it is for an MA or NZA enrolment and a Training Plan does not exist for it. In the latter scenario, the status of the new Training Agreement will be set to “Pending”.</p>

Value	Description	Details
HOLD	Hold	<p>A Training Agreement can be placed on Hold from the “Active”, “Pending” and “Grace” statuses and is triggered by the Place Training Agreement on Hold message.</p> <p>When a Training Agreement is set to “Hold”, all associated Enrolments that don’t have a status of “Withdrawn” or “Completed” are set to “Hold”.</p> <p>Please note if during the Hold period the learner has found another employer, the ITO will need to use the Transfer Employer message to create a new Training Agreement with the new employer’s details. Successful processing of this message will set the status of the Training Agreement with the previous employer to “Finished” and create a new Training Agreement. The new Training Agreement will have a status of “Active” unless it is for an MA enrolment and a Training Plan does not exist for it. In the latter scenario, the status of the new Training Agreement will be set to “Pending”.</p>
GRACE	Grace	<p>A Training Agreement can be placed in “Grace” from the “Active” and “Pending” statuses and is triggered by the Start Grace Period message.</p> <p>Please note if during the Grace period the learner has found another employer, the ITO will need to use the Transfer Employer message to create a new Training Agreement with the new employer’s details. Successful processing of this message will set the status of the Training Agreement with the previous employer to “Finished” and create a new Training Agreement. The new Training Agreement will have a status of “Active” unless it is for an MA enrolment and a Training Plan does not exist for it. In the latter scenario, the status of the new Training Agreement will be set to “Pending”.</p>
FINISHED	Finished	<p>A Training Agreement is set to “Finished” in the following scenarios:</p> <ul style="list-style-type: none"> • The Training Agreement was in Grace and the grace period has expired. This expiration will be achieved by an overnight batch process. • The Training Agreement is withdrawn. • A Transfer Employer message has been successfully processed which sets the status of the Training Agreement with the previous employer to “Finished”.

The list below indicates the statuses available on the Enrolment:

Value	Description	Details
PENDING	Pending	<p>An Enrolment is set to “Pending” if the associated Training Agreement has a status of “Pending” i.e. it has been created for an MA or NZA. The Enrolment remains with the “Pending” status until the associated Training Agreement moves to one of the following statuses (which the Enrolment status will match):</p> <ul style="list-style-type: none"> • Active • Hold • Grace • Withdrawn
ACTIVE	Active	An Enrolment is set to “Active” to match the associated Training Agreement’s “Active” status.
HOLD	Hold	An Enrolment is set to “Hold” to match the associated Training Agreement’s “Hold” status.
GRACE	Grace	An Enrolment is set to “Grace” to match the associated Training Agreement’s “Grace” status.
COMPLETED	Completed	<p>An Enrolment is set to “Completed” in the following scenarios:</p> <ul style="list-style-type: none"> • The (nightly) NZQA RoA check indicates that the qualification has been achieved by the learner AND the ITR has checked that all additional units (if any) have been achieved.
WITHDRAWN	Withdrawn	<p>An enrolment is set to “Withdrawn” in the following scenarios:</p> <ul style="list-style-type: none"> • The Training Agreement was in “Grace” and the grace period has expired. This expiration will be achieved by an overnight batch process. This process will set any associated enrolments not previously set to “Withdrawn” or “Completed” to “Withdrawn”. • The Training Agreement is withdrawn and the enrolment was not previously set to “Withdrawn” or “Completed”. • A Withdraw Enrolment message is received. • Transferring from MA to NZA funded programmes • If the link status of the ITOs is merging and the previous ITO is in the merged ceasing state

All these statuses will be triggered either as a result of a message received from the ITO or as part of the NZQA RoA check or Grace Period expiry check. Outside of these scenarios, ITR will not change these statuses.

5.5.3 Active state in relation to enrolments

At several points during the descriptions of enrolments in this section, there will be reference to the state 'Active' e.g. an 'Active' programme. For enrolment comparisons, a programme is deemed as active when:

- The programme belongs to the ITO. If not, validation stops at this point.
- The programme is not declined i.e. Approved
- The programme expiry date has not passed

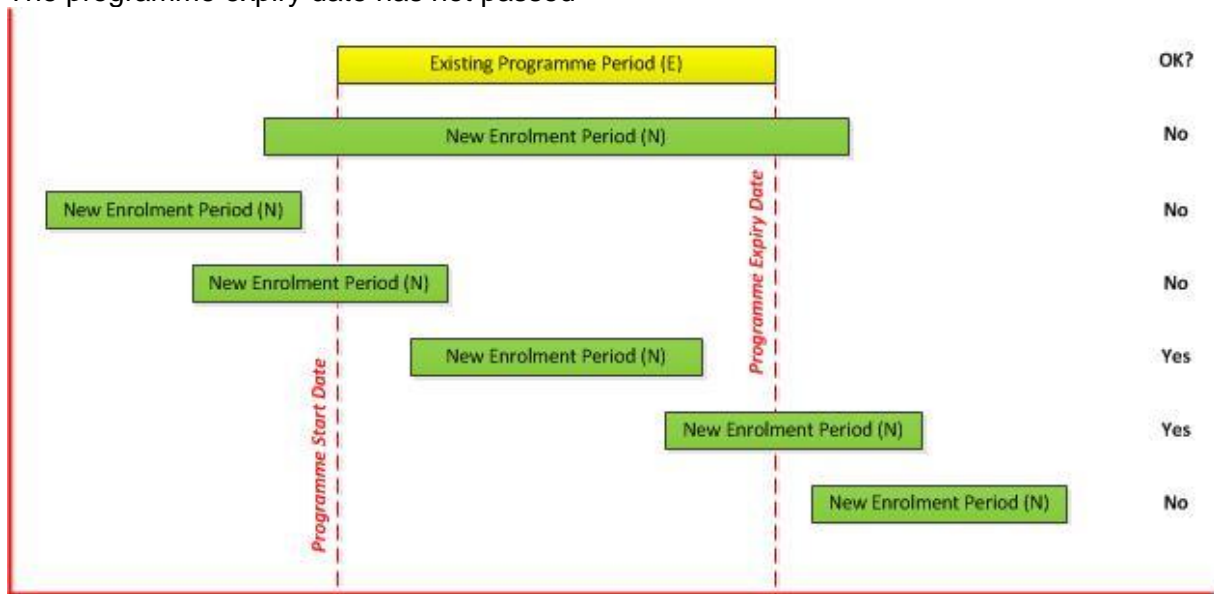

- Enrolment starts within the period of the programme.

In order to check this, use the following formula. It is possible for the existing programme (E) to have no expiry date. Where that is the case then this is set to MAX(date) and the following formula works using this MAX(date). There is no expiry for an enrolment until it is completed/withdrawn.

$(N) \text{ Participation Start Date} \geq (E) \text{ Start Date AND } (N) \text{ Participation Start Date} < (E) \text{ End Date}$

NOTE: this is different to the situation where you are registering a programme (see Section 5.2.1 below).

5.5.4 Simple enrolment (E10)

The purpose of this portion of the CreateTrainingAgreement message is to allow an ITO to enrol a trainee or modern apprentice on an industry training programme. This is the simplest form of enrolment, as it does not contain any form of sub-enrolment. Please refer to section 5.5.7 for a definition of Complex Modern Apprenticeship Programmes enrolments.

A simple industry training enrolment records details about the training programme the trainee is enrolled on, credits and duration etc.

A trainee may be simultaneously enrolled in multiple programmes as an Industry Trainee or as a Trade Academy learner, but cannot be enrolled in multiple Modern Apprenticeships or New Zealand Apprenticeships.

A “Current” enrolment is defined as an enrolment with a status is “Active”, “Pending”, “Hold” or “Grace”.

The diagram below describes the elements of a Simple Industry Training Enrolment:

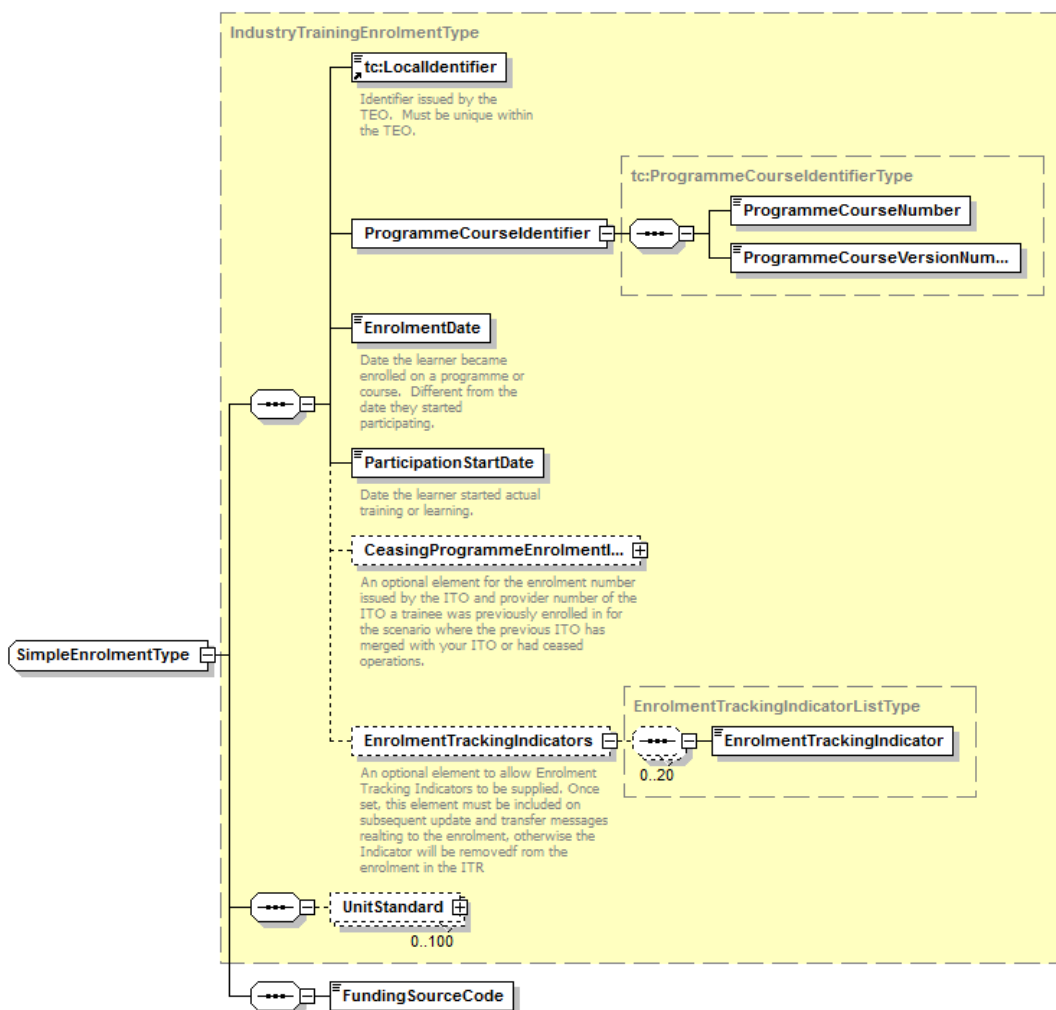

Generated with XMLSpy Schema Editor www.altova.com

Notes:

- **CREDITS**: ITOs do not need to supply the number of credits to be assessed within the enrolment. This will be calculated from the unit standards supplied
- **DURATION**: Will be calculated by the TEC.

The table below describes each element in more detail:

Element name	Cardinality	Data type	Description
LocalIdentifier	1	Identifier Type	<p>A string that uniquely identifies the enrolment in a programme. Should be different from the training agreement LocalIdentifier.</p> <p>Will be used by the ITO to identify the enrolment in future messages (e.g. updates).</p> <p>Validation:</p> <ol style="list-style-type: none"> 1 Must not be used to identify any other enrolment supplied by the ITO, regardless of enrolment status. Please note, this does not include DELETED enrolments
ProgrammeCourse Identifier	1	Complex	<p>Identifies a Programme or Course. The combination of TEC ProgrammeCourseNumber and VersionNumber uniquely identify a version of a programme. See section 4.3 for details.</p> <p>Validation:</p> <ol style="list-style-type: none"> 1 The programme must exist and the ITO must be authorised to deliver the programme. 2 The programme version must be Active as at the enrolment ParticipationStartDate (see Section 5.5.3 which describes the definition of “active”) i.e. <ul style="list-style-type: none"> • approved • not be expired i.e. ParticipationStartDate < programme ExpiryDate • ParticipationStartDate >= programme StartDate. 3 If a learner has enrolled in a programme once they will not be able to enrol in that programme (any version) again at a later date unless the status of the first enrolment is “Withdrawn” or DELETED <p>A learner cannot be enrolled in the same programme simultaneously. For example the EnrolmentDate of an enrolment cannot be less than the withdrawal date of a previous enrolment</p>

Element name	Cardinality	Data type	Description
			<p>in the same programme i.e. same programme number, any version.</p> <p>If the status of the previous enrolment is Active, Pending, Hold, Grace or Complete, this will produce an error. However if the status is Withdrawn AND the EnrolmentDate (of new enrolment) > WithdrawalDate (of previous enrolment) this is ok.</p> <p>DELETED enrolments are excluded.</p> <p>4 The programme type must be valid for a simple enrolment i.e. "NQ", "LCP" or "SCP".</p>
EnrolmentDate	1	DateType	<p>The date the learner became enrolled on the programme or course. This may be different from the date that learner actually started training or learning.</p> <p>Validation:</p> <p>1 EnrolmentDate >= TrainingAgreementSignedDate</p>
ParticipationStart Date	1	DateType	<p>The date the learner actually started learning or training.</p> <p>Validation:</p> <p>1 ParticipationStartDate >= EnrolmentDate;</p> <p>2 For MA-funded enrolments cannot have ParticipationStartDate on or after 1st January 2014</p> <p>3 If the learner has a previous enrolment in an un-completed MA-funded enrolment (Simple or Complex), and the learner has withdrawn from this previous enrolment, then they are still eligible to register for MA-funded enrolment after 1st January 2014</p>
Unit Standard	0..100	Complex	<p>A list of unit standards that will be assessed during the enrolment.</p> <p>See section 4.5 for details.</p> <p>Validation:</p> <p>1 StandardNumber and StandardVersionNumber must be registered and active at NZQA</p> <p>2 StandardNumber and StandardVersionNumber must not match</p>

Element name	Cardinality	Data type	Description
			<p>a unit standard on the learner's Record of Achievement achieved before the ParticipationStartDate, unless the Standard also exists after the ParticipationStartDate, and it must be paid at NZQA;</p> <p>3 No Standard (Number and Version Number) may exist on any previous enrolments for this learner across any ITO, where the enrolment status is "Active", "Pending", "Hold", "Grace" or "Completed", unless the Standard (Number and Version Number) has been withdrawn from the learner's RoA;</p> <p>4 Across all enrolments in the Training Agreement message, check that the unit standards (unit standard number only, can be any version) are unique i.e. not duplicated;</p> <p>6 StandardNumber must exist for this programme. (LCP & SCP only)</p> <p>7 StandardNumber and StandardVersionNumber must not match an invalid unit standard on the learner's Record of Achievement.</p> <p>8 For SCP and LCP enrolments there must be at least one unit standard supplied</p>
FundingSourceCode	1	Code Type	<p>A code that identifies how the enrolment is funded.</p> <p>Validation:</p> <p>1 Must match one of the values listed in section 5.2.3;</p> <p>2 Where the value supplied = "MA" or "NZA" the learner cannot have any other "Active", "Pending", "Hold" or "Grace" MA or NZA enrolments at any ITO.</p> <p>3 The FundingSourceCode provided must be a valid value for the programme.</p> <p>4 Where the Funding Source Code is NZA the Programme Funding Source of NZA must be "Approved"</p> <p>5 Where the FundingSourceCode is NZA, the ParticipationStartDate cannot be less than 1st Jan 2014</p> <p>6. Where the FundingSourceCode is MA the Date the message is received by ITR must be less than 1st April 2014</p>

Element name	Cardinality	Data type	Description
CeasingProgramme EnrolmentIdentifier	0..1	Complex	<p>The enrolment details at the ceasing ITO</p> <p>See section 4.6 for details</p> <p>Additional Validation:</p> <p>The supplied enrolment ID must be valid</p> <p>The supplied enrolment must be for the same master NSN</p> <p>The programme version for this enrolment must be linked to the ceasing programme</p> <p>The participation start date of the new enrolment must be at least two days after the Participation Start Date of the ceasing enrolment</p> <p>The supplied enrolment must not be in a COMPLETED state</p> <p>The supplied enrolment must not be previously linked to by any other enrolment</p> <p>If the relationship between the linked ITO's is Transfer of Coverage; The supplied enrolment must be WITHDRAWN</p>
EnrolmentTrackingI ndicator	0..20	Complex	<p>See section 4.7 for details</p> <p>Supplied Enrolment Tracking Indicators must be valid</p>

5.5.5 Validation flow diagram

Validation of Simple Enrolments is made up of five parts:

1. Learner Details – Details about the learner are validated as described in section 4.2.
2. Training Agreement – Rules relating to valid Training Agreement as described in section 5.5.
3. ~~Modern Apprenticeships~~ – Rules relating to ~~Modern Apprenticeships~~ are evaluated as per the diagram below before checking other simple enrolment business rules.

Start Simple Enrolment – Apprenticeship Validation Checks

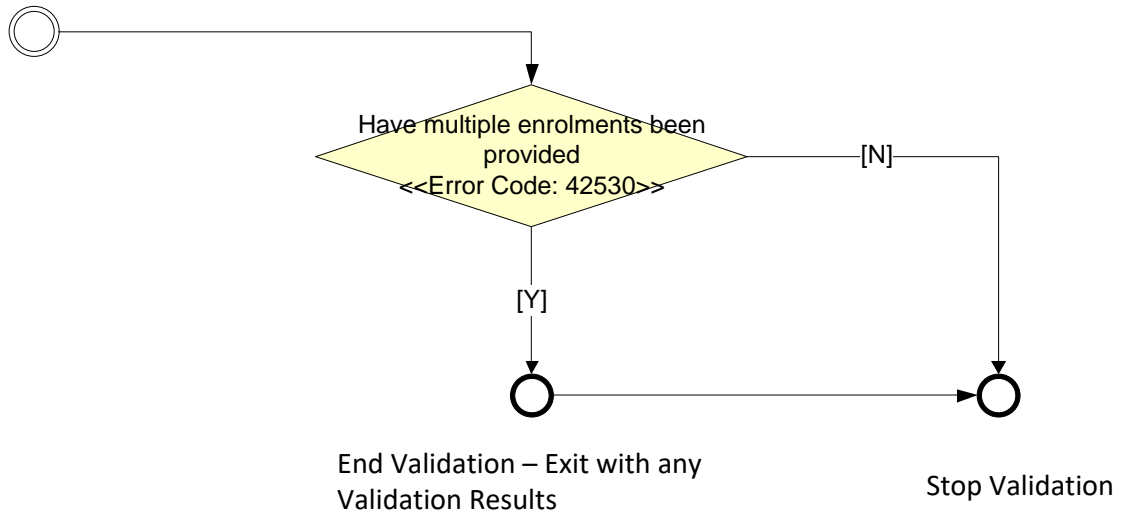

4. Simple enrolment collection validation – If the modern apprenticeship checks pass then ITR will validate the collection of simple enrolments provided in the message.

Is Simple Enrolment Collection Valid?

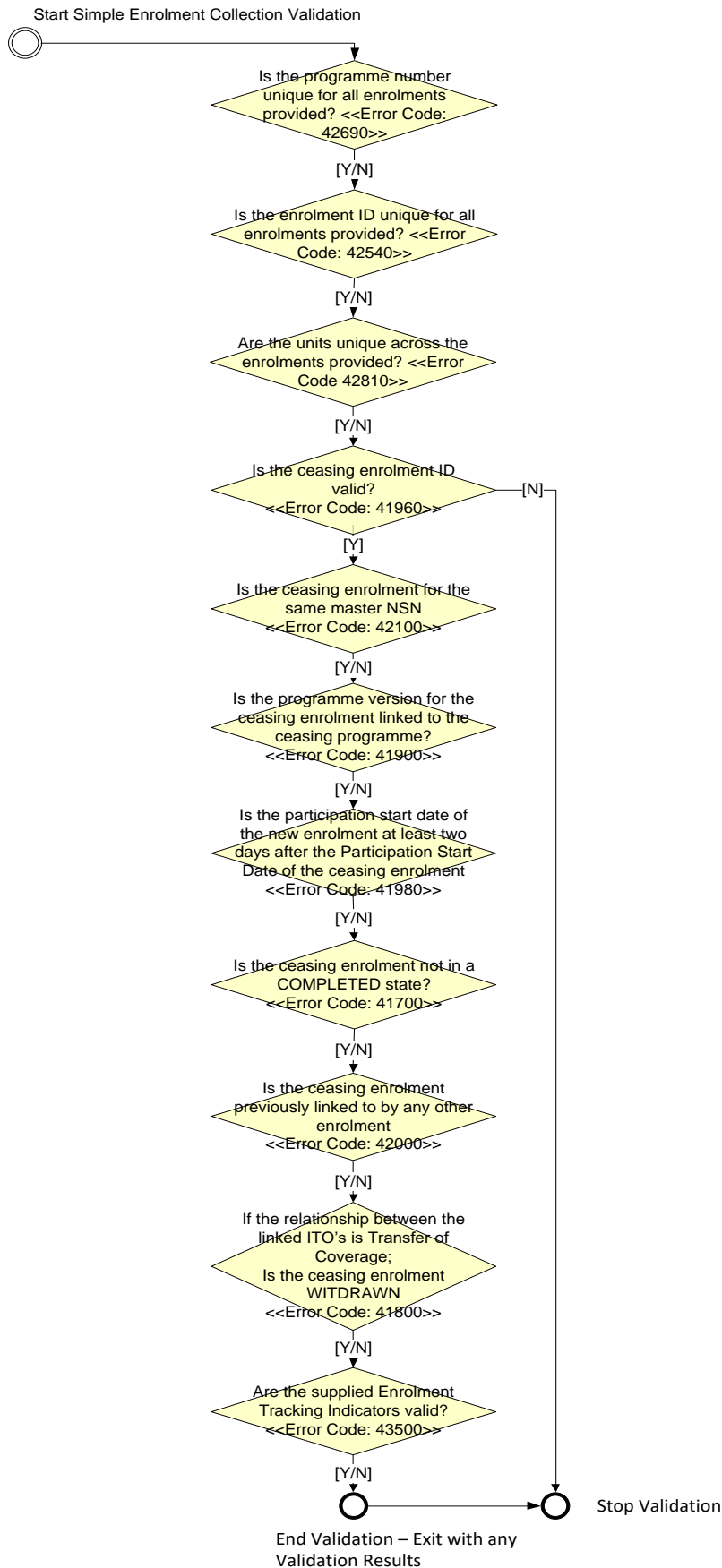

5. Simple enrolment validation – This series of checks are performed for each enrolment in the collection:

Validate Simple Enrolment

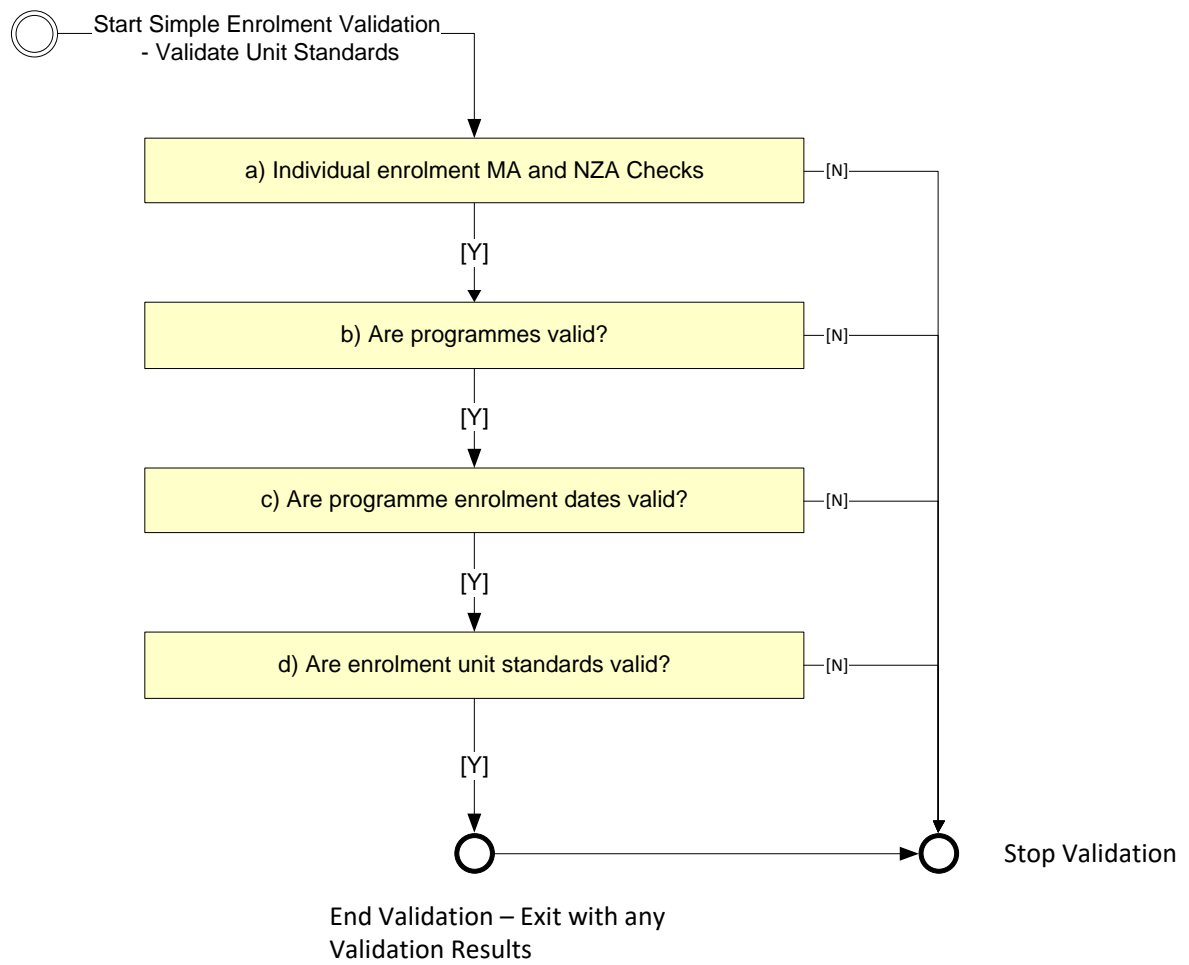

a. Individual enrolment MA or NZA checks

Individual enrolment MA checks activity diagram

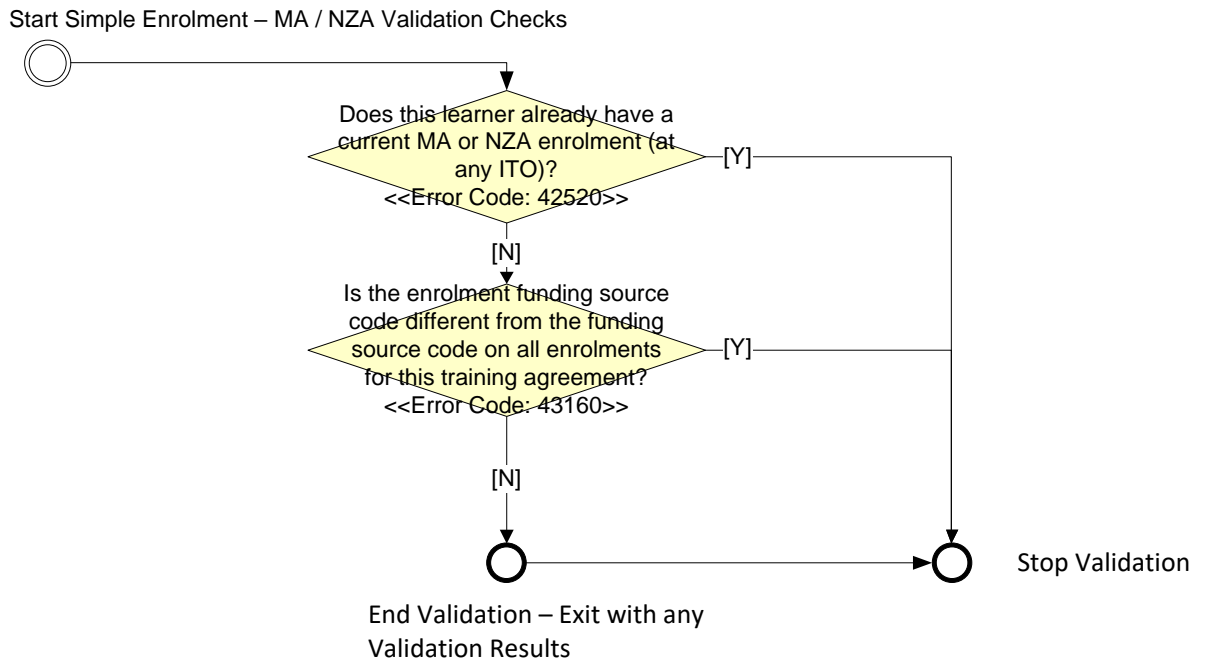

b. Are programmes valid?

Are Programmes Valid?

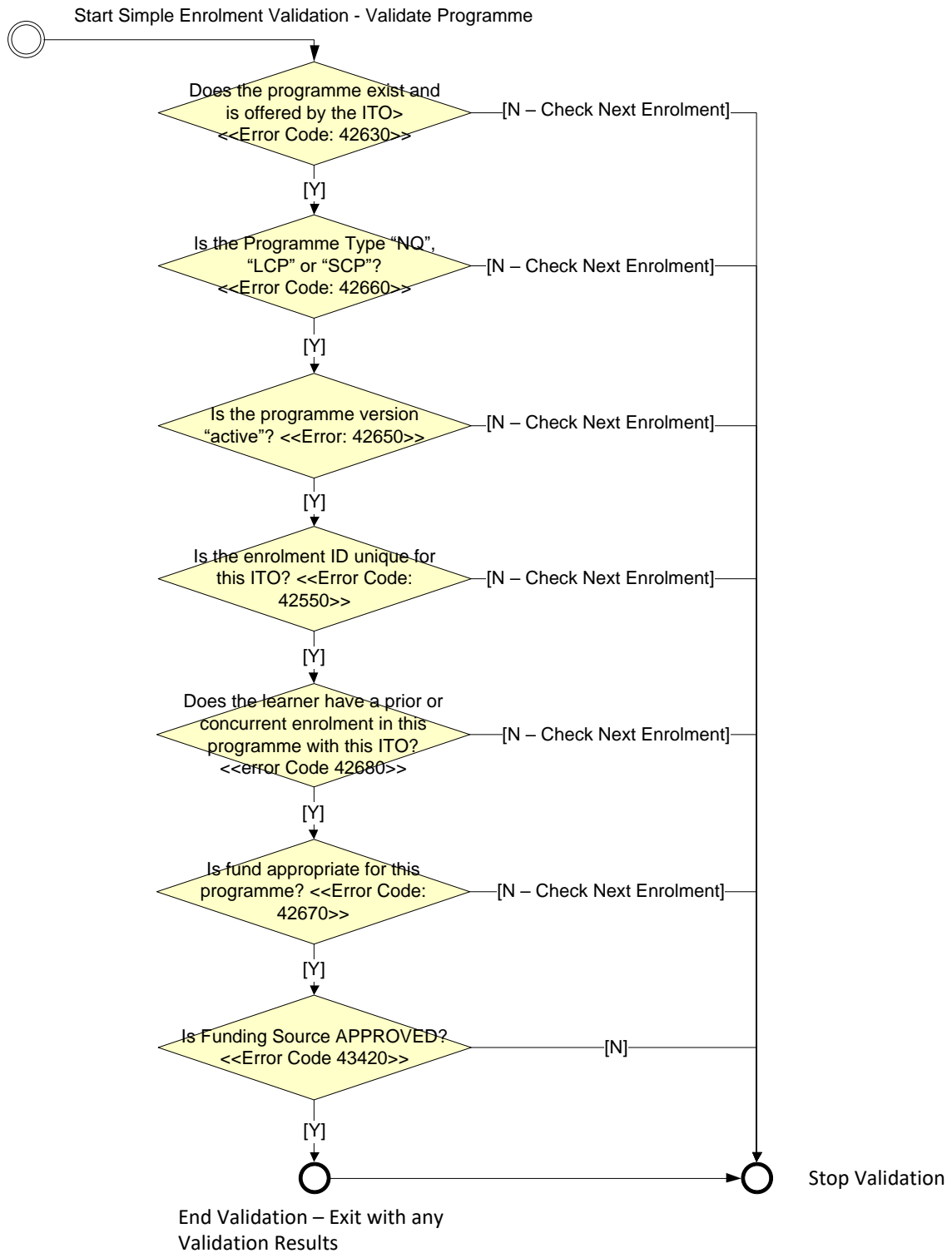

c. Are programme enrolment dates valid?

Are Programme Enrolment Dates Valid?

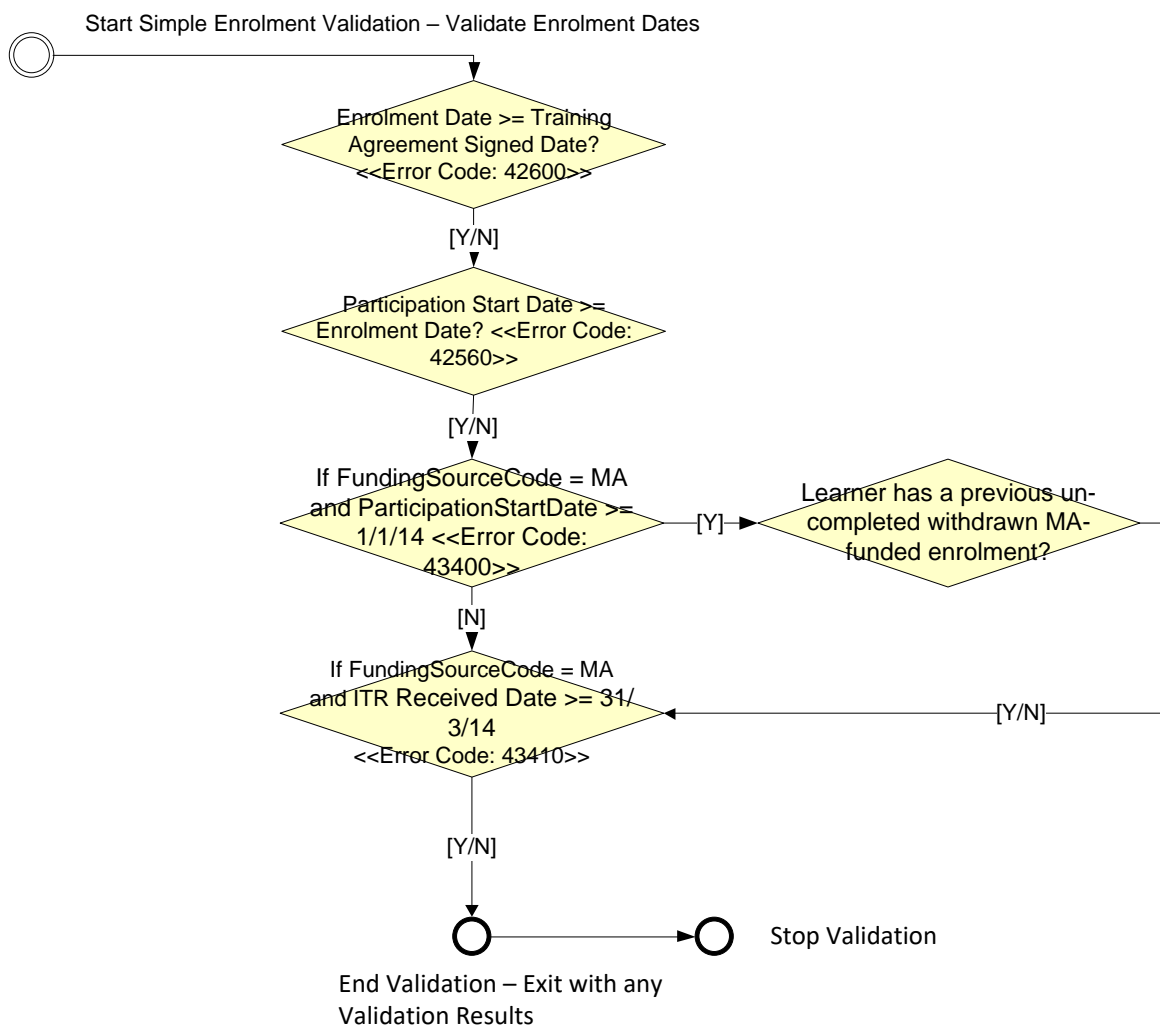

d. Are enrolment unit standards valid?

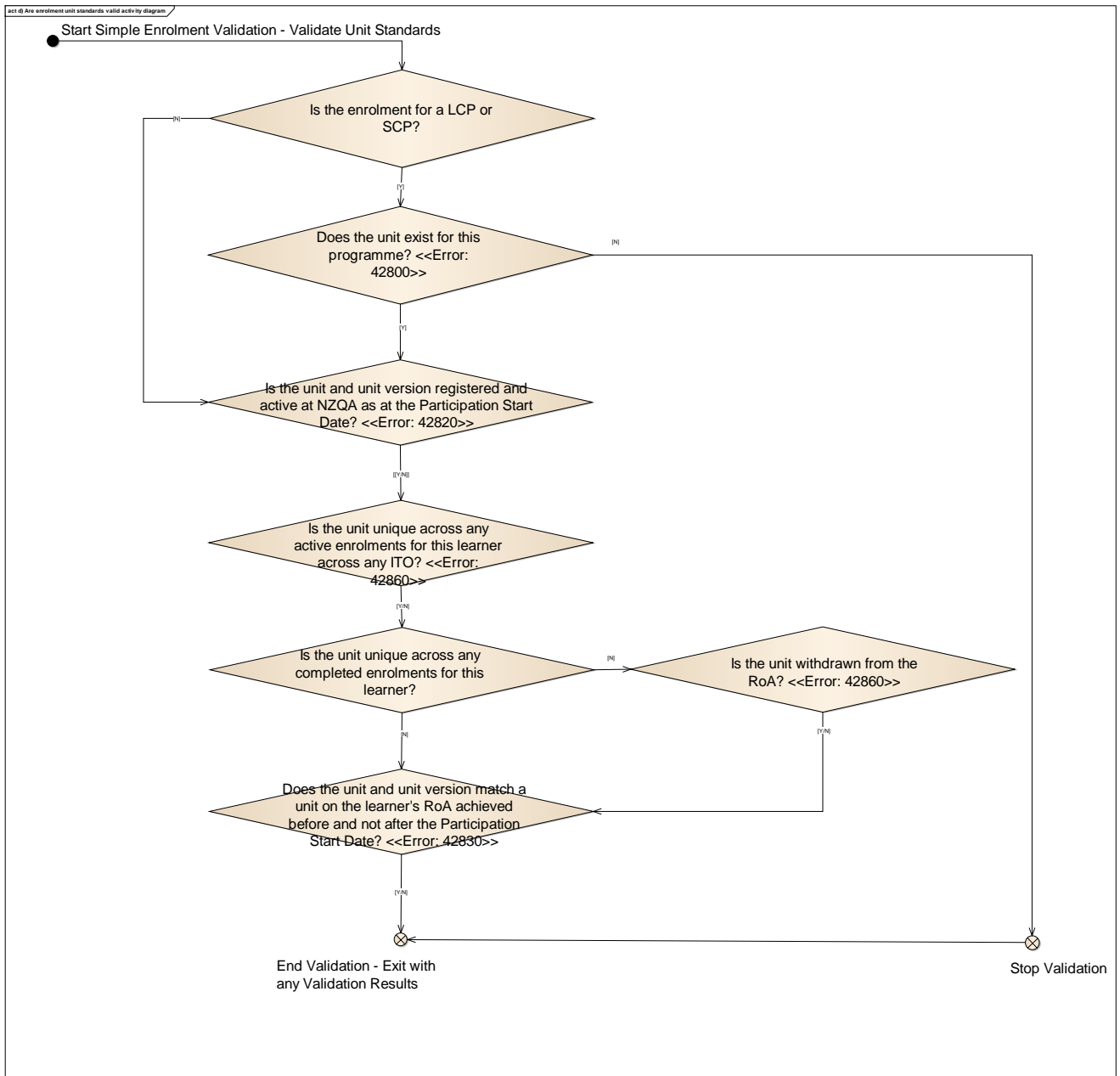

5.5.6 Business rules

The following business rules are applied if the Create Training Agreement and Create Simple Enrolment details are valid:

ID	Rule Description
1	Set the status of the training agreement to "Active" if the training agreement is for an IT or TA enrolment or set the status of the training agreement to "Pending" if the training agreement is for an MA or NZA enrolment.
2	Set the status of the enrolment(s) to "Active" if enrolment(s) is for IT or TA or set the status of the enrolment to "Pending" if the enrolment is for an MA or NZA enrolment.
3	Set the original training agreement signed date to the training agreement signed date. Note: The original training agreement signed date is required to be captured as the Transfer Employer message will create another Training Agreement for the enrolment, resulting in multiple training agreement signed dates. Refer to section 5.11 for further details. The original training agreement signed date (rather than the current training agreement signed date) will be used for Update and Add Enrolment validations.
4	ITR will create a history record to capture the changes – refer to Section.7.7.

5.5.7 Complex modern apprenticeship and New Zealand apprenticeship enrolment (E11)

Some Modern Apprenticeship programmes will consist of one or more approved industry training or trade academy programmes and additional unit standards when necessary to provide a balanced MA or NZA programme. Within the ITR, these programmes are known as “Complex Modern Apprenticeship Programmes”. Please refer to section 5.2.7 for more information on how this sort of programme is structured.

The purpose of the ComplexModernApprenticeshipEnrolmentType is to capture enrolment information when trainees enrol in a modern apprenticeship and each of its sub-enrolments.

The diagram below describes the elements that make up a Complex Modern Apprenticeship Enrolment:

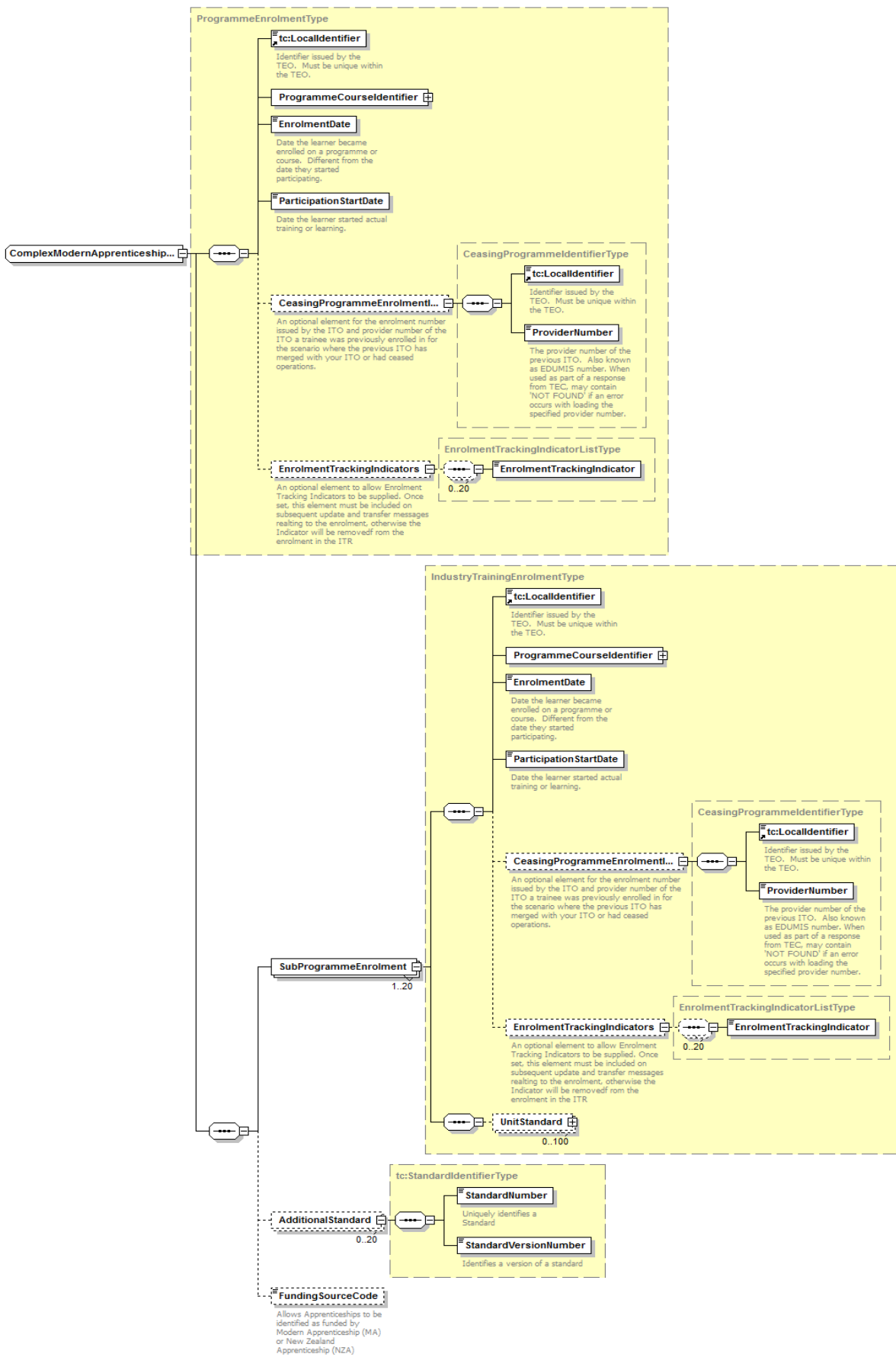

The above structure is comprised of two parts:

1. Enrolment information for the Modern Apprenticeship Enrolment itself. This structure shares elements from SimpleEnrolmentType including LocalIdentifier, ProgrammeCourseIdentifier, EnrolmentDate and ParticipationStartDate but does not include unit standards which are specified in the SubProgrammeEnrolment; and
2. SubProgrammeEnrolment – Details about the industry training programme enrolments that make up the modern apprenticeship enrolment and any additional unit standards which are part of the complex MA.

The table below describes each element in more detail:

Element name	Cardinality	Data type	Description
LocalIdentifier	1	Identifier Type	See section 5.5.4 for details.
ProgrammeCourse Identifier	1	Complex	See section 5.5.4 for details. Note: Only validation rules 1, 2 and 3 are applicable to Complex MA enrolments. Validation: The programme type must be valid for a complex MA enrolment i.e. "Complex MA".
EnrolmentDate	1	DateType	See section 5.5.4 for details.
ParticipationStart Date	1	DateType	See section 5.5.4 for details.
SubProgramme Enrolment	1..20	Complex	As described above, a MA programme enrolment may contain multiple enrolments in sub-programmes. See section 5.2.7 for details. Validation: 1 Each unit standard must only be reported once. For example, if 2 sub-programmes share a unit standard the MA enrolment should list the unit standard on only one of the enrolments; 2 Check that overarching programme is a complex MA. 3 Validate that the sub-programmes listed are registered for that Complex MA (see section 5.2.7). This means that the sub-programmes are listed against that MA. 4 All SubProgrammeCourseIdentifier numbers within the message must be unique. 5 Repeat the validation rules for 'simple enrolment' for each sub-programme except the following:

Element name	Cardinality	Data type	Description
			<ul style="list-style-type: none"> a where rules are not LCP or SCP specific b ignore EnrolmentDate validation and replace with sub-programme EnrolmentDate >= overarching programme EnrolmentDate c Add new validation rule; sub-programme ParticipationStartDate >= overarching programme ParticipationStartDate d Sub-Enrolment ParticipationStartDate may be greater than or equal to 1 January 2014
AdditionalStandard	0..20	Complex	<p>Additional standards that are not included in a specific sub-programme. See Section 5.2.7 for details about Additional Standards.</p> <p>Validation:</p> <p>Repeat the validation rules 1, 2, 3 and 4 for unit standards in section 5.5.4 plus the following:</p> <ul style="list-style-type: none"> 1 Must be a standard listed in the programme definition.
FundingSourceCode	0..1	Complex	<p>See section 5.5.4 for definition.</p> <p>Validation</p> <p>Where the value supplied = "MA" or "NZA" the learner cannot have any other "Active", "Pending", "Hold" or "Grace" MA or NZA enrolments at any ITO.</p> <p>The FundingSourceCode provided must be a valid value for the programme.</p> <p>Where the Funding Source Code is NZA the Programme Funding Source of NZA must be "Approved"</p> <p>Where the FundingSourceCode is NZA, the ParticipationStartDate of the overarching enrolment cannot be less than 1st Jan 2014</p> <p>Where the FundingSourceCode is MA the Date the message is received by ITR must be less than 1st April 2014</p>
CeasingProgrammeEnrolmentIdentifier	0..1	Complex	<p>The enrolment details at the ceasing ITO</p> <p>See section 4.6 for details</p>

Element name	Cardinality	Data type	Description
			<p>Additional Validation:</p> <p>The supplied enrolment ID must be valid</p> <p>The supplied enrolment must be for the same master NSN</p> <p>The programme version for this enrolment must be linked to the ceasing complex programme</p> <p>The participation start date of the new enrolment must be at least two days after the Participation Start Date of the ceasing enrolment</p> <p>The supplied enrolment must not be in a COMPLETED state</p> <p>The supplied enrolment must not be previously linked to by any other enrolment</p> <p>If the relationship between the linked ITO's is Transfer of Coverage; The supplied enrolment must be WITHDRAWN</p>
EnrolmentTrackingIndicator	0..20	Complex	<p>See section 4.7 for details</p> <p>Supplied Enrolment Tracking Indicators must be valid</p>

5.5.8 Validation flow diagram

Validation of Complex MA and NZA Enrolments are made up of three parts:

1. Learner Details – Details about the learner are validated as described in section 4.2.
2. Training Agreement – Rules relating to valid Training Agreement as described in section 5.5.

3. Complex Modern Apprenticeships validation – Rules relating to Complex Modern Apprenticeships performed as per the diagram below:

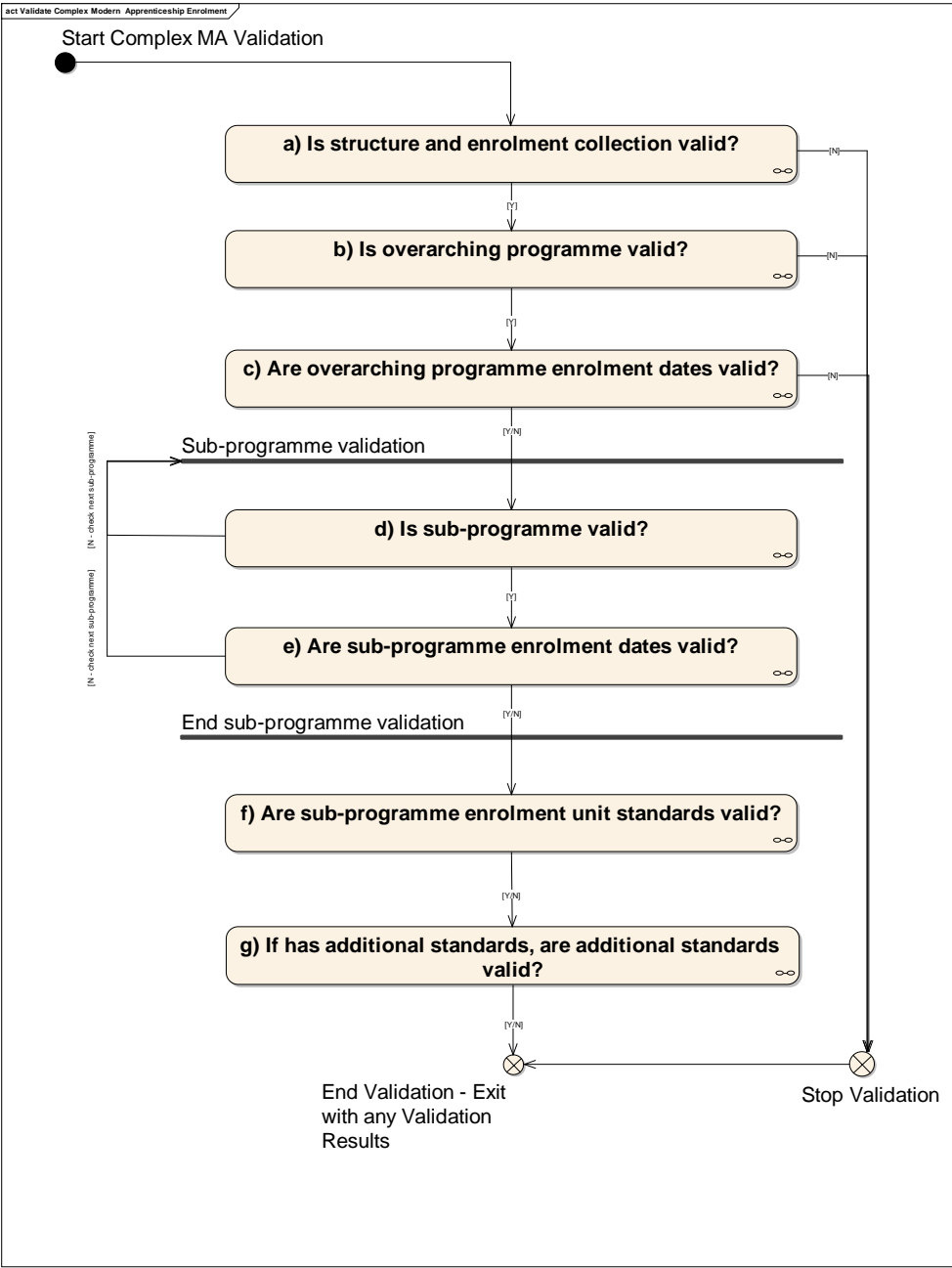

a. Is structure and enrolment collection valid?

Is Structure and Enrolment Collection Valid activity diagram

Start Complex MA or NZA Validation – Validate MA or NZA, Structure and Enrolment Collection

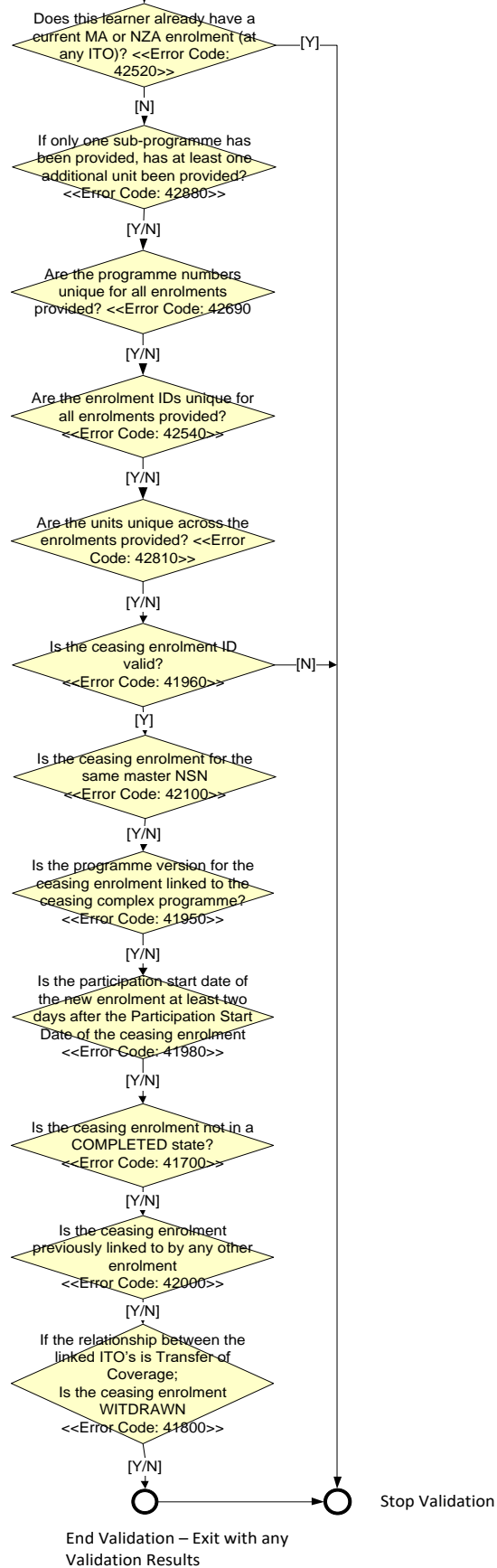

b. Is overarching programme validation valid?

Is Overarching Programme Valid?

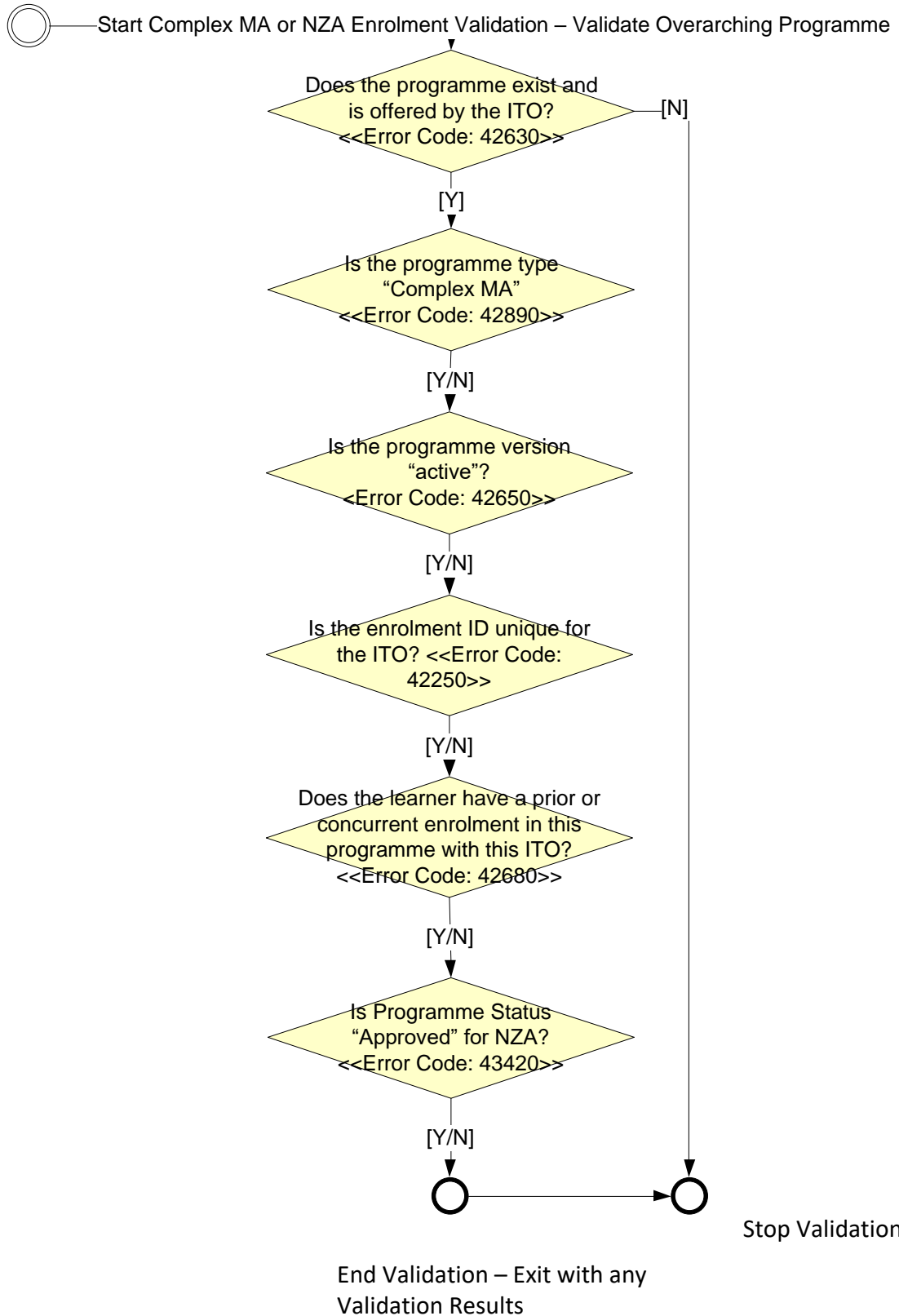

c. Are overarching programme enrolment dates valid?

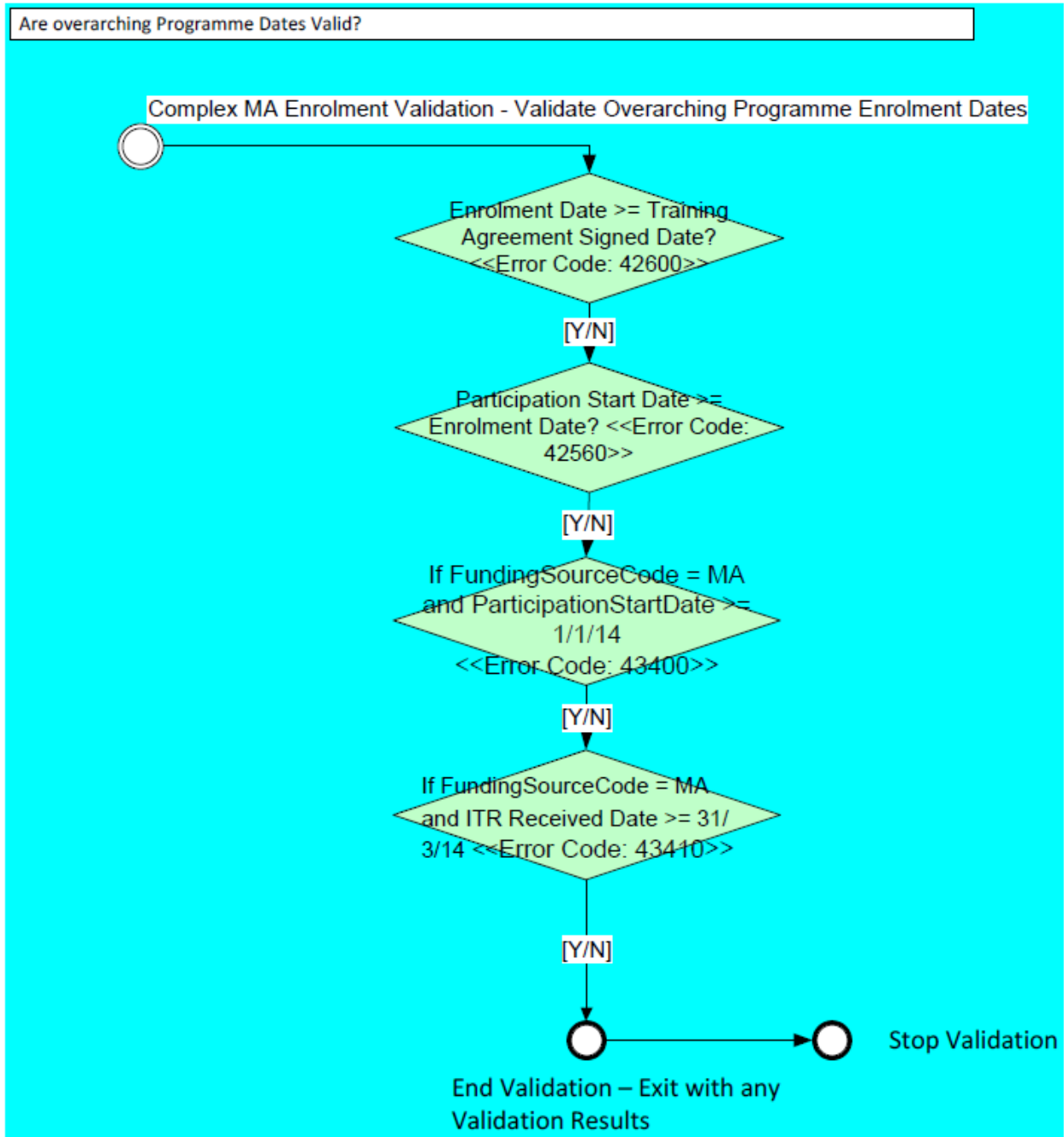

d. Is sub-programme valid?

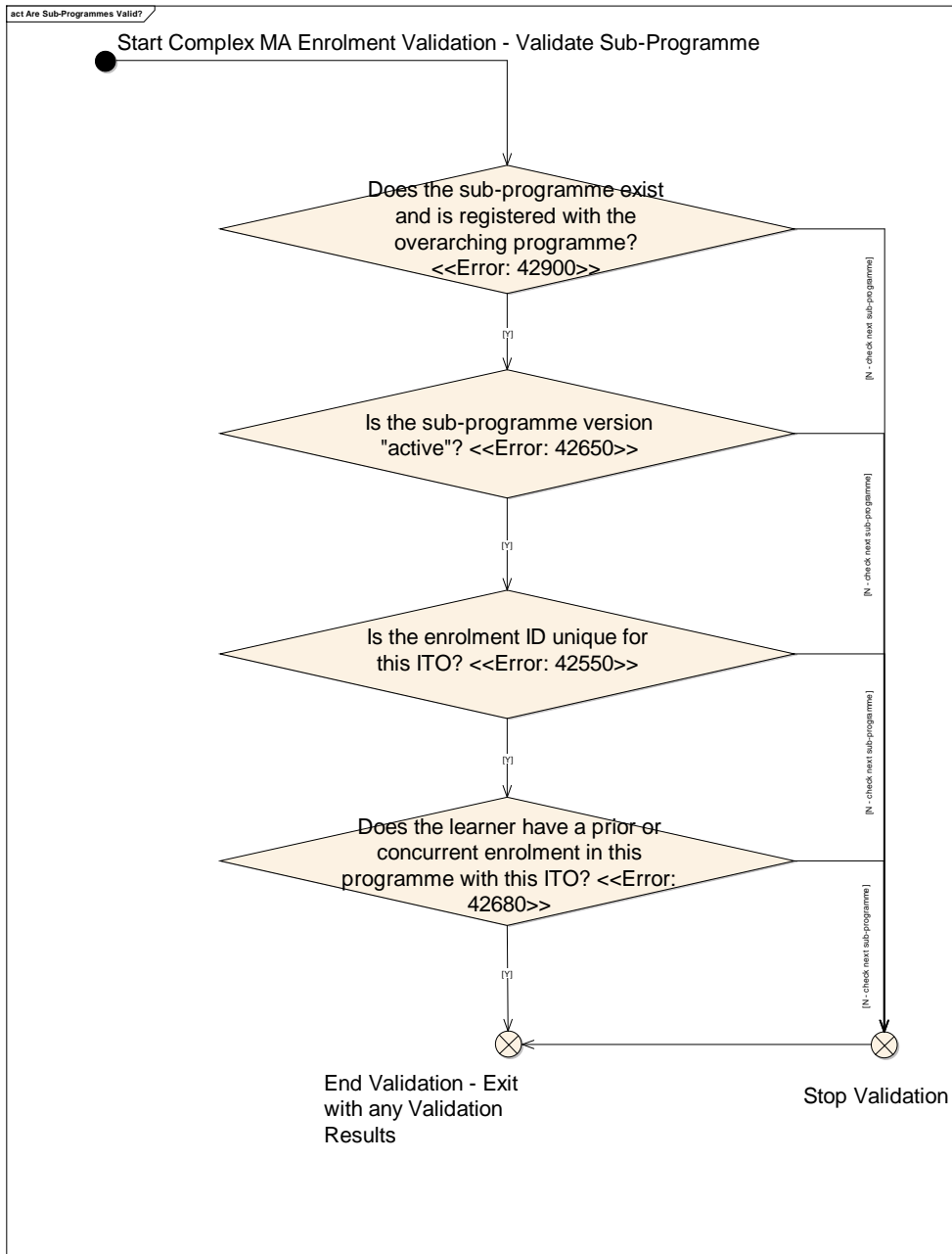

e. Are sub-programme enrolment dates valid?

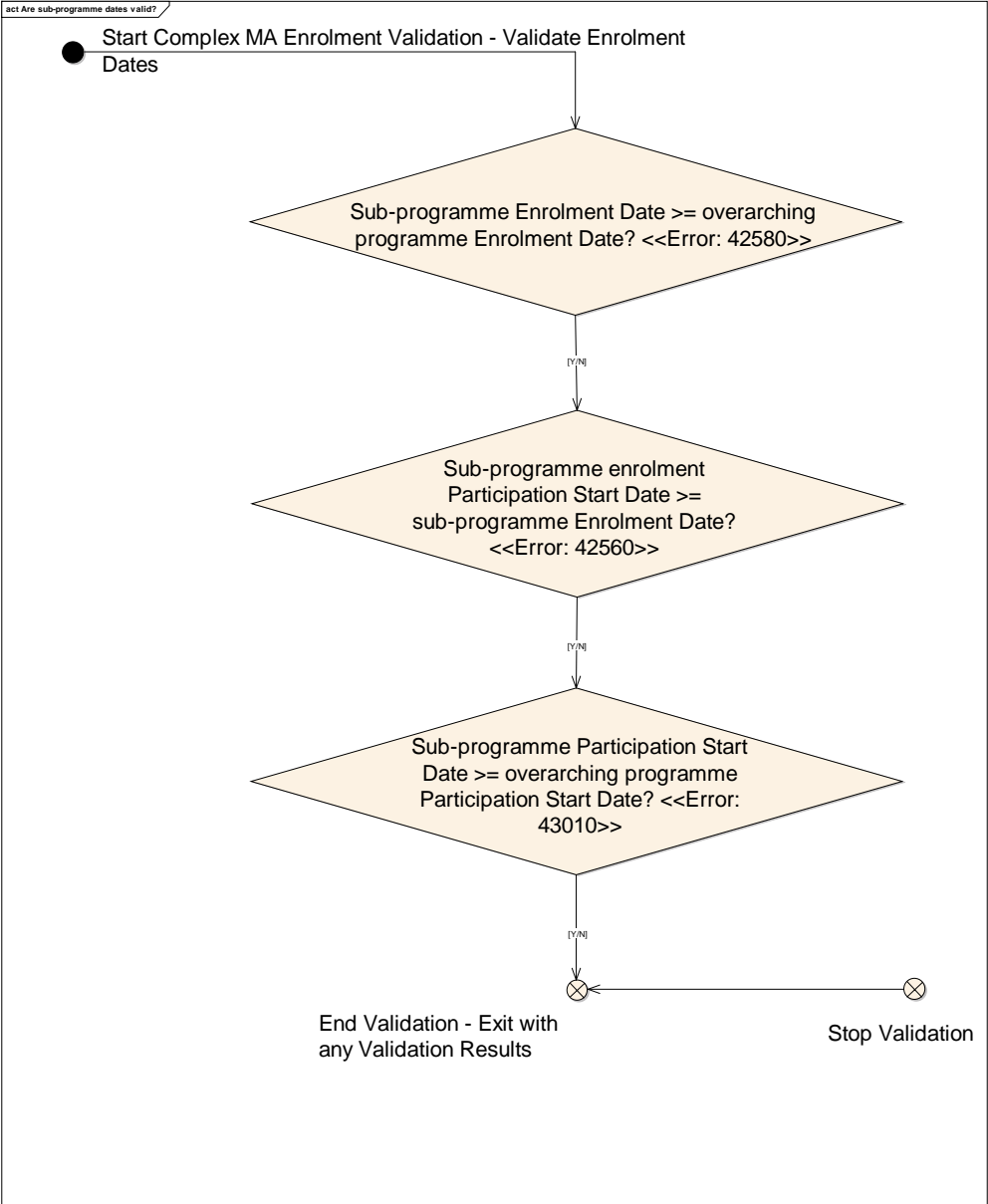

f. Are sub-programme enrolment unit standards valid?

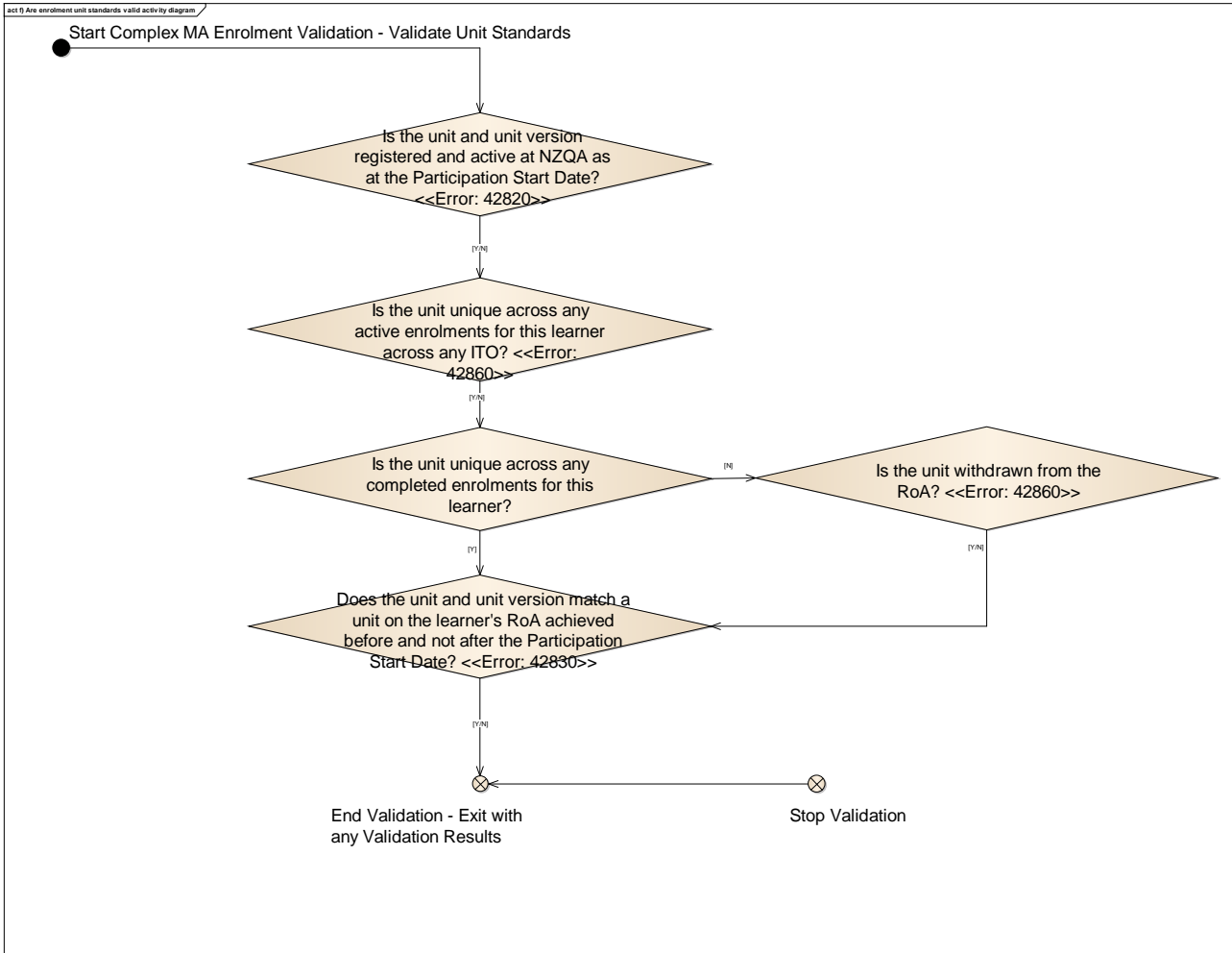

a. Are additional standards valid?

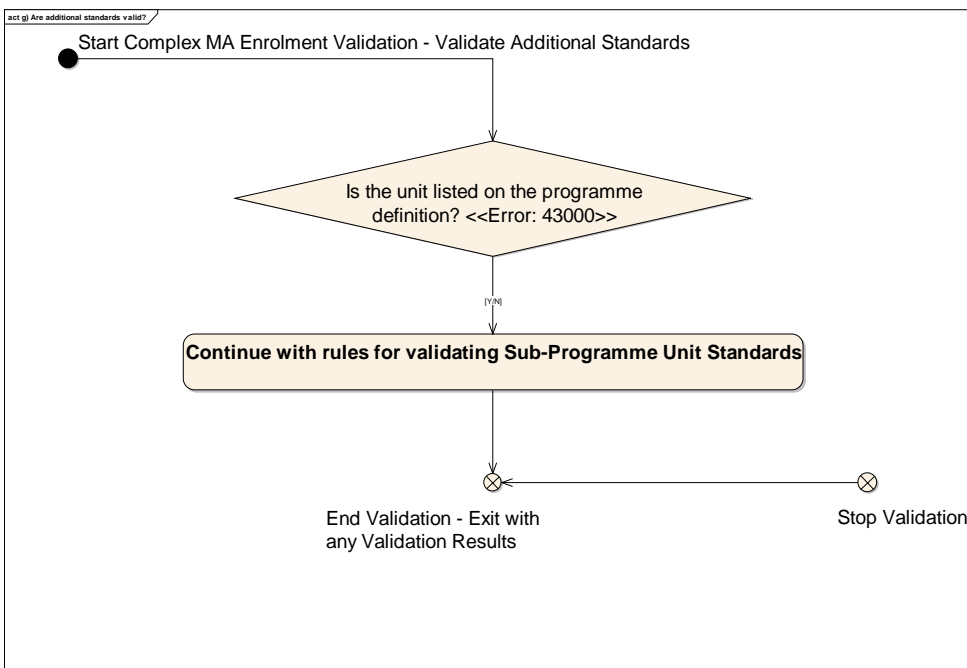

5.5.9 Business rules

The following business rules are applied if the Create Training Agreement and Create Complex MA Enrolment details are valid:

ID	Rule Description
1	Set the status of the training agreement to "Pending".
2	Set the status of the enrolment to "Pending".
3	Set the original training agreement signed date to the training agreement signed date. Note: The original training agreement signed date is required to be captured as the Transfer Employer message will create another Training Agreement for the enrolment, resulting in multiple training agreement signed dates. Refer to section 5.11 for further details. The original training agreement signed date (rather than the current training agreement signed date) will be used for Update and Add Enrolment validations.
4	ITR will create a history record to capture the changes – refer to Section.7.7.
5	Registration for MA-funded enrolments with Participation Start Date after 1 st January 2014 are not valid

5.6 Withdraw from training agreement (E12)

The ITR allows an ITO to withdraw a training agreement when the agreement between the trainee, employer and ITO ceases before the related enrolments have been completed. The effect of withdrawing a training agreement is to also withdraw all enrolments within the agreement that have not yet been completed or withdrawn.

Where an ITO wants to change how an enrolment is funded they should update the enrolment using the update enrolment messages as per sections 5.13 and 5.14.

The diagram below shows the elements required to withdraw a training agreement.

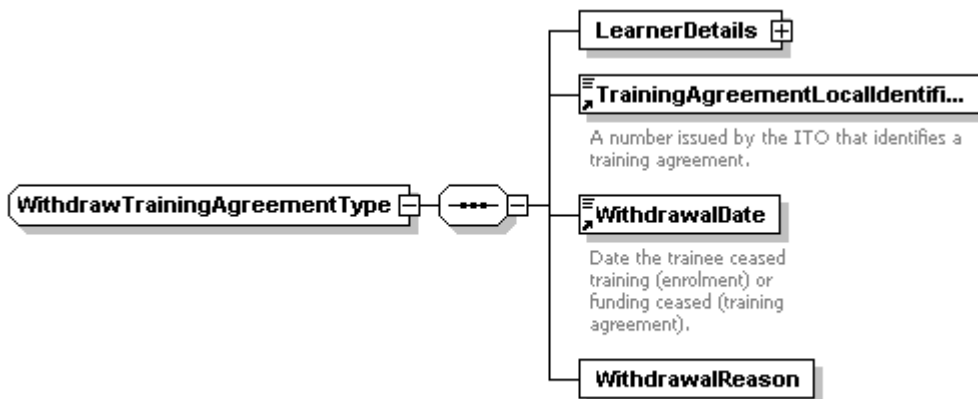

Generated with XMLSpy Schema Editor www.altova.com

The table below describes the elements in this message in more detail

Element name	Cardinality	Data type	Description
LearnerDetails	1	Complex	See section 4.2 for details.
TrainingAgreement LocalIdentifier	1	Identifier Type	<p>A unique number issued by the ITO that identifies the training agreement.</p> <p>Validation:</p> <ol style="list-style-type: none"> 1 Must match a training agreement registered by the ITO. 2 Must match a training agreement for the learner identified in LearnerDetails for this TrainingAgreementLocalIdentifier. 3 Training Agreement must have a status of "Pending", "Active", "Hold" or "Grace" to be withdrawn
WithdrawalDate	1	DateType	<p>The date the withdrawal is effective.</p> <p>Validation:</p> <ol style="list-style-type: none"> 1 WithdrawalDate >= TrainingAgreement SignedDate 2 WithdrawalDate <= Today 3 WithdrawalDate >= LatestEnrolmentParticipationStartDate

Element name	Cardinality	Data type	Description
WithdrawalReason	1	Code Type	<p>A code that identifies the reason why a training agreement is being withdrawn.</p> <p>Validation:</p> <p>1 Must come from the list in Section 5.12.</p>

5.6.1 Validation flow diagram

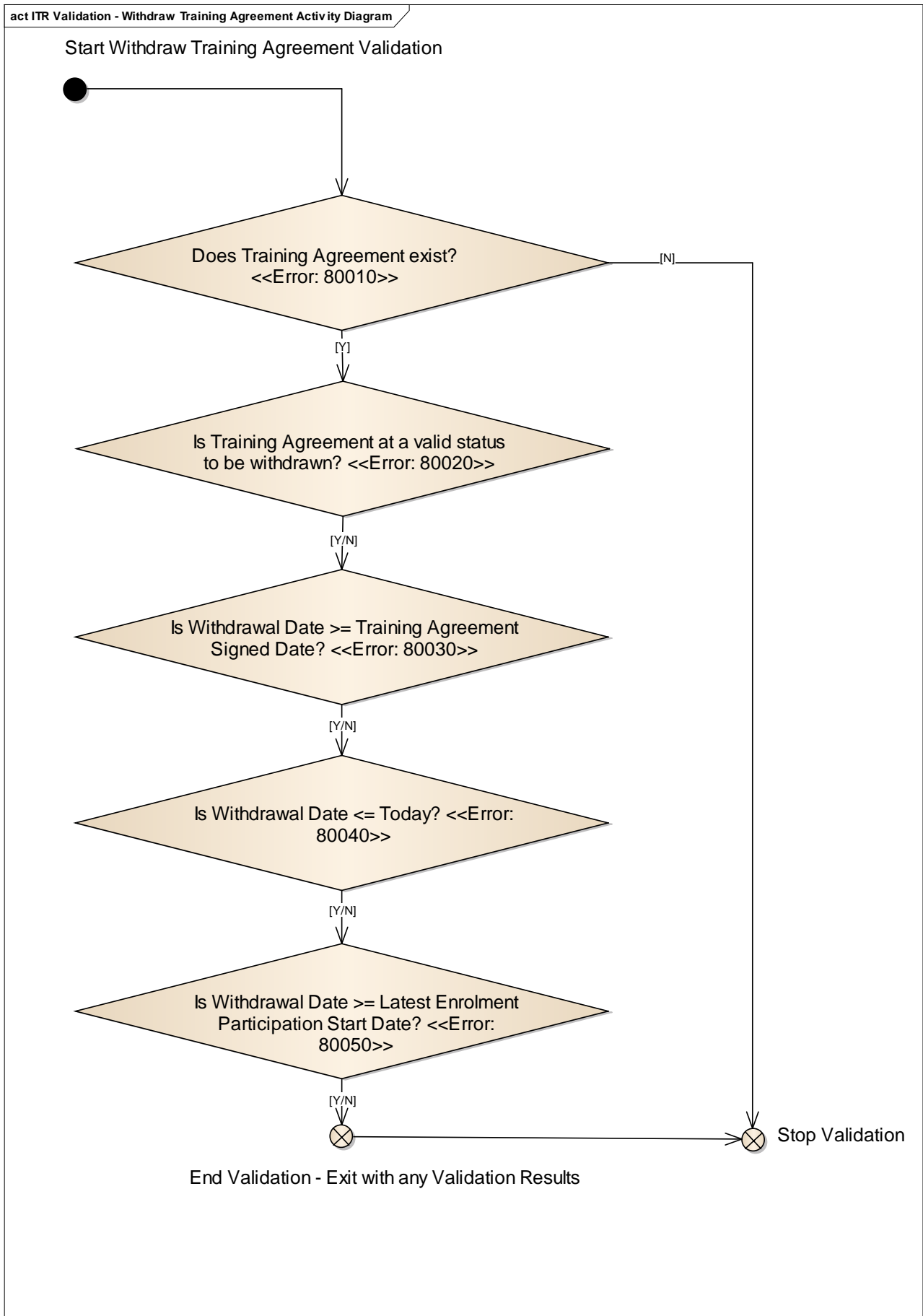

5.6.2 Business rules

The following business rules are applied if the Withdraw Training Agreement details are valid:

ID	Rule Description
1	Create the withdraw training agreement event and associate it with the original training agreement.
2	Update the training agreement status to “Finished”. ITR will create a history record to capture the changes to the training agreement – refer to Section.7.7.
3	<p>For all enrolments associated with the training agreement that are “Active”, “Pending”, “Hold”, “Grace” (i.e. not “Completed” or “Withdrawn”):</p> <ul style="list-style-type: none">Create a withdraw enrolment event and associate it with the original enrolment.Change the status of the enrolment to “Withdrawn”.Update the enrolment actual end date to the withdrawal date.ITR will create history records to capture these changes to the enrolments – refer to Section.7.7. <p>Note that for complex MA or NZA, the updates listed above apply to the overarching enrolment and each of the sub-programme enrolments.</p>
4	If a current training plan exists, the training plan end date will be set to the training agreement withdrawal date.

5.7 Update training agreement (E13)

The purpose of the UpdateTrainingAgreement message is to allow ITOs to inform the ITR of changes to a trainees training agreement, for example typos or other mistakes not involving change in employer. **Update Training Agreement must not be used if the employer has changed.** Please withdraw the training agreement and re-enrol with the new employer's details.

This message does not allow for changes to enrolment information which are contained in the UpdateProgrammeEnrolment message.

The diagram below shows the information an ITO may update about a training agreement.

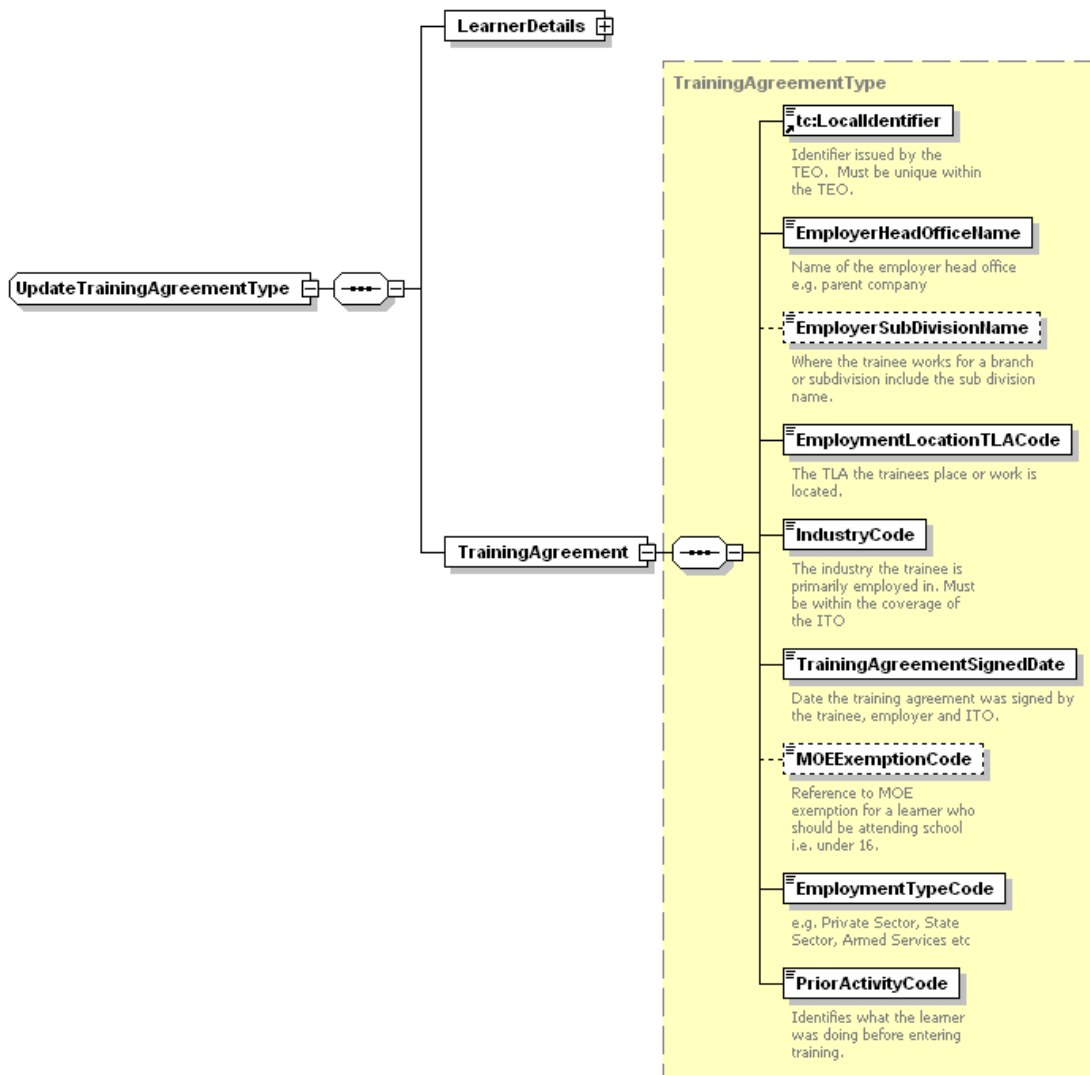

Generated with XMLSpy Schema Editor www.altova.com

The table below describes the elements in the diagram in more detail.

Element name	Cardinality	Data type	Description
LearnerDetails	1	Complex	Common learner information supplied with all messages. See section 4.2 for details.
LocalIdentifier	1	Identifier Type	See section 5.5 for a definition. Validation: 1 Must match a training agreement that belongs to the learner as identified in LearnerDetails and for the ITO that submitted the message 2 TrainingAgreement must not have a status of "Finished".
EmployerHead OfficeName	1	NameType	See section 5.5 for a definition. As noted above, changes to this field should be to correct a mistake (e.g. a typo). To change the actual employer, please use the Transfer Employer message. Refer to section 5.11.
EmployerSub DivisionName	0..1	NameType	See section 5.5 for a definition.
EmploymentLocation TLACode	1	CodeType	See section 5.5 for a definition and base validation rules. Validation: As per section 5.5.
IndustryCode	1	CodeType	See section 5.5 for a definition and base validation rules. Validation: As per section 5.5.
TrainingAgreement SignedDate	1	DateType	See section 5.5 for a definition. Validation: TrainingAgreementSignedDate must be the same as the old TrainingAgreementSignedDate i.e. this field cannot be updated. The supplied training agreement signed date must be on or before the enrolment date of any associated enrolments The supplied training agreement signed date must be on or before the participation start date of any associated enrolments The supplied training agreement signed date must be on or before the Training Plan signed date.

Element name	Cardinality	Data type	Description
			<p>The supplied training agreement signed date must be before any hold or grace event dates</p> <p>Training Agreement Signed date cannot be updated for FINISHED training agreements</p>
MOEExemptionCode	0..1	xs:string	<p>See section 5.5 for a definition and base validation rules.</p> <p>Validation:</p> <p>As per section 5.5</p>
EmploymentTypeCode	1	CodeType	<p>See section 5.2 for a definition and base validation rules.</p> <p>Validation:</p> <p>As per section 5.5.</p>
PriorActivityCode	1	CodeType	<p>See section 5.2 for a definition and base validation rules.</p> <p>Validation:</p> <p>As per section 5.5.</p>

5.7.1 Validation flow diagram

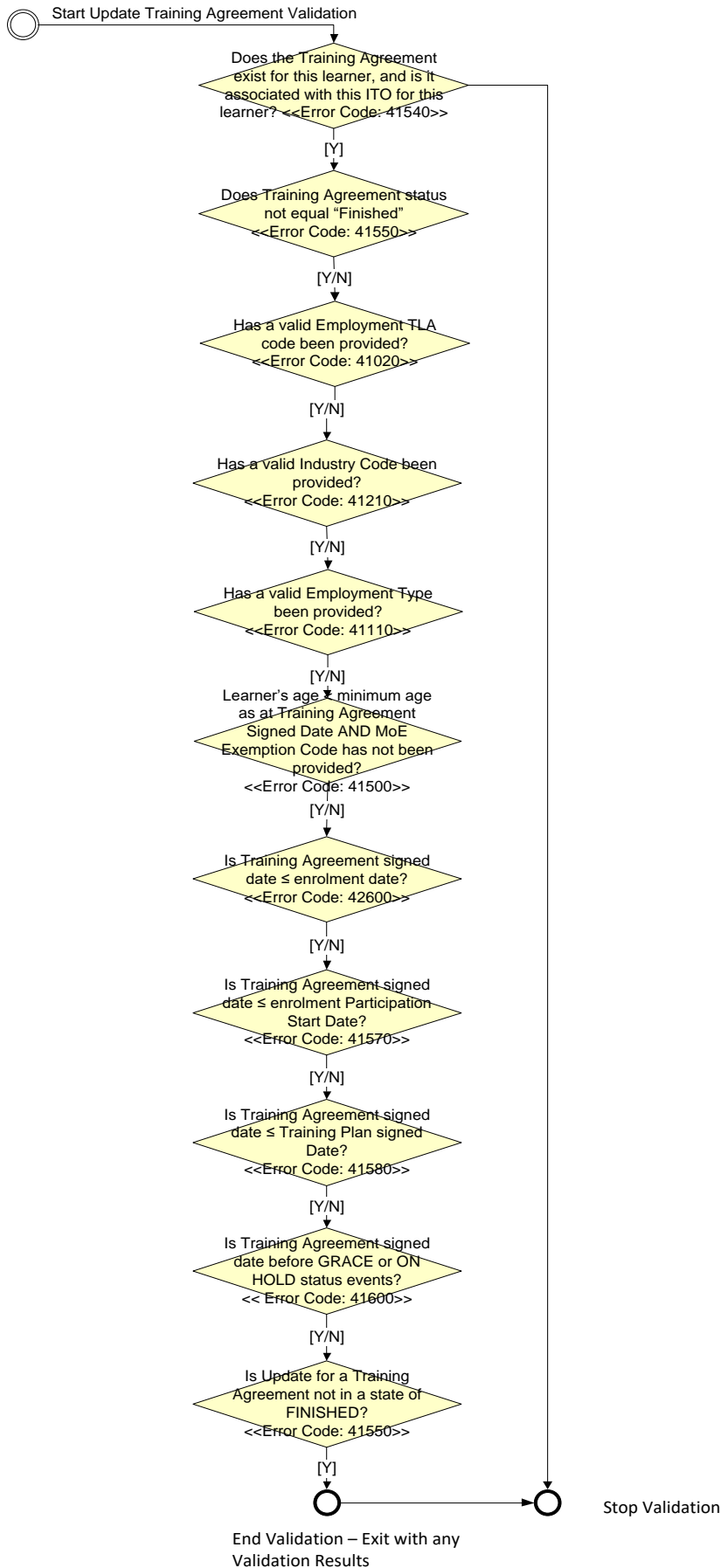

5.7.2 Business rules

The following business rules are applied if the Update Training Agreement details are valid:

ID	Rule Description
1	Create the update training agreement event and associate it with the original training agreement.
2	The following elements are updatable on the Update Training Agreement message: <ul style="list-style-type: none"><li data-bbox="363 472 783 506">• Employer Head Office Name<li data-bbox="363 533 794 566">• Employer Sub Division Name<li data-bbox="363 593 834 627">• Employment Location TLA Code<li data-bbox="363 654 592 687">• Industry Code<li data-bbox="363 714 703 748">• MOE Exemption Code<li data-bbox="363 775 727 808">• Employment Type Code<li data-bbox="363 835 651 869">• Prior Activity Code
3	<ul style="list-style-type: none"><li data-bbox="363 891 1305 958">• ITR will create a history record to capture the changes to the training agreement – refer to Section.7.7.<li data-bbox="363 985 1380 1153">• On the original training agreement learner event:<ul style="list-style-type: none"><li data-bbox="459 1041 1380 1108">○ Update Event Occurred Date to the new training agreement signed date.<li data-bbox="459 1135 1313 1153">○ Update Event Reported Date to the message processing date

5.8 Place training agreement on hold (E14)

This message allows an ITO to place a training agreement on hold temporarily to reflect that the trainee is not actively training but intends to resume training. Placing a training agreement on hold means that associated enrolments no longer accrue STMs. TEC expects ITOs to report trainees as on hold as soon as they become aware training has been temporarily halted.

The hold can be ended in the following ways:

- withdrawing the training agreement (refer to section 5.6)
- the Restart Training Agreement message is successfully processed
- transfer of employer (refer to section 5.11)

The diagram below shows the elements that make up a hold training agreement message.

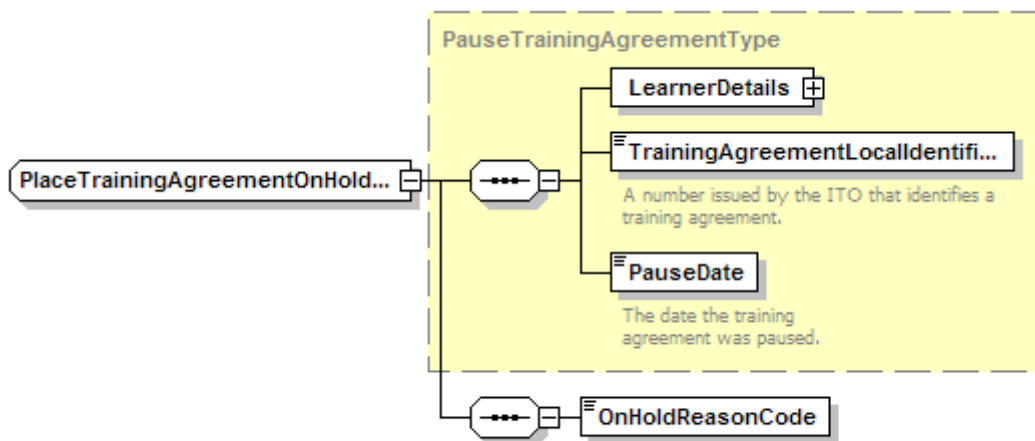

Generated with XMLSpy Schema Editor www.altova.com

The table below describes this message in more detail.

Element name	Cardinality	Data type	Description
LearnerDetails	1	Complex	See section 4.2 for details.
TrainingAgreement LocalIdentifier	1	Identifier Type	<p>A number issued by the ITO that uniquely identifies the training agreement.</p> <p>Validation:</p> <ol style="list-style-type: none"> 1 Must match a training agreement that belongs to the learner as identified in LearnerDetails and for the ITO that submitted the message. 2 Training Agreement must have a status of "Active", "Pending" or "Grace" to be placed on hold.

Element name	Cardinality	Data type	Description																		
PauseDate	1	DateType	<p>The date from which the training agreement should be placed on hold.</p> <p>Validation:</p> <p>1 PauseDate > TrainingAgreementSignedDate</p> <p>2 PauseDate <= Today</p>																		
OnHoldReasonCode	1	Code Type	<p>Identifies why the training agreement is being put on hold.</p> <p>Validation:</p> <p>1 Must be from the following list:</p> <table border="1"> <thead> <tr> <th>Value</th> <th>Description</th> </tr> </thead> <tbody> <tr> <td>SW</td> <td>Seasonal work</td> </tr> <tr> <td>PL</td> <td>Parental leave</td> </tr> <tr> <td>OV</td> <td>Overseas travel</td> </tr> <tr> <td>MD</td> <td>Medical/ACC</td> </tr> <tr> <td>CI</td> <td>Attending correctional institution</td> </tr> <tr> <td>OT</td> <td>Other</td> </tr> <tr> <td>ST</td> <td>Stop training (still with employer)</td> </tr> <tr> <td>WE</td> <td>Work Experience</td> </tr> </tbody> </table>	Value	Description	SW	Seasonal work	PL	Parental leave	OV	Overseas travel	MD	Medical/ACC	CI	Attending correctional institution	OT	Other	ST	Stop training (still with employer)	WE	Work Experience
Value	Description																				
SW	Seasonal work																				
PL	Parental leave																				
OV	Overseas travel																				
MD	Medical/ACC																				
CI	Attending correctional institution																				
OT	Other																				
ST	Stop training (still with employer)																				
WE	Work Experience																				

5.8.1 Validation flow diagram

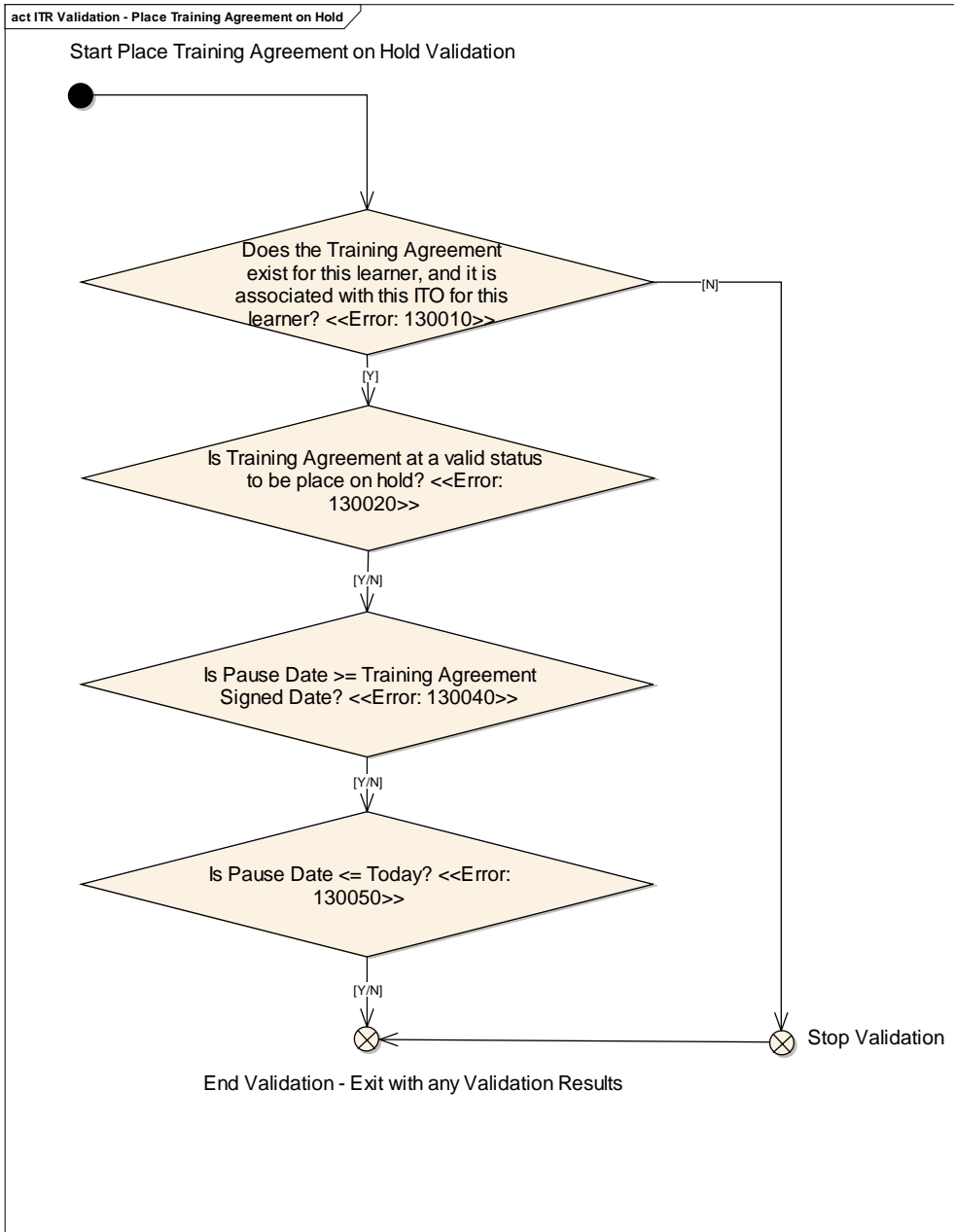

5.8.2 Business rules

The following business rules are applied if the Place Training Agreement on Hold details are valid:

ID	Rule Description
1	Update the status of the training agreement and all associated enrolments whose statuses are “Active”, “Pending” or “Grace” to “Hold”.
2	Create a history record to capture the changes – refer to Section.7.7.
3	Set the Hold start date to the Pause Date specified in the message. Note: the Hold end date has a default value of null but will be set to the Restart Date specified in the Restart Training Agreement message.

5.9 Start training agreement grace period (E15)

TEC funding rules allow a trainee who has lost their job to continue funded training for a ‘grace period’. Current policy is 6 weeks (42 days) while the ITO helps the trainee complete the programme or obtain another job. At the end of the grace period TEC will cease funding of the trainee however the ITO may choose to continue training but will not receive TEC funding for this.

The grace period can be ended in the following ways:

- withdrawing the training agreement (refer to section 5.6)
- the grace period elapses and the training agreement status is set to “Finished”
- transfer of employer (refer to section 5.11)
- moving the training agreement to being put on hold (refer to section 5.8)

The diagram below describes the structure of the message to place the training agreement into a grace period.

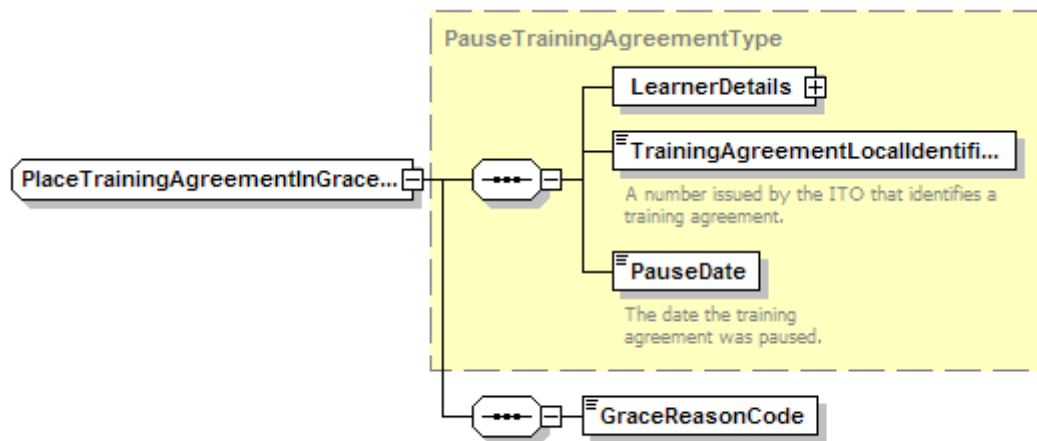

Generated with XMLSpy Schema Editor www.altova.com

The table below describes this message in more detail.

Element name	Cardinality	Data type	Description
LearnerDetails	1	Complex	See section 4.2 for details.
TrainingAgreement LocalIdentifier	1	Identifier Type	<p>A number issued by the ITO that uniquely identifies the training agreement.</p> <p>Validation:</p> <ol style="list-style-type: none"> 1 Must match a training agreement that belongs to the learner as identified in LearnerDetails and for the ITO that submitted the message. 2 Training Agreement must have a status of “Active” or “Pending” to be placed into a grace period.

Element name	Cardinality	Data type	Description								
PauseDate	1	DateType	<p>The date from which the training agreement should be placed in grace. The ITR will set the training agreement end date to PauseDate + grace period parameter. After this date the training agreement status will be set to "Finished" and the associated enrolment(s) (not "Withdrawn" or "Completed") will be set to "Withdrawn".</p> <p>Validation:</p> <ol style="list-style-type: none"> 1 PauseDate > TrainingAgreementSigned Date 2 PauseDate <= Today 								
GraceReasonCode	1	Code Type	<p>Identifies whether the training agreement is being put into a grace period.</p> <p>Validation:</p> <ol style="list-style-type: none"> 1 Must be from the following list: <table border="1"> <thead> <tr> <th>Value</th> <th>Description</th> </tr> </thead> <tbody> <tr> <td>LE</td> <td>Loss of employment</td> </tr> <tr> <td>DM</td> <td>Dismissal</td> </tr> <tr> <td>RD</td> <td>Redundancy</td> </tr> </tbody> </table>	Value	Description	LE	Loss of employment	DM	Dismissal	RD	Redundancy
Value	Description										
LE	Loss of employment										
DM	Dismissal										
RD	Redundancy										

5.9.1 Validation flow diagram

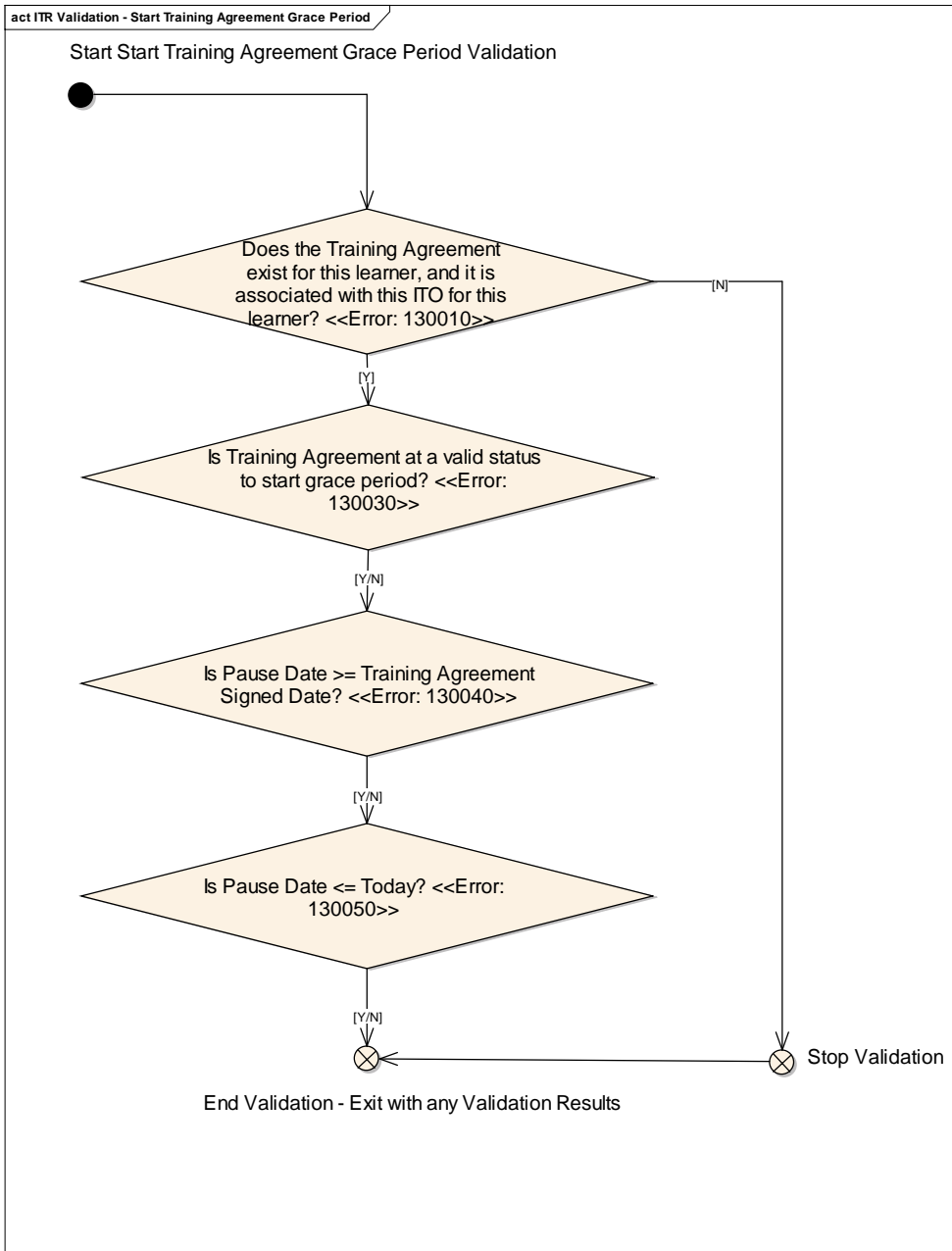

5.9.2 Business rules

The following business rules are applied if the Start Training Agreement Grace Period details are valid:

ID	Rule Description
1	Update the status of the training agreement and all associated enrolments whose statuses are “Active” or “Pending” to “Grace”.
2	Set the training agreement end date to “x” number of days from the Pause Date where “x” is the grace period parameter.
3	ITR will create history records to capture the changes to the training agreement in steps 1 and 2 – refer to Section.7.7.

ID	Rule Description
4	For any enrolments that are updated in step 1, ITR will create history records to capture the changes – refer to Section.7.7.

5.10 Restart training agreement (E16)

An ITO may place a training agreement on hold. When the hold ends the ITO needs to be able to restart the training agreement for funding purposes

An ITO may place a trainee on hold if the trainee is not actively training but intends to return to training within a short period of time. This transaction allows the ITO to remove the hold on a training agreement so that STMs start accruing for the related enrolments. See section 5.8 for details on how to put a training agreement on hold.

The diagram below describes the elements required to restart a training agreement previously placed on hold.

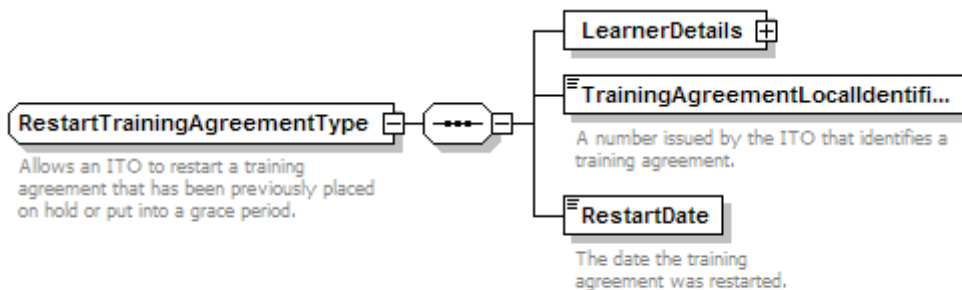

Generated with XMLSpy Schema Editor www.altova.com

The table below describes the restart training agreement message in more detail.

Element Name	Cardinality	Data Type	Description
LearnerDetails	1	Complex	See section 4.2 for details.
TrainingAgreement LocalIdentifier	1	Identifier Type	A unique number issued by the ITO that identifies the training agreement. Validation: 1 Must match a training agreement that belongs to the learner as identified in LearnerDetails and for the ITO that submitted the message. 2 Training Agreement must have a status of "Hold" to be restarted.
RestartDate	1	DateType	The date from which the training agreement should be restarted. Validation 1 RestartDate >= current hold Start Date i.e. the PauseDate specified in the hold message

5.10.1 Validation flow diagram

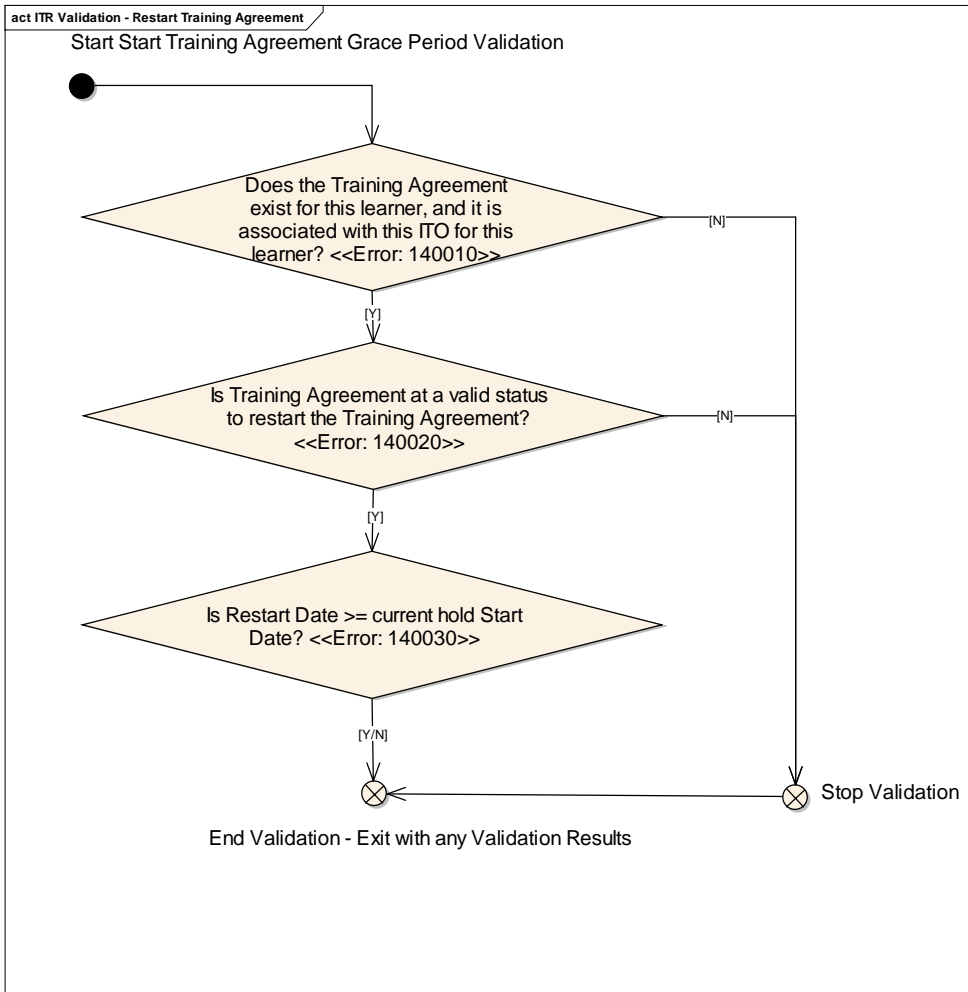

5.10.2 Business rules

The following business rules are applied if the Restart Training Agreement details are valid:

ID	Rule Description
1	Update the status of the training agreement and associated enrolments (not “Withdrawn” or “Completed”) to “Active”, unless it is for an MA or NZA enrolment and a Training Plan does not exist for it. In the latter scenario, the status of the training agreement and associated enrolments (not “Withdrawn” or “Completed”) will be set to “Pending”.
2	ITR will create a history record to capture the changes – refer to Section.7.7.

5.11 Transfer employer (E17)

Trainees sometimes change employer during the course of their training. When this happens the enrolment continues but the training agreement with the old employer is ended and a new training agreement is created. An ITO can inform the ITR about a change in employer using the Transfer Employer message which contains details about the new training agreement but not about the related enrolments which have already been recorded in the ITR. If the ITO wants to amend the enrolments as well they can either submit a separate update enrolment message or withdraw the training agreement and re-enrol the trainee.

Following successful validation of the Transfer Employer message the ITR will:

1. End the existing training agreement
2. Create a new training agreement using the details supplied in the message
3. Transfer the enrolments in the original training agreement so that they are associated with the new training agreement.

The diagram below shows the elements required to transfer employer:

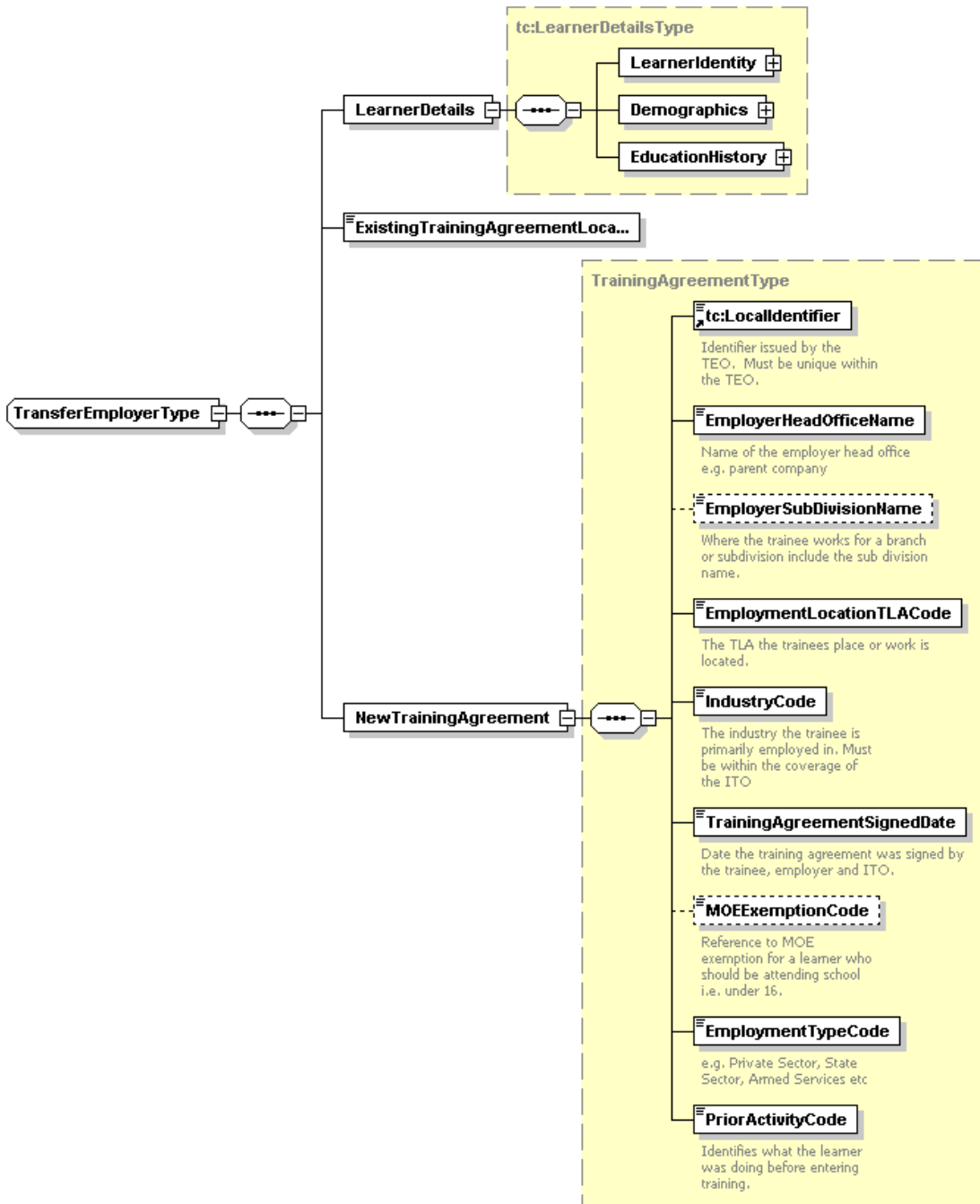

Generated with XMLSpy Schema Editor www.altova.com

In general, the same validation is completed as per section 5.5.

The table below describes the elements required to transfer an employer in more detail, and lists additional validations:

Element Name	Cardinality	Data Type	Description
LearnerDetails	1	Complex	See section 4.2 for details.
TrainingAgreement Identifier	1	Complex	See section 5.5 for details Validation: 1 Training agreement must not be "Finished".
NewTraining Agreement	1	Complex	Details about the new employer and the new training agreement. Please note that this does not include the enrolment details again as they have already been stored in the ITR. If the enrolments have changed as well then a separate enrolment update must be sent to the ITR after the transfer employer has been processed. Note: If a transfer in ITO is required, the old ITO will need to withdraw the training agreement and the new ITO will need to create a new training agreement and associated enrolments.
LocalIdentifier	1	Identifier Type	See section 5.5 for a description of this element. In this context LocalIdentifier identifies the new training agreement. 1 Must be unique for the ITO and different from the LocalIdentifier used on the previous training agreement.
EmployerHead OfficeName	1	Name Type	See section 5.5 for a definition. 1 Validate that either one of the EmployerHeadOfficeName, EmployerSubDivisionName or EmploymentLocationTLACode has changed from the previous training agreement.
EmployerSub DivisionName	0..1	Name Type	See section 5.5 for a definition.
Employment Location TLACode	1	Code Type	See section 5.5 for a definition and base validation rules.
IndustryCode	1	Code Type	See section 5.5 for a definition and base validation rules.
TrainingAgreement SignedDate	1	DateType	Identifies the date that the new training agreement was signed.

Element Name	Cardinality	Data Type	Description
			<p>Repeat validation rules 1 and 2 in section 5.5 plus the following.</p> <p>Validation:</p> <ol style="list-style-type: none"> 1. TrainingAgreementSignedDate > TrainingAgreementSignedDate on the old training agreement. 2. TrainingAgreementSignedDate must occur at least 1 day after any preceding GRACE event(s) for the previous Training Agreement.
MOEExemption Code	0..1	Code Type	See section 5.5 for a definition and base validation rules.
EmploymentType Code	1	Code Type	See section 5.5 for a definition and base validation rules.
PriorActivityCode	1	Code Type	See section 5.5 for a definition and base validation rules.

5.11.1 Validation flow diagram

ITR Validation – Transfer Employer

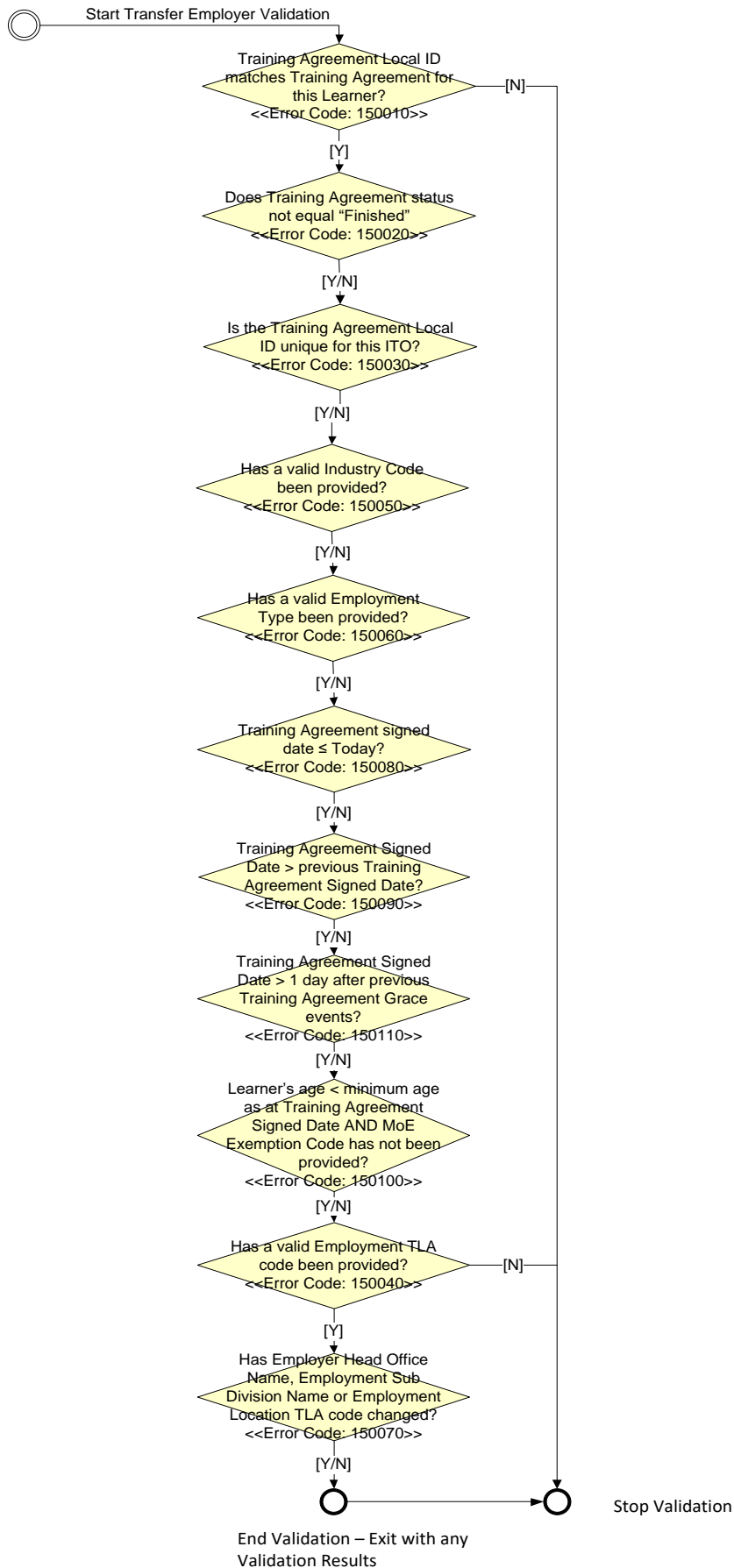

5.11.2 Business Rules

The following business rules are applied if the Transfer Employer details are valid:

ID	Rule Description												
1	Take a history of the old training agreement then update the status to “Finished” and set the end date of the old training agreement to the new training agreement signed date minus 1 day.												
2	<p>Create new training agreement with details provided. Set the status of the new training agreement as follows:</p> <table border="1" data-bbox="312 510 1406 1368"> <thead> <tr> <th data-bbox="312 510 858 568">Old Training Agreement Status</th> <th data-bbox="858 510 1406 568">New Training Agreement Status</th> </tr> </thead> <tbody> <tr> <td data-bbox="312 568 858 629">Active</td> <td data-bbox="858 568 1406 629">Active</td> </tr> <tr> <td data-bbox="312 629 858 689">Pending</td> <td data-bbox="858 629 1406 689">Pending</td> </tr> <tr> <td data-bbox="312 689 858 981">Hold</td> <td data-bbox="858 689 1406 981">Set the status of the new training agreement to “Active” if IT or TA enrolment or MA/NZA enrolment with current training plan in place (on old training agreement). If MA enrolment without a current training plan (on old training agreement), set the status to “Pending”.</td> </tr> <tr> <td data-bbox="312 981 858 1272">Grace</td> <td data-bbox="858 981 1406 1272">Set the status of the new training agreement to “Active” if IT or TA enrolment or MA and NZA enrolment with current training plan in place (on old training agreement). If MA or NZA enrolment without a current training plan (on old training agreement), set the status to “Pending”.</td> </tr> <tr> <td data-bbox="312 1272 858 1368">Finished</td> <td data-bbox="858 1272 1406 1368">N/A – invalid to transfer employer from a finished training agreement</td> </tr> </tbody> </table>	Old Training Agreement Status	New Training Agreement Status	Active	Active	Pending	Pending	Hold	Set the status of the new training agreement to “Active” if IT or TA enrolment or MA/NZA enrolment with current training plan in place (on old training agreement). If MA enrolment without a current training plan (on old training agreement), set the status to “Pending”.	Grace	Set the status of the new training agreement to “Active” if IT or TA enrolment or MA and NZA enrolment with current training plan in place (on old training agreement). If MA or NZA enrolment without a current training plan (on old training agreement), set the status to “Pending”.	Finished	N/A – invalid to transfer employer from a finished training agreement
Old Training Agreement Status	New Training Agreement Status												
Active	Active												
Pending	Pending												
Hold	Set the status of the new training agreement to “Active” if IT or TA enrolment or MA/NZA enrolment with current training plan in place (on old training agreement). If MA enrolment without a current training plan (on old training agreement), set the status to “Pending”.												
Grace	Set the status of the new training agreement to “Active” if IT or TA enrolment or MA and NZA enrolment with current training plan in place (on old training agreement). If MA or NZA enrolment without a current training plan (on old training agreement), set the status to “Pending”.												
Finished	N/A – invalid to transfer employer from a finished training agreement												
3	Set the “original signed date” on the new training agreement to the “original signed date” from the old training agreement.												
4	Take a history of any enrolments (not “Withdrawn” or “Completed”) from the old training agreement, and then transfer the current enrolment records to the new training agreement. Update the status of these enrolments to match the status of the new training agreement.												
5	Transfer the current training plan (if one exists) from the old training agreement to the new training agreement.												
	<p>Note: Updates to enrolments and the addition of new enrolments under the new training agreement should have the enrolment date validated against the original training agreement signed date not the new training agreement signed date. Regardless of the number of transfers that have occurred, the original training agreement signed date should be validated against.</p>												

5.12 Withdraw enrolment (E18)

Where a trainee or modern apprentice is unable to complete their enrolment(s) the ITO is required to submit a withdrawal transaction as soon as the ITO becomes aware that training has ceased to occur. This is a TEC requirement to ensure accurate calculation of STM's.

The same withdrawal message is used regardless of the type of enrolment although the validation rules for Complex MAs/NZAs withdrawals are different from those for LCP, SCP and NQ withdrawals.

The diagram below describes the structure of the withdrawal message:

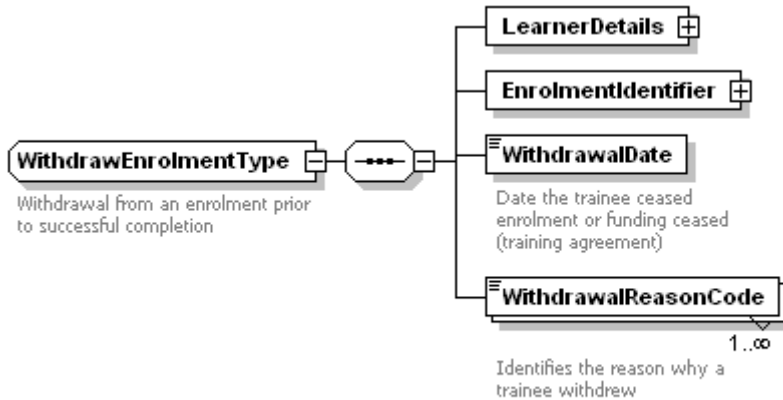

Generated with XMLSpy Schema Editor www.altova.com

The table below describes each of the elements in more detail:

Element name	Cardinality	Data type	Description
LearnerDetails	1	Complex	See section 4.2 for details.
WithdrawEnrolment	1	Complex	The enrolment to be withdrawn.
EnrolmentIdentifier	1	Complex	The unique identifier of the enrolment.
LocalIdentifier	1	Identifier Type	A unique identifier issued by the ITO TMS that identifies the specific enrolment the ITO wants to mark as complete. Validation: 1 Must match an enrolment for that ITO and learner.
ProgrammeCourse Identifier	1	Complex	Identifies the programme the enrolment relates to. See section 4.3 for details on the structure of this element. Validation: 1 Must match the ProgrammeCourse the trainee is enrolled on as per the LocalIdentifier. 2 Enrolment status must not be "Completed" but may be "Active", "Hold", "Grace", "Pending", or "Withdrawn".

Element name	Cardinality	Data type	Description																																				
			3 If the trainee is enrolled in complex MA or NZA then the parent enrolment only must be withdrawn. ITR will not allow sub-programme enrolments to be withdrawn.																																				
WithdrawalDate	1	DateType	Date the withdrawal became effective. Validation: 1 WithdrawalDate > EnrolmentParticipationStartDate 2 WithdrawalDate <= Today 3 WithdrawalDate <= Current Withdrawal Date																																				
WithdrawalReason Code	1	CodeType	Identifies the reason why the trainee withdrew Validation: 1 Must be one of the values below: <table border="1" data-bbox="863 958 1439 2049"> <thead> <tr> <th>Value</th> <th>Description</th> </tr> </thead> <tbody> <tr> <td>BC</td> <td>Business closed</td> </tr> <tr> <td>BD</td> <td>Business downturn</td> </tr> <tr> <td>CC</td> <td>Change in career choice</td> </tr> <tr> <td>AP</td> <td>Changing from Industry Trainee to Apprentice</td> </tr> <tr> <td>CP</td> <td>Change of programme</td> </tr> <tr> <td>DC</td> <td>Deceased</td> </tr> <tr> <td>DS</td> <td>Dissatisfied with employer/industry</td> </tr> <tr> <td>DF</td> <td>transfer to DFSO</td> </tr> <tr> <td>EW</td> <td>Exiting the workforce</td> </tr> <tr> <td>LS</td> <td>Lack of employer support</td> </tr> <tr> <td>LA</td> <td>Length of apprenticeship</td> </tr> <tr> <td>LI</td> <td>Linked Enrolment</td> </tr> <tr> <td>NA</td> <td>transferring from MA to NZA funded programmes</td> </tr> <tr> <td>NF</td> <td>Non-payment of fee</td> </tr> <tr> <td>OT</td> <td>Other</td> </tr> <tr> <td>OD</td> <td>Over programme duration</td> </tr> <tr> <td>PC</td> <td>Parental commitment</td> </tr> </tbody> </table>	Value	Description	BC	Business closed	BD	Business downturn	CC	Change in career choice	AP	Changing from Industry Trainee to Apprentice	CP	Change of programme	DC	Deceased	DS	Dissatisfied with employer/industry	DF	transfer to DFSO	EW	Exiting the workforce	LS	Lack of employer support	LA	Length of apprenticeship	LI	Linked Enrolment	NA	transferring from MA to NZA funded programmes	NF	Non-payment of fee	OT	Other	OD	Over programme duration	PC	Parental commitment
Value	Description																																						
BC	Business closed																																						
BD	Business downturn																																						
CC	Change in career choice																																						
AP	Changing from Industry Trainee to Apprentice																																						
CP	Change of programme																																						
DC	Deceased																																						
DS	Dissatisfied with employer/industry																																						
DF	transfer to DFSO																																						
EW	Exiting the workforce																																						
LS	Lack of employer support																																						
LA	Length of apprenticeship																																						
LI	Linked Enrolment																																						
NA	transferring from MA to NZA funded programmes																																						
NF	Non-payment of fee																																						
OT	Other																																						
OD	Over programme duration																																						
PC	Parental commitment																																						

Element name	Cardinality	Data type	Description	
			ST	Stop training (still with employer)
			TI	Transfer ITOs
			LE	Loss of employment
<p>Note: This will be validated at the schema level.</p>				

5.12.1 Validation flow diagram

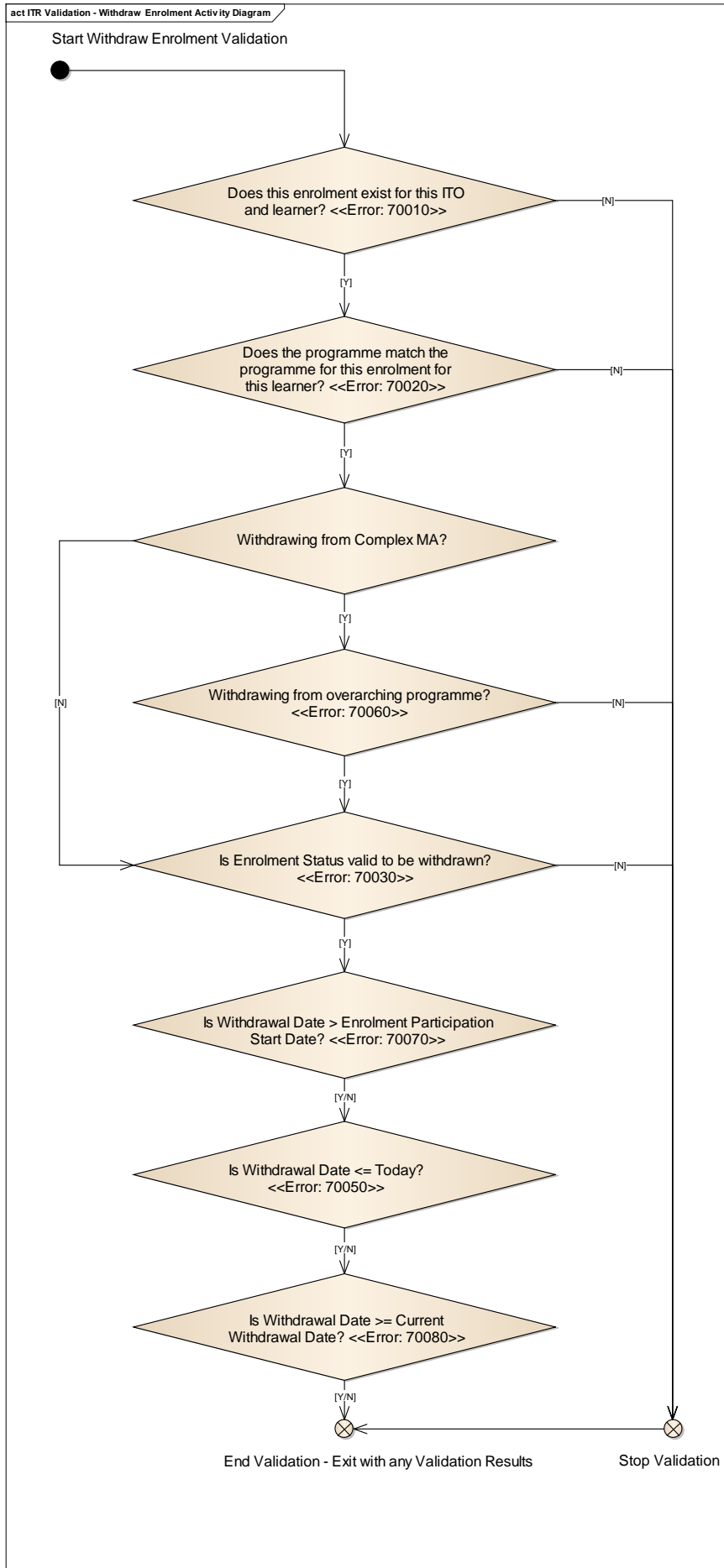

5.12.2 Business rules

The following business rules are applied if the Withdraw Enrolment details are valid:

ID	Rule Description
1	Create the withdraw enrolment event and associate it with the original enrolment. Note that for complex MA or NZA, a withdraw enrolment event is created for the overarching enrolment and each of the sub-programme enrolments.
2	<p>Updates to the enrolment:</p> <ul style="list-style-type: none">Change the status of the enrolment to "Withdrawn".Update the enrolment actual end date to the withdrawal date.ITR will create history records to capture these changes to the enrolments – refer to Section.7.7. <p>Note that for complex MA or NZA, the updates listed above apply to the overarching enrolment and each of the sub-programme enrolments.</p>

5.13 Update simple enrolment (E19)

In addition to being able to update Training Agreements, the ITR also allows ITOs to update simple enrolments. The Update Programme Enrolment message is used by ITOs to provide the ITR with a snapshot of the enrolment after the changes have been applied within the TMS.

The diagram below describes the elements required to update a simple enrolment.

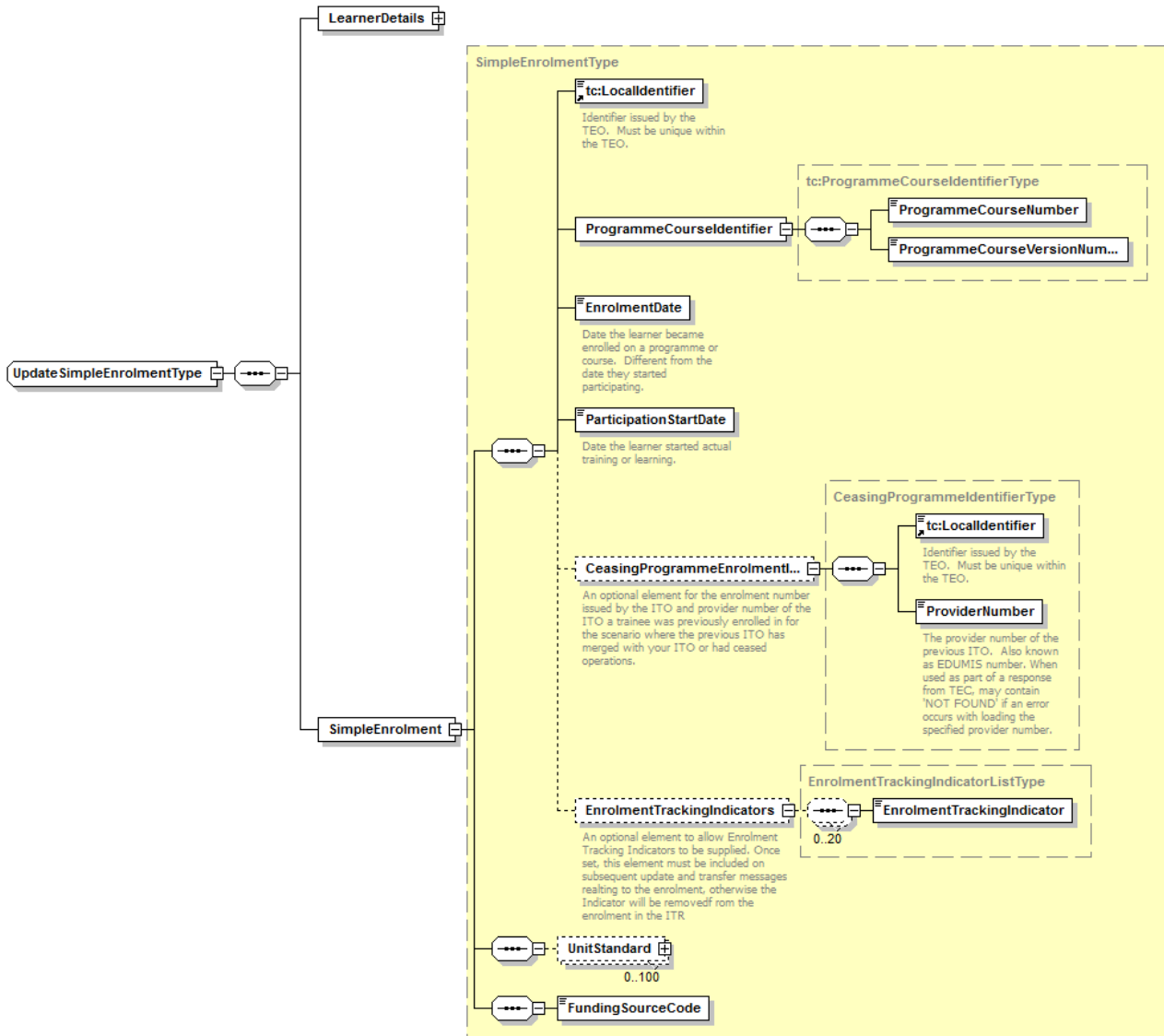

If an UpdateSimpleEnrolment message is submitted where the learner enrolment has been transferred previously, all participation start date validation rules will instead be applied against the latest Transfer Date. Latest Transfer Date is the date the enrolment was last transferred. See section 5.22 for more details of TransferSimpleProgrammeCourseVersion message.

The table below describes each element in more detail:

Element name	Cardinality	Data type	Description
LearnerDetails	1	Complex	See section 4.2 for a definition and base validation rules.
LocalIdentifier	1	Identifier Type	<p>A string that uniquely identifies the enrolment in a programme. Should be different from the training agreement LocalIdentifier.</p> <p>Validation:</p> <ol style="list-style-type: none"> 1 Must match an enrolment that belongs to the learner as identified in LearnerDetails and for the ITO that submitted the message. 2 The enrolment status must not be "Withdrawn" or "Completed". 3 Must not match an enrolment that is part of a Complex Modern Apprenticeship
ProgrammeCourse Identifier	1	Complex	<p>Identifies the Programme or Course the trainee is enrolled on.</p> <p>See section 5.5.4 for details.</p> <p>Validation:</p> <ol style="list-style-type: none"> 1 Must identify the same programme as that already held by the ITR for the LocalIdentifier supplied.
EnrolmentDate	1	DateType	<p>See section 5.5.4 for definition.</p> <p>Validation:</p> <ol style="list-style-type: none"> 1 EnrolmentDate >= original TrainingAgreementSignedDate <p>Note: This check needs to be done against the original TrainingAgreementSignedDate to allow for any Transfer Employer transactions that may have occurred. (A Transfer Employer results in the current training agreement being ended and a new training agreement being created with the new employer's details. Any enrolments associated with the old training agreement will be associated with the new training agreement.) For the addition or update of an enrolment we will validate the enrolment date against the original Training Agreement Signed Date not the current one.</p>

Element name	Cardinality	Data type	Description
ParticipationStartDate	1	DateType	<p>See section 5.5.4 for definition and base validation rules.</p> <p>Validation:</p> <ol style="list-style-type: none"> 1. Must match the ParticipationStartDate on the original enrolment. 2. If the ITO needs to change the ParticipationStartDate they will need to withdraw the enrolment and create a new enrolment.
UnitStandard	1..100	Complex	<p>See section 5.5.4 for definition.</p> <p>Validation:</p> <ol style="list-style-type: none"> 1 If a standard was listed in the current enrolment it must appear in the updated enrolment if it has been added to the trainee's RoA since the enrolment participation start date. <p>For all other units listed i.e. those not previously achieved, repeat validation rules 1, 2, 3, 4, 6, 7 and 8 in section 5.5.4.</p>
FundingSourceCode	1	Code Type	<p>See section 5.5.43 for definition.</p> <p>Validation:</p> <ol style="list-style-type: none"> 1 The FundingSourceCode must be the same as the FundingSourceCode on the original enrolment. If the ITO needs to change this they will need to withdraw the enrolment and re-enrol with the new FundingSourceCode, or use TransferSimpleEnrolment to transfer to a new version of the programme with a different FundingSourceCode
CeasingProgrammeEnrolmentIdentifier	0..1	Complex	<p>The enrolment details at the ceasing ITO</p> <p>See section 4.6 for details</p> <p>Additional Validation:</p> <p>The supplied enrolment ID must be valid</p> <p>The supplied enrolment must be for the same master NSN</p> <p>The programme version for this enrolment must be linked to the ceasing programme</p> <p>The participation start date of the new enrolment must be at least two days after the Participation Start Date of the ceasing enrolment</p>

Element name	Cardinality	Data type	Description
			<p>The supplied enrolment must not be in a COMPLETED state</p> <p>The supplied enrolment must not be previously linked to by any other enrolment</p> <p>If the relationship between the linked ITO's is Transfer of Coverage; The supplied enrolment must be WITHDRAWN</p>
EnrolmentTrackingIndicator	0..20	Complex	<p>See section 4.7 for details</p> <p>Supplied Enrolment Tracking Indicators must be valid</p>

5.13.1 Validation flow diagram

Validation of Simple Enrolments is made up of two parts:

1. Learner Details – Details about the learner are validated as described in section 4.2.

2. Simple enrolment validation.

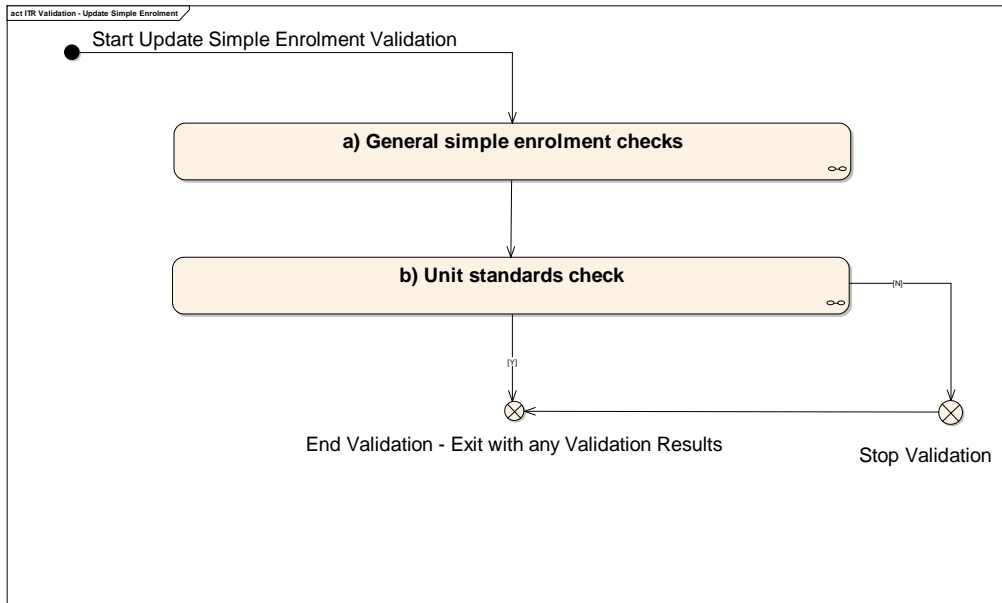

3. General checks

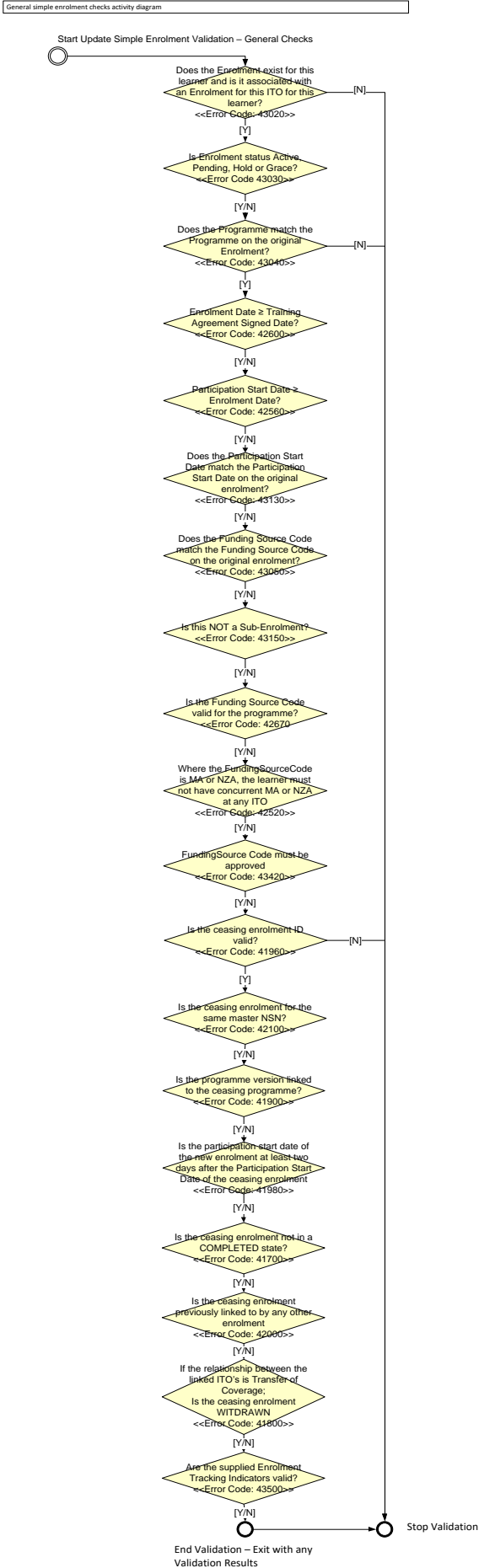

4. Unit standard checks

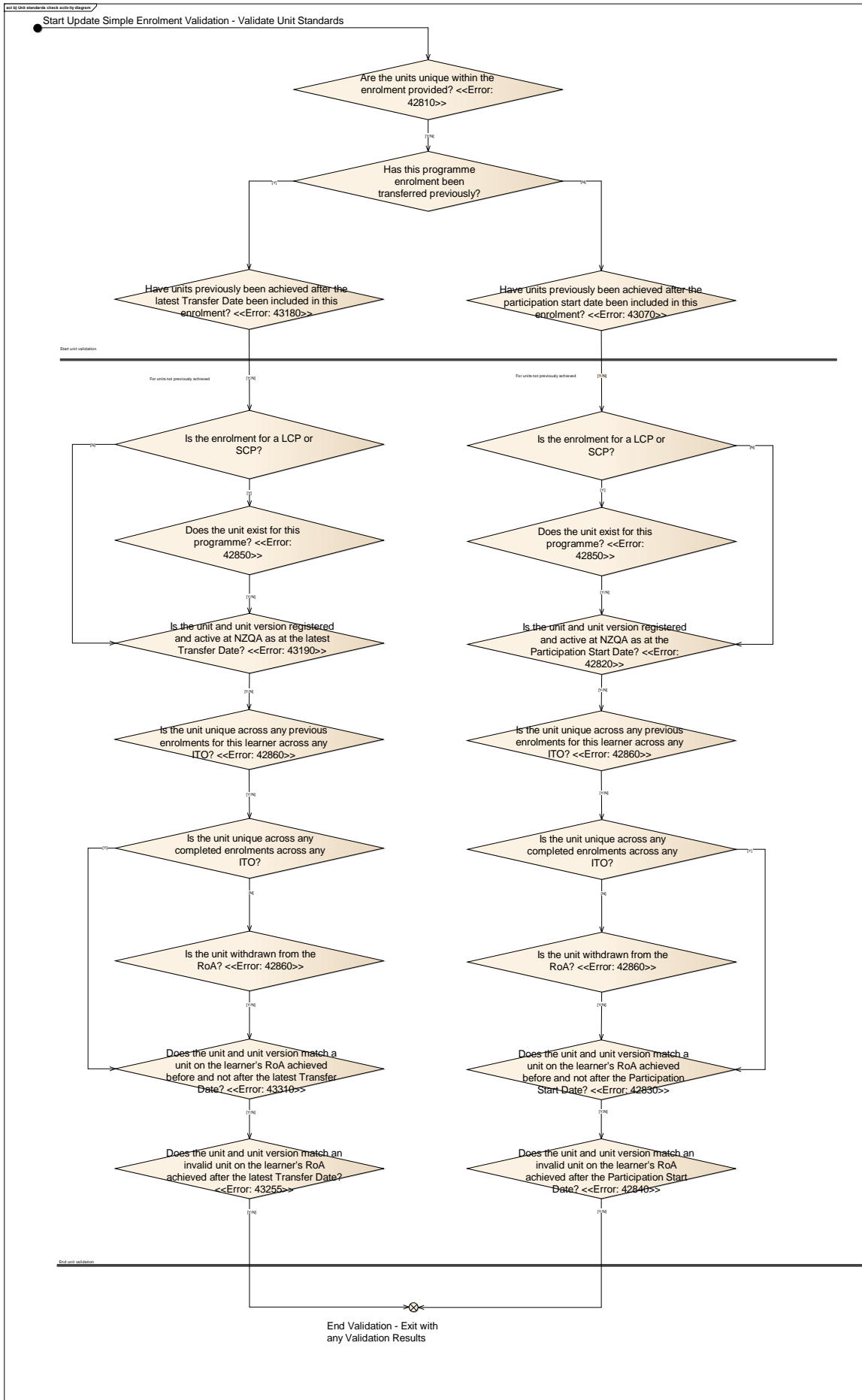

5.13.2 Business rules

The following business rules are applied if the Update Simple Enrolment details are valid:

ID	Rule Description
1	The following elements are updatable on the Update Simple Enrolment message: <ul style="list-style-type: none"><li data-bbox="363 371 616 405">• Enrolment Date<li data-bbox="363 432 592 465">• Unit Standard
2	<ul style="list-style-type: none"><li data-bbox="363 495 1398 528">• ITR will create history records to capture the changes – refer to Section.7.7.<li data-bbox="363 555 1319 638">• On the original simple enrolment learner event:<ul style="list-style-type: none"><li data-bbox="459 611 1319 638">○ Update Event Reported Date to the message processing date.

Update complex MA or NZA programme enrolment (E19)

In addition to being able to update simple enrolments, the ITR also allows ITOs to update complex modern apprenticeship enrolments. The Update Programme Enrolment message is used by ITOs to provide the ITR with a snapshot of the enrolment after the changes have been applied within the TMS.

The diagram below describes the elements required to update a complex modern apprenticeship enrolment.

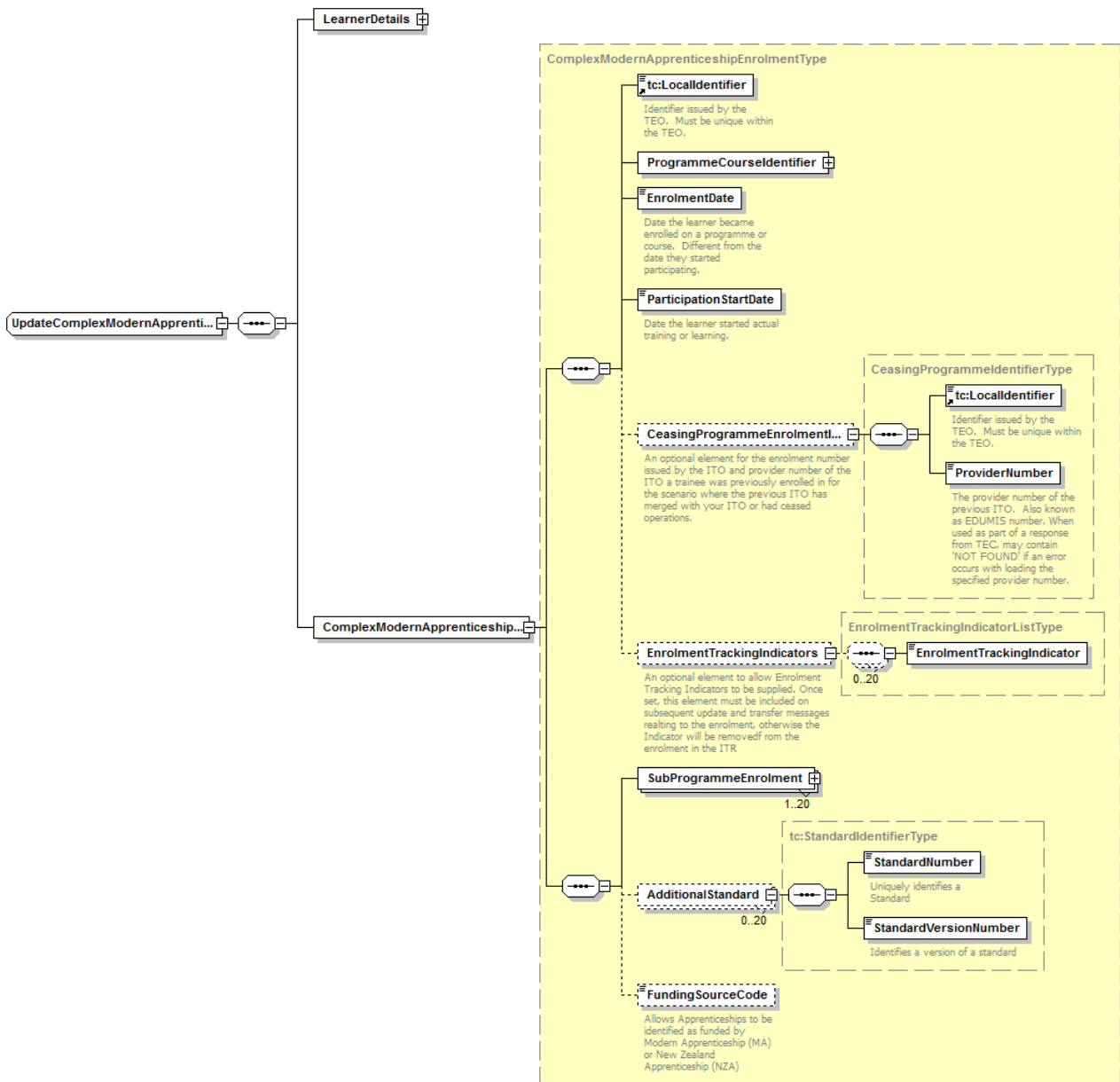

Generated with XMLSpy Schema Editor www.altova.com

If an UpdateComplexModernApprenticeshipEnrolment message is submitted where the learner enrolment has been transferred previously, then:

- a. All participation start date validation rules will instead be applied against the last Transferred Date. See section 5.23 for more details of TransferComplexModernApprenticeship-ProgrammeCourseVersion.
- b. Where the learner has a single sub-programme enrolment to be completed, the ITR will allow an UpdateComplexModernApprenticeshipEnrolment message in a single sub-programme enrolment. It will be optional to provide at least one unit standard where the learner has completed all the additional unit standards [and/or] a sub-programme enrolment before the latest transfer date.

The table below describes the elements in more detail:

Element name	Cardinality	Data type	Description
LearnerDetails	1	Complex	See section 4.2 for a definition and base validation rules.

Element name	Cardinality	Data type	Description
LocalIdentifier	1	Identifier Type	<p>A string that uniquely identifies the enrolment in a programme. Should be different from the training agreement LocalIdentifier.</p> <p>Validation:</p> <ol style="list-style-type: none"> 1 Must match an enrolment that belongs to the learner as identified in LearnerDetails and for the ITO that submitted the message. 2 Must be for the overarching programme enrolment. 3 The enrolment status must not be "Withdrawn" or "Completed".
ProgrammeCourse Identifier	1	Complex	<p>Identifies the Programme or Course the trainee is enrolled on.</p> <p>See section 5.5.7 for details.</p> <p>Validation:</p> <ol style="list-style-type: none"> 1 Must identify the same programme as that already held by ITR for the LocalIdentifier supplied.
EnrolmentDate	1	DateType	<p>See section 5.5.7 for definition.</p> <p>Validation:</p> <ol style="list-style-type: none"> 1 EnrolmentDate >= original TrainingAgreementSignedDate <p>Note: This check needs to be done against the original TrainingAgreementSignedDate to allow for any Transfer Employer transactions that may have occurred. (A Transfer Employer results in the current training agreement being ended and a new training agreement being created with the new employer's details. Any enrolments associated with the old training agreement will be associated with the new training agreement.) For the addition or update of an enrolment we will validate the enrolment date against the original Training Agreement Signed Date not the current one.</p>
ParticipationStart Date	1	DateType	<p>See section 5.5.7 for definition and base validation rules.</p> <p>Validation:</p>

Element name	Cardinality	Data type	Description
			<p>1 Must match the ParticipationStartDate on the original enrolment.</p> <p>If the ITO needs to change the ParticipationStartDate they will need to withdraw the enrolment and create a new enrolment.</p>
SubProgramme Enrolment	1..20	Complex	<p>Details about the sub-programme enrolments contained within the complex MA or NZA enrolment.</p> <p>See section 5.5.7 for definition and base validation rules.</p> <p>Validation:</p> <p>Apply the validation rules described in section 5.5.7, plus the following:</p> <ol style="list-style-type: none"> 1 Cannot remove an existing SubProgrammeEnrolment i.e. all sub-programme enrolments on the original enrolment must be included on the updated enrolment. 2 If a sub-programme has been added, validate that the sub-programme is registered for that Complex MA or NZA (see section 5.2.7). This means that the sub-programme is listed against that MA or NZA. 3 Apply the validation rules specified for updating simple enrolments (section 5.13). <p>Note: ITR will not update any sub-programme enrolment that has a status of "Completed".</p>
AdditionalStandard	0..20	Complex	<p>See section 5.5.7 for definition and base validation rules.</p> <p>Validation:</p> <p>Validate as per section 5.5.7 plus the following:</p> <ol style="list-style-type: none"> 1 If a standard was listed in the current enrolment it must appear in the updated enrolment if it has been added to the trainee's RoA since the enrolment participation start date.
FundingSourceCode	0..1	CodeType	<p>See Section 5.5.7 for further information</p> <p>Validation:</p>

Element name	Cardinality	Data type	Description
			<p>1 The FundingSourceCode must be the same as the FundingSourceCode on the original enrolment. i.e. if the original enrolment is NZA, then NZA must be supplied on Update.</p> <p>If the ITO needs to change this they will need to withdraw the enrolment and re-enrol with the new FundingSourceCode, or use TransferComplexModernApprenticeshipEnrolment to transfer to a new version of the programme with a different FundingSourceCode</p>
CeasingProgrammeEnrolmentIdentifier	0..1	Complex	<p>The enrolment details at the ceasing ITO</p> <p>See section 4.6 for details</p> <p>Additional Validation:</p> <p>The supplied enrolment ID must be valid</p> <p>The supplied enrolment must be for the same master NSN</p> <p>The programme version for this enrolment must be linked to the ceasing programme</p> <p>The participation start date of the new enrolment must be at least two days after the Participation Start Date of the ceasing enrolment</p> <p>The supplied enrolment must not be in a COMPLETED state</p> <p>The supplied enrolment must not be previously linked to by any other enrolment</p> <p>If the relationship between the linked ITO's is Transfer of Coverage; The supplied enrolment must be WITHDRAWN</p>
EnrolmentTrackingIndicator	0..20	Complex	<p>See section 4.7 for details</p> <p>Supplied Enrolment Tracking Indicators must be valid</p>

5.14.1 Validation flow diagram

Validation of Updating Complex MA or NZA Enrolments is made up of three parts:

1. Learner Details – Details about the learner are validated as described in section 4.2.
2. Training Agreement – Rules relating to valid Training Agreement as described in section 5.5.
3. Complex Modern Apprenticeships validation – Rules relating to Complex Modern Apprenticeships and New Zealand Apprenticeships performed as per the diagram below:

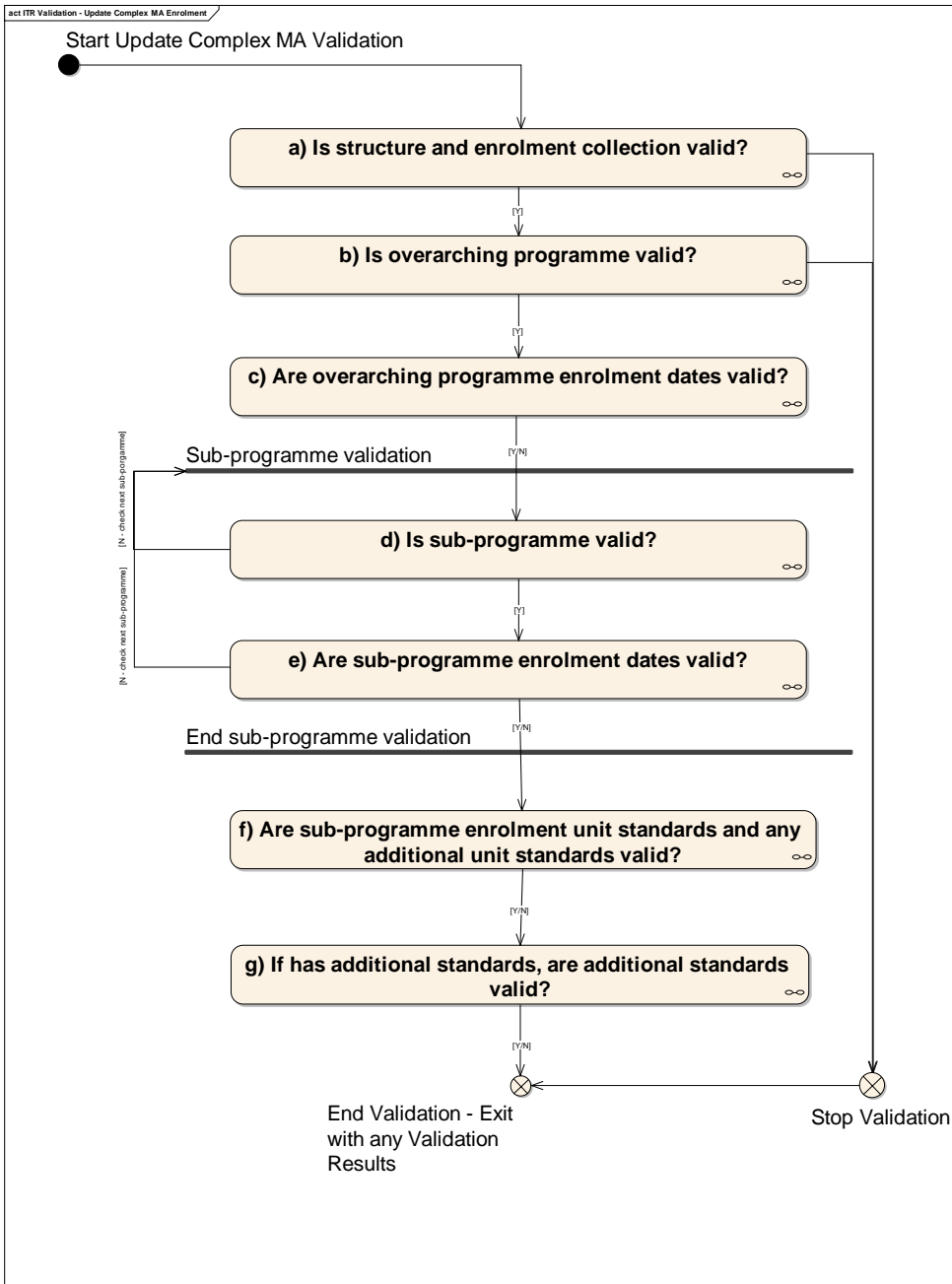

a. Is structure and enrolment collection valid?

Is structure and enrolment collection valid activity diagram

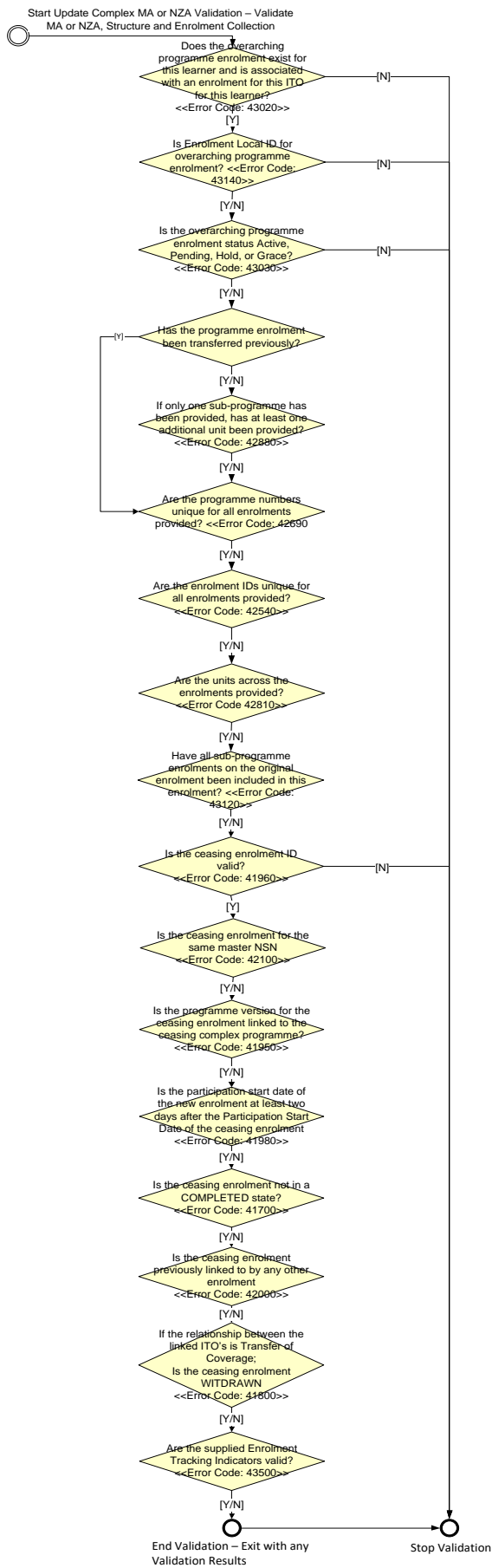

Is overarching programme validation valid?

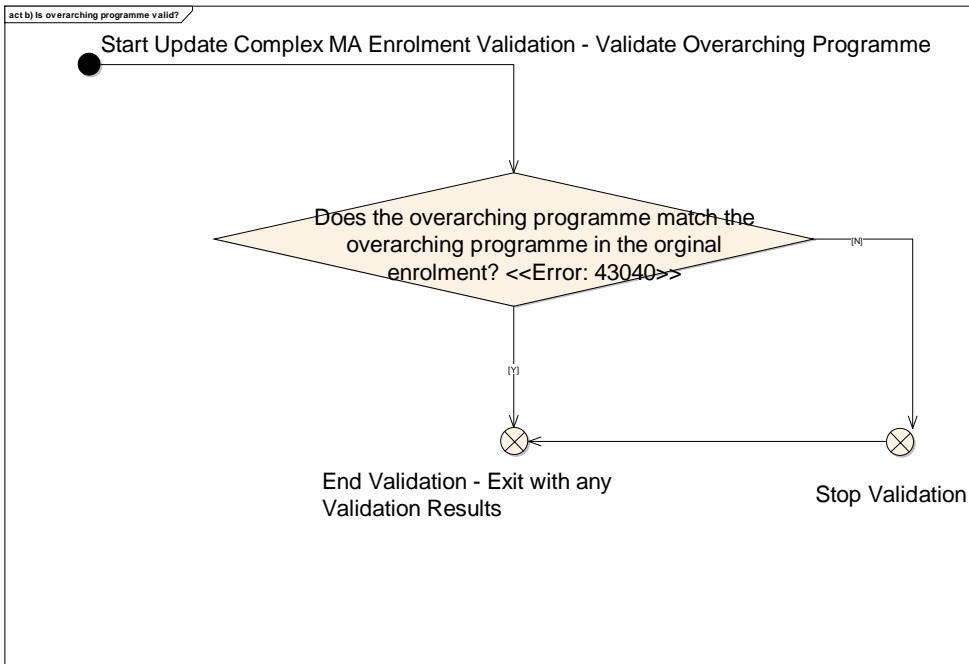

b. Are overarching programme enrolment dates valid?

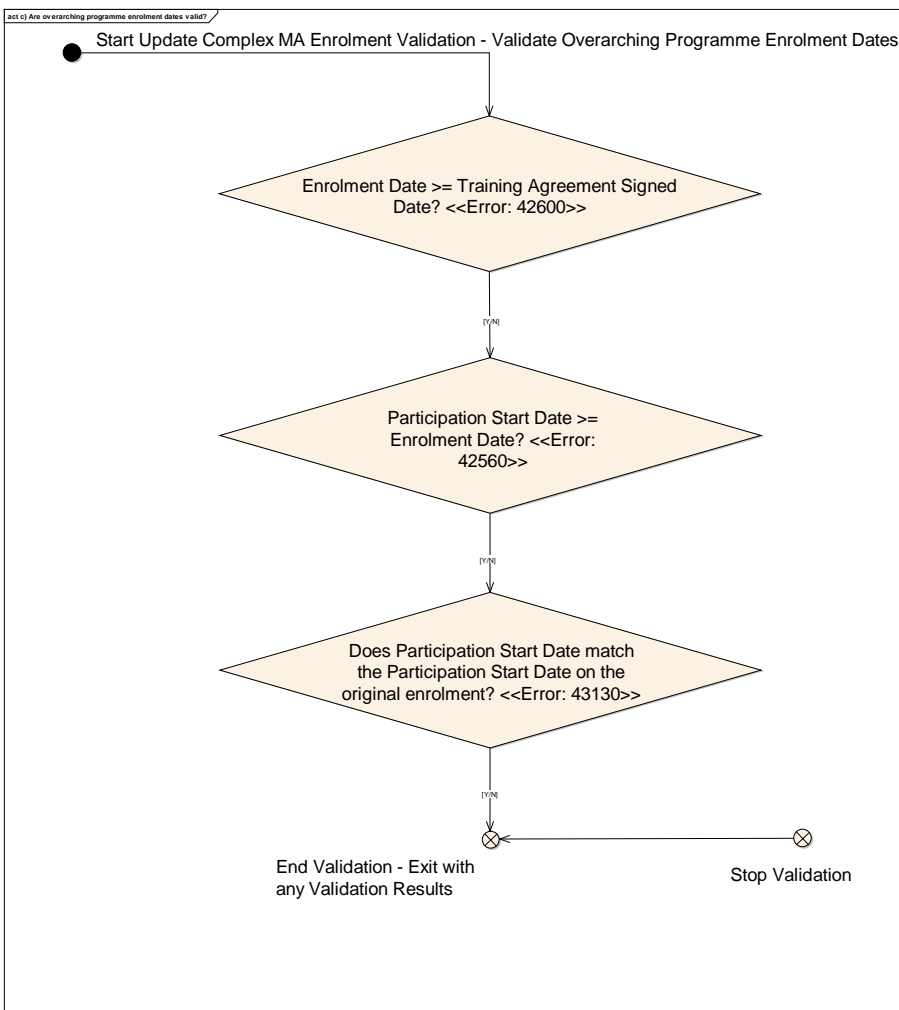

c. Is sub-programme valid?

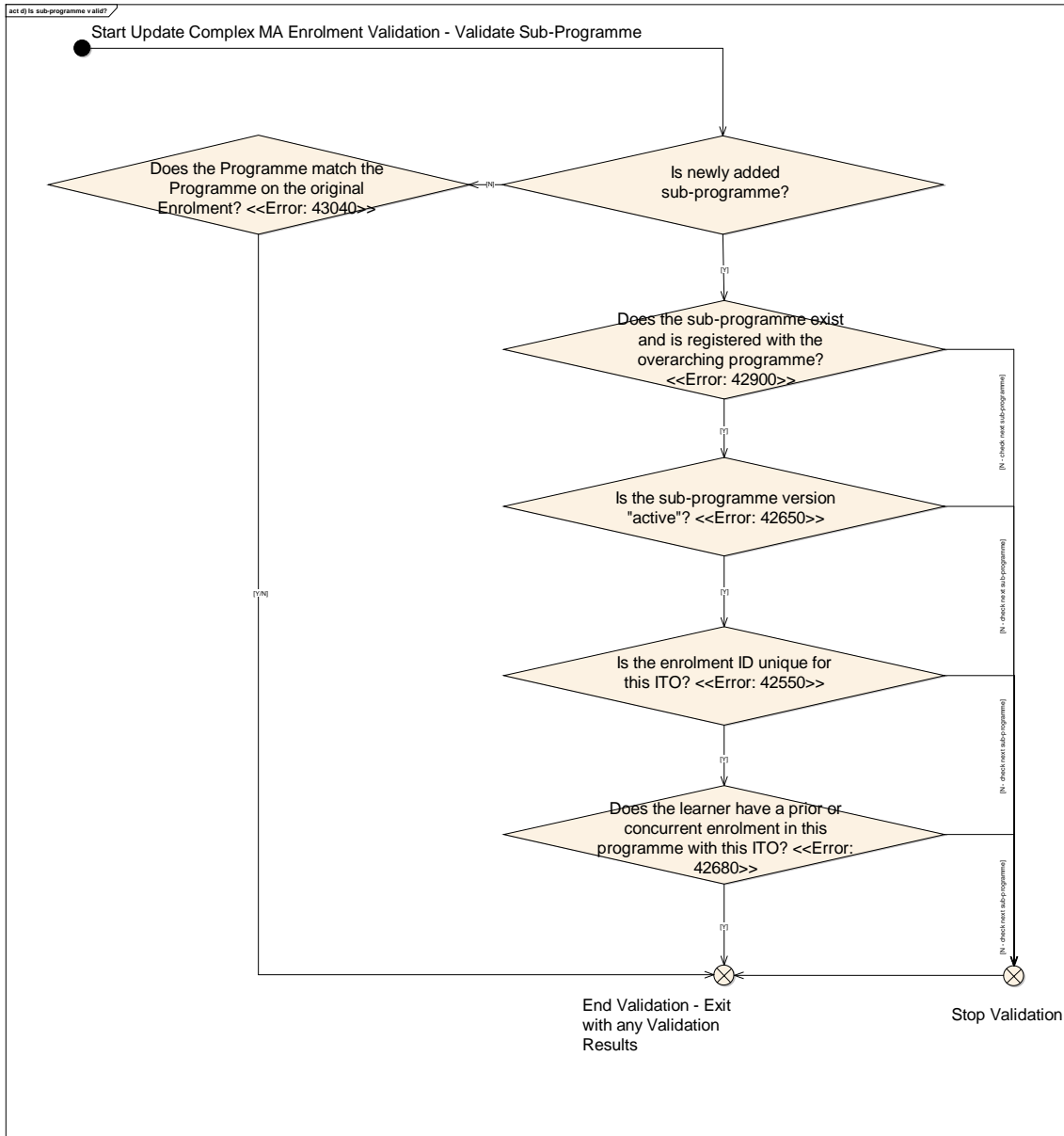

d. Are sub-programme enrolment dates valid?

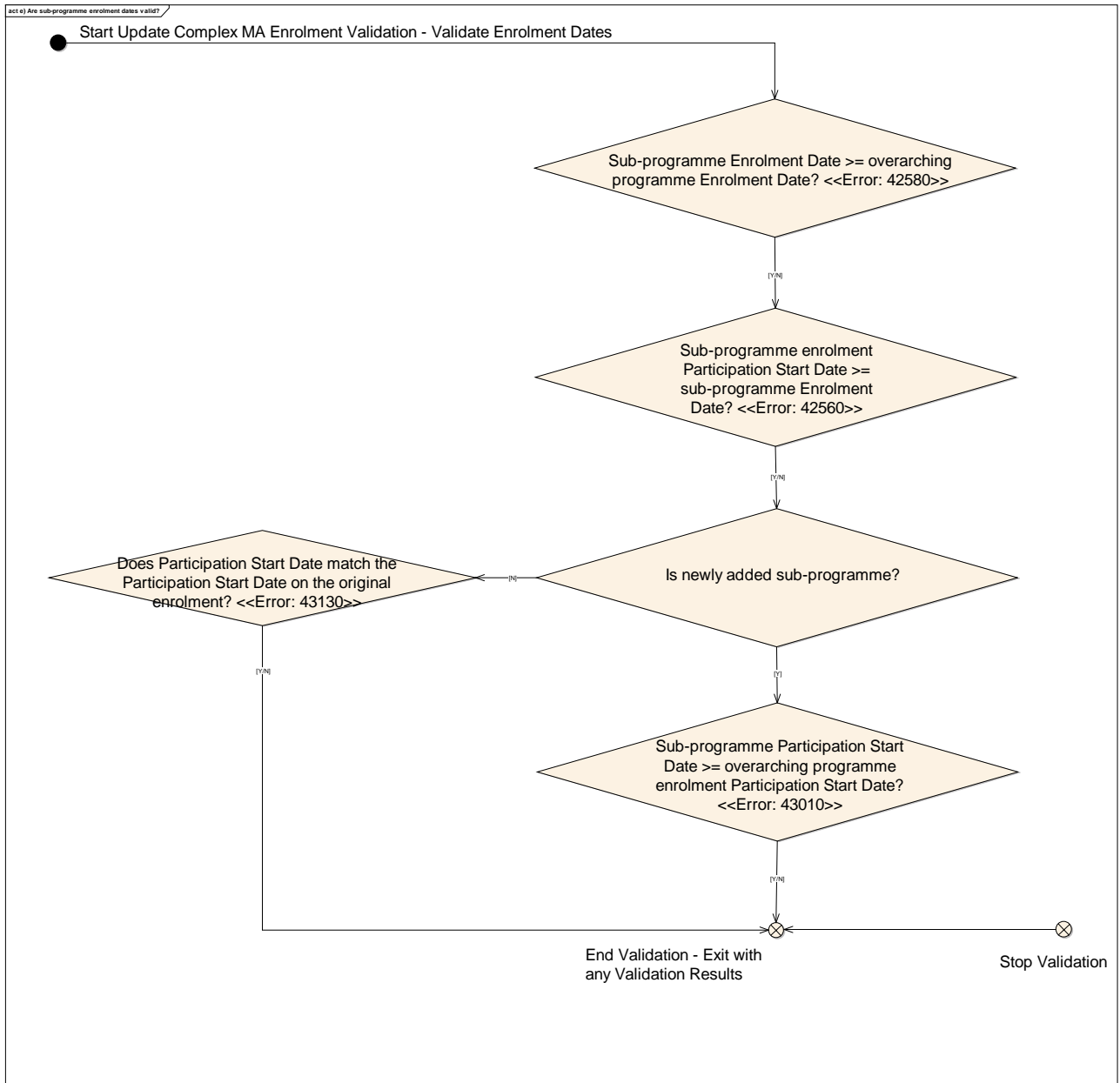

e. Are sub-programme enrolment unit standards and any additional unit standards valid?

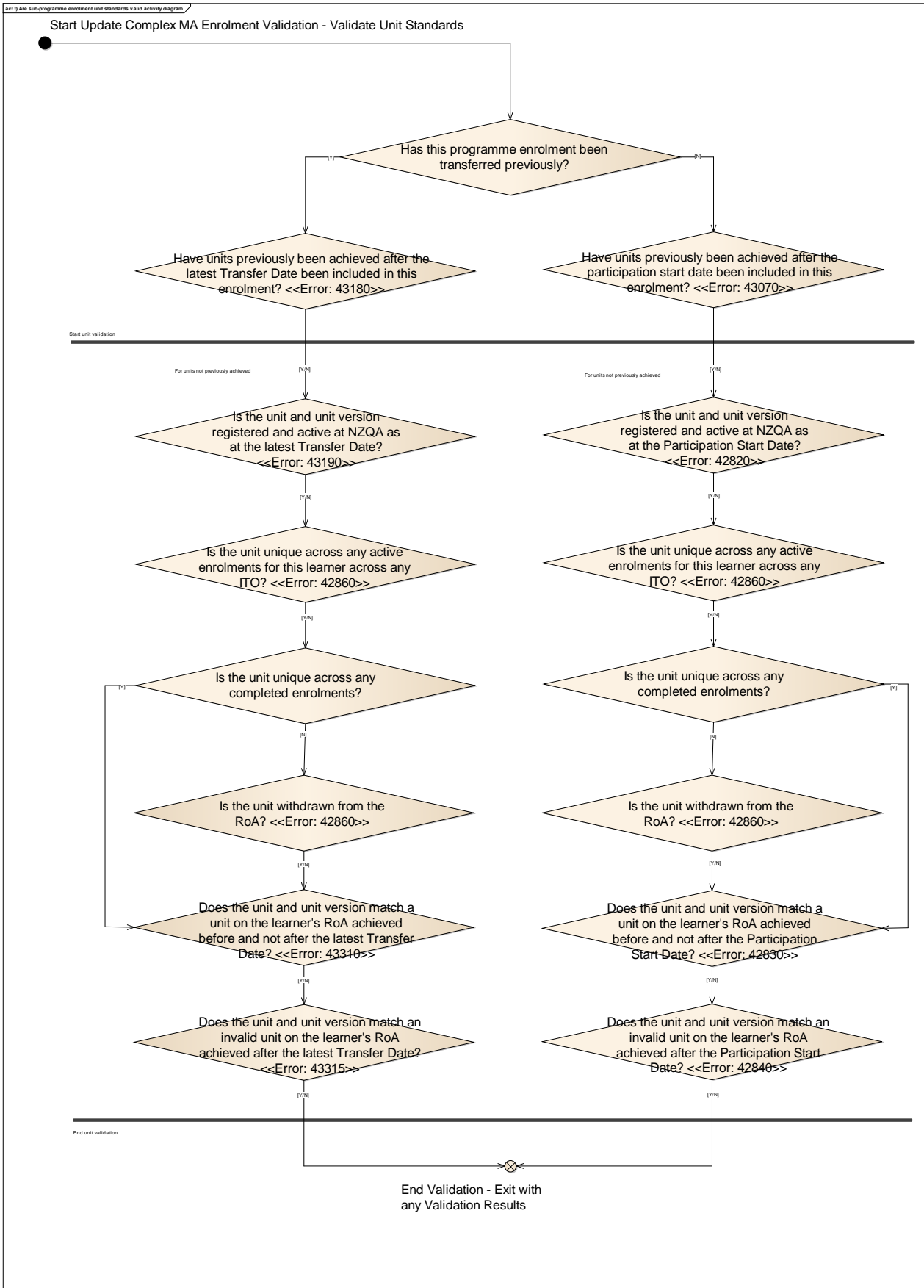

f. Are additional standards valid?

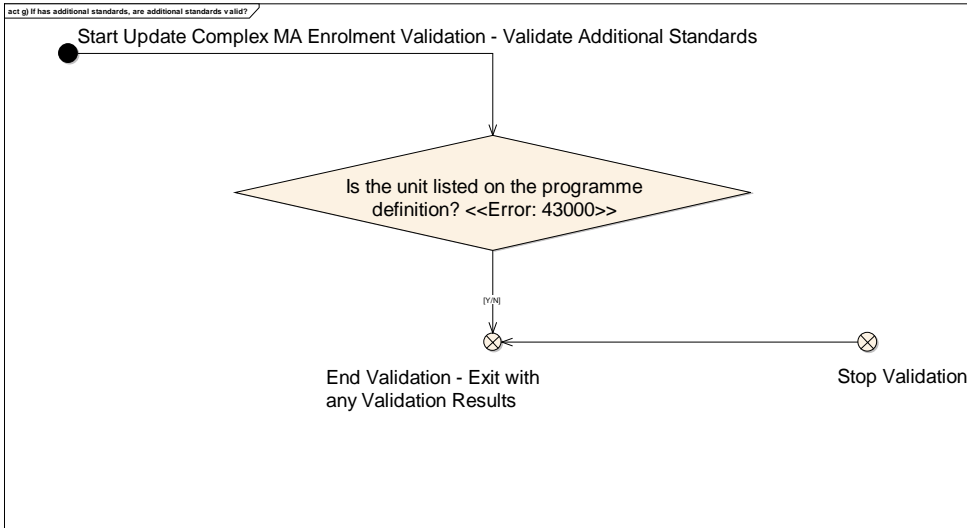

5.14.2 Business rules

The following business rules are applied if the Update Complex MA or NZA Programme Enrolment details are valid:

ID	Rule Description
1	<p>The following elements are updatable on the Update Complex MA or NZA Enrolment message:</p> <ul style="list-style-type: none"> • (overarching programme) Enrolment Date • (sub-programme) Enrolment Date • (sub-programme) Unit Standard • Additional Standard
2	<ul style="list-style-type: none"> • ITR will create history records to capture the changes – refer to Section.7.7. • On the original complex MA or NZA enrolment learner event: <ul style="list-style-type: none"> ○ Update Event Reported Date to the message processing date.

5.15 Add enrolment (E20)

The Add Enrolment message allows an ITO to add a simple IT or TA enrolment to an existing, active, Training Agreement. The enrolment to be added will have an enrolment status that is the same status as the Training Agreement. The Add Enrolment message cannot be used to add enrolments to Modern Apprenticeships as a modern apprentice can only be enrolled in one modern apprenticeship programme at a time.

The diagram below describes the elements that make up an Add Enrolment message:

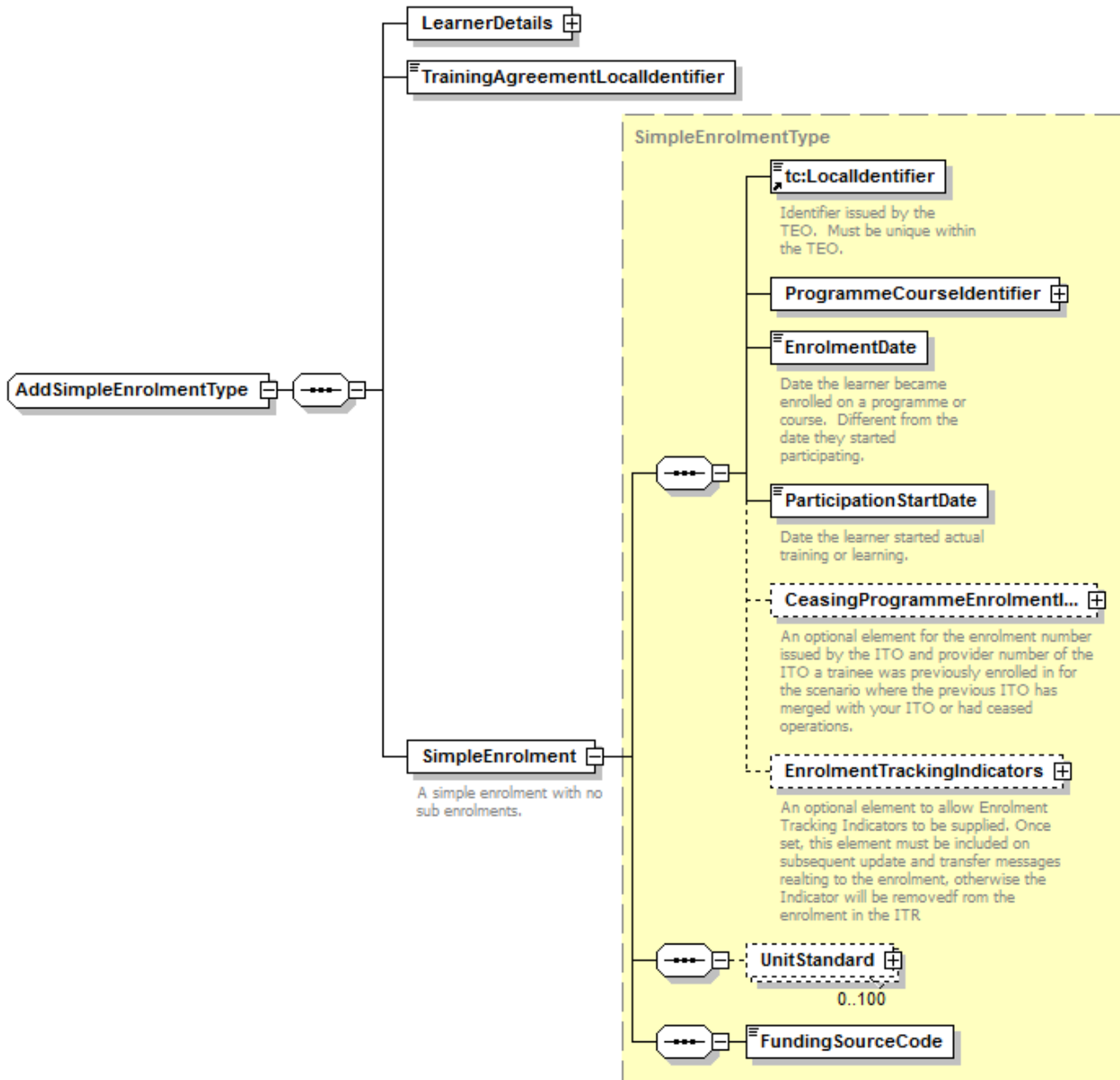

Generated with XMLSpy Schema Editor www.altova.com

The table below describes the elements of the Add Enrolment message in more detail:

Element name	Cardinality	Data type	Description
LearnerDetails	1	Complex	See section 4.2 for a definition and base validation rules.
TrainingAgreement LocalIdentifier	1	Identifier Type	Identifies the training agreement that the enrolment should be added to. Validation:

Element name	Cardinality	Data type	Description
			<p>1 Must match a training agreement that belongs to the learner as identified in LearnerDetails and for the ITO that submitted the message.</p> <p>2 The training agreement status must not be "Finished".</p>
Programme Enrolment	1	Complex	<p>Describes the new enrolment to be added to the training agreement. Please refer to section 5.5.4 for details.</p> <p>Validation:</p> <p>Validate using the rules defined in section 5.5.4 as follows:</p> <ul style="list-style-type: none"> • LocalIdentifier validation rule 1. • ProgrammeCourseIdentifier validation rules 1, 2, 3 and 4. • ParticipationStartDate validation rule 1. • UnitStandard validation rules 1, 2, 3, 4, 6, 7 and 8. • FundingSourceCode validation rules 1, 3 and 4. <p>In addition to the above, validate the new rules below.</p> <p>Validation:</p> <p>1 EnrolmentDate >= original TrainingAgreementSignedDate</p> <p>Note: This check needs to be done against the original TrainingAgreementSignedDate to allow for any Transfer Employer transactions that may have occurred. (A Transfer Employer results in the current training agreement being ended and a new training agreement being created with the new employer's details. Any enrolments associated with the old training agreement will be associated with the new training agreement.) For the addition or update of an enrolment we will validate the enrolment date against the original Training Agreement Signed Date not the current one.</p> <p>2 For Linked Programme Enrolment:</p> <p>If a linked enrolment is supplied, the programme being linked to must have</p>

Element name	Cardinality	Data type	Description
			already been linked to the programme that the learner is being enrolled in.
FundingSourceCode	0..1	CodeType	See section 5.2.3 for details
CeasingProgramme EnrolmentIdentifier	0..1	Complex	See section 4.6 for details The Ceasing Programme Enrolment Identifier is not supported for this message. Do not supply data in this field for this message.
EnrolmentTrackingIndicator	0..20	Complex	See section 4.7 for details Supplied Enrolment Tracking Indicators must be valid

5.15.1 Validation flow diagram

Validation of Simple Enrolments is made up of two parts:

1. Learner Details – Details about the learner are validated as described in section 4.2.
2. Add enrolment validation.

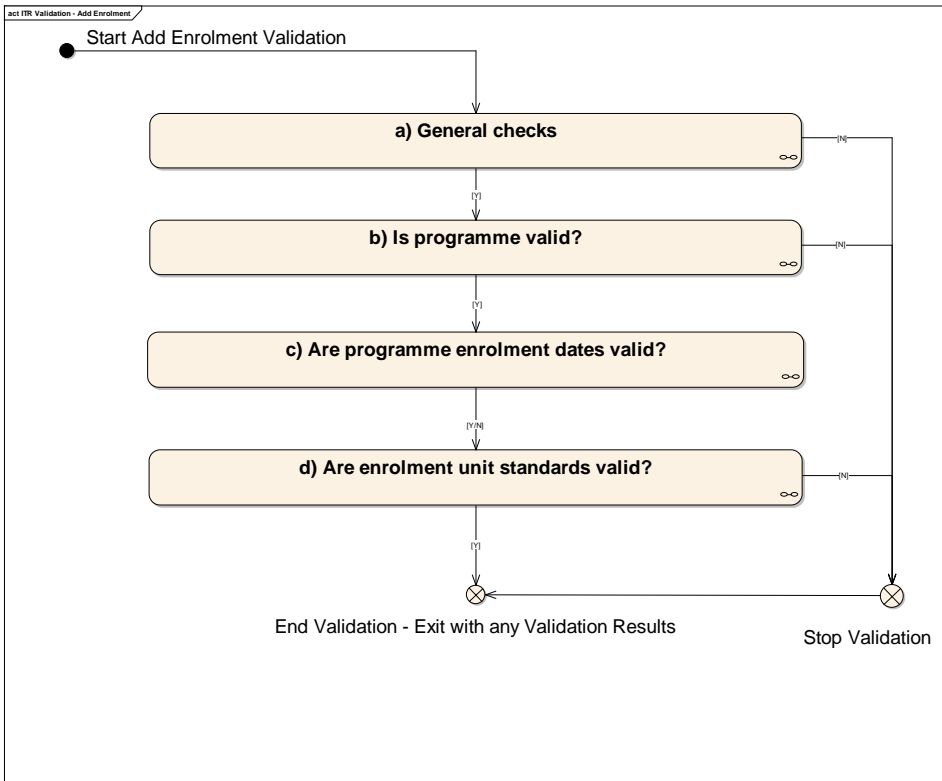

3. General checks

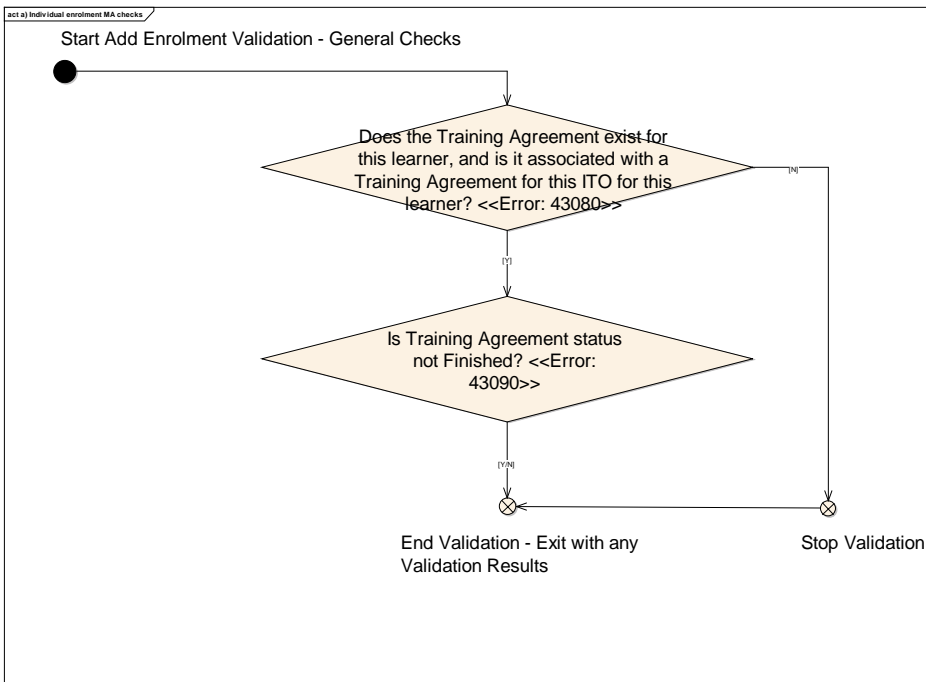

a. Is programme valid?

Is Structure and Enrolment Collection Valid activity diagram

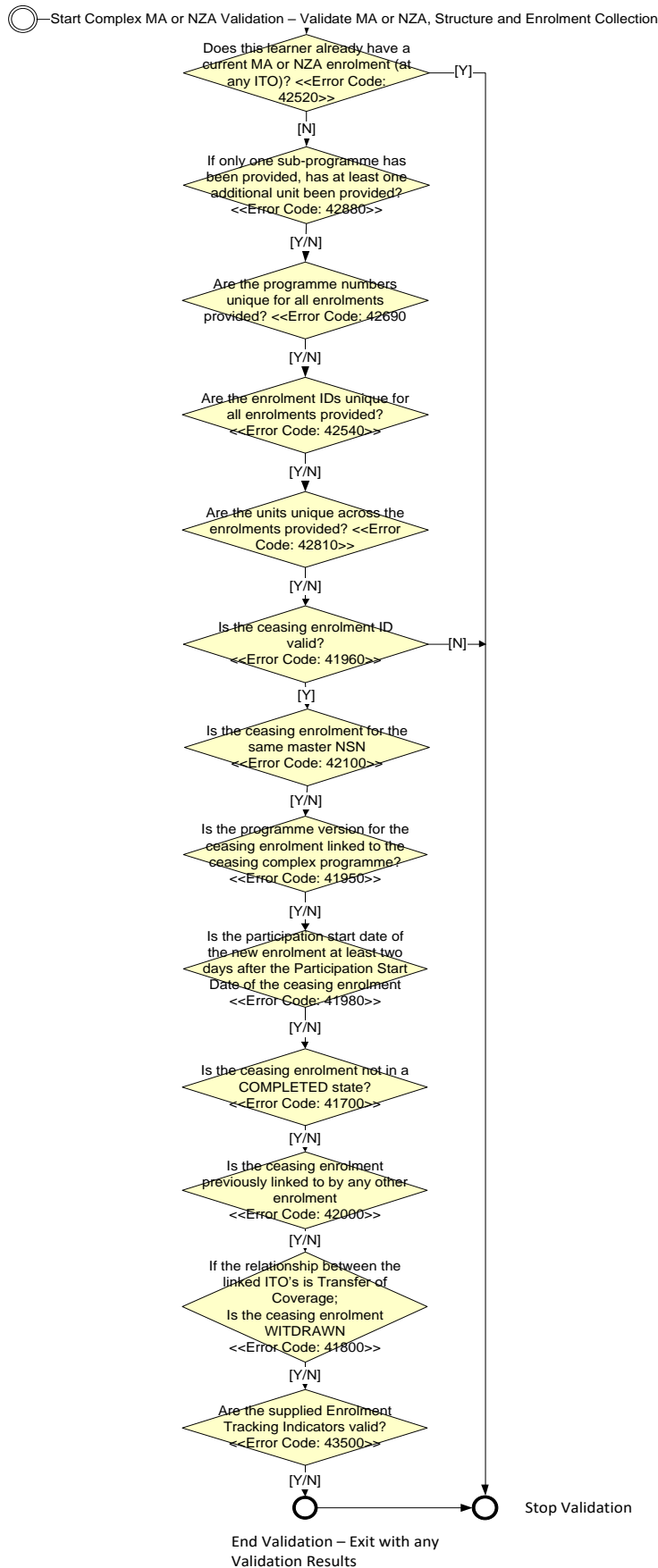

b. Are programme enrolment dates valid?

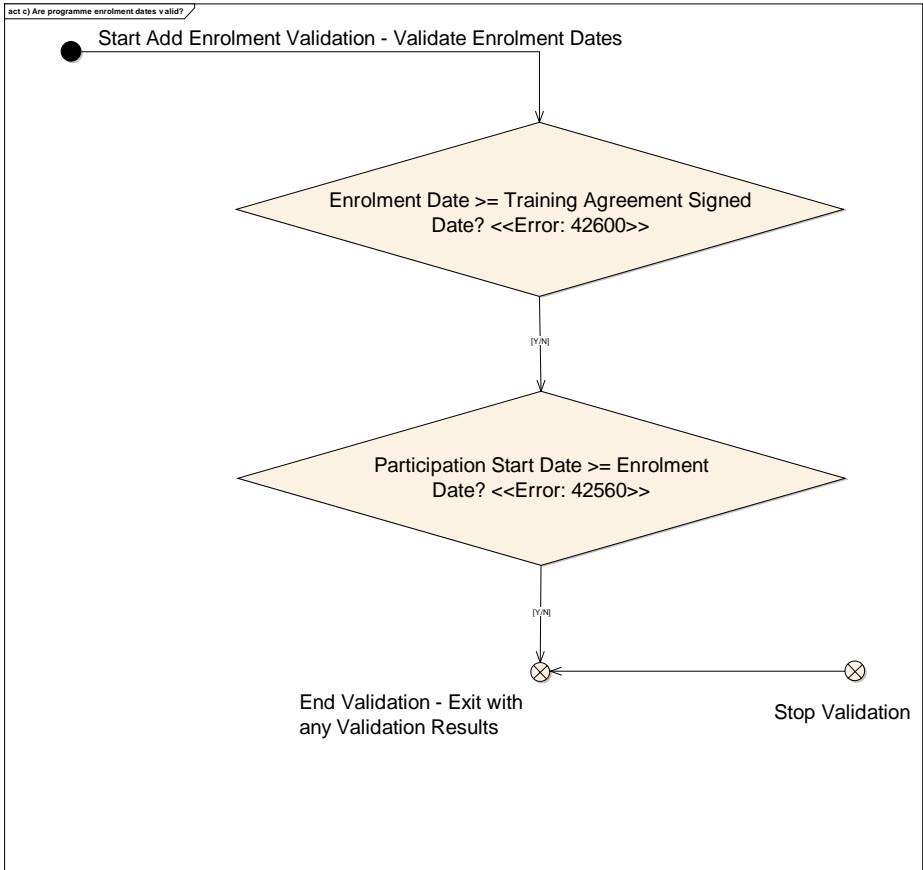

c. Are enrolment unit standards valid?

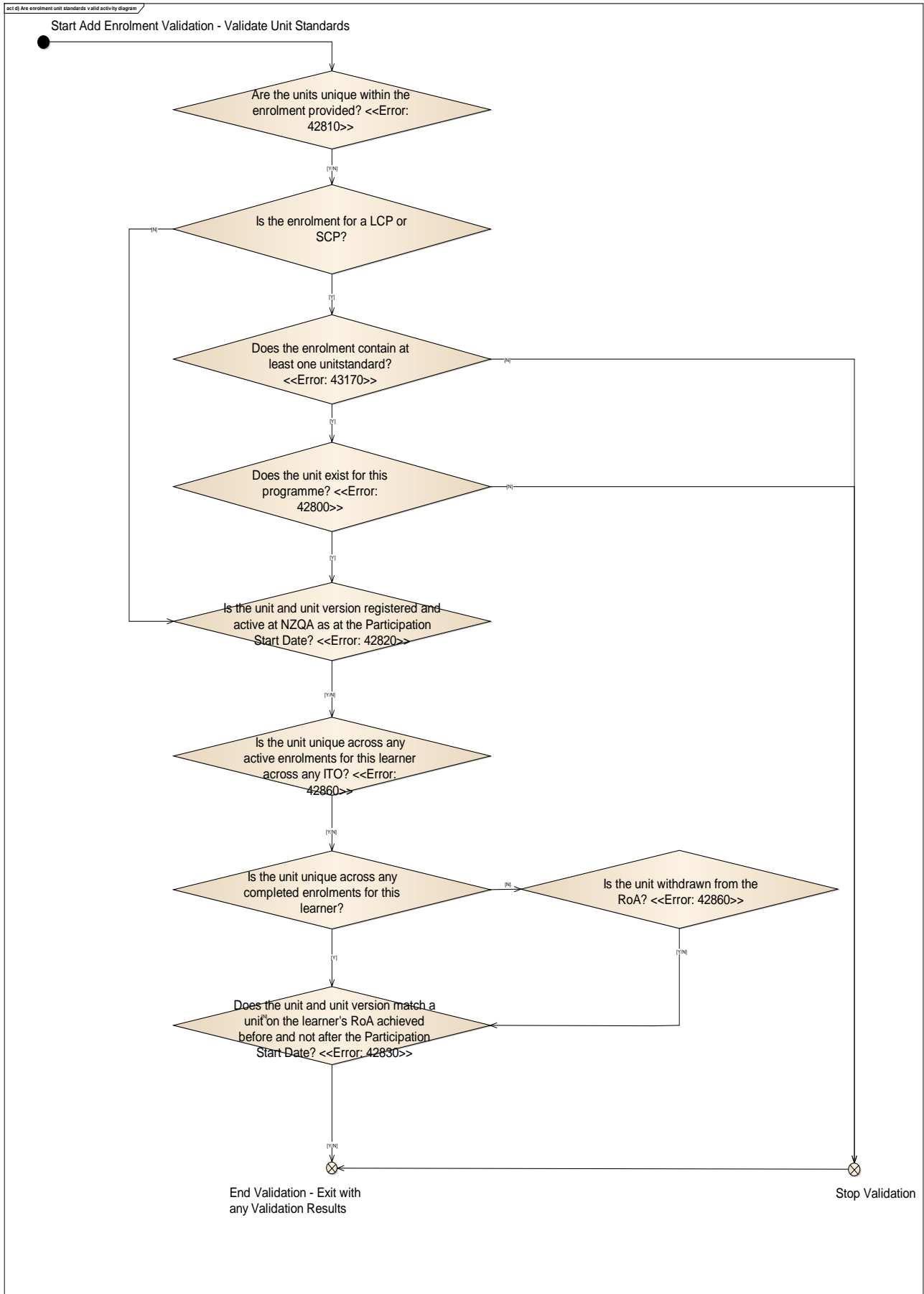

5.15.2 Business rules

The following business rules are applied if the Add Enrolment details are valid:

ID	Rule description
1	ITR will create history records to capture the changes – refer to Section.7.7.

5.16 Create MA or NZA training plan (E22)

Modern apprentices must have a Training Plan to be eligible for TEC funding. An MA or NZA training plan represents the agreement between the apprentice, employer and MAC on the additional support the MAC will provide during the apprenticeship. An MA or NZA Training Plan is tightly linked to a training agreement which represents an agreement between the apprentice, employer and ITO.

ITOs must inform TEC when an MA or NZA training plan is created before the apprenticeship is eligible for TEC funding.

IMPORTANT: ITOs do not need to report a training plan for industry trainees.

MA or NZA Training Plans must be created after the related training agreement. Once an MA or NZA Training Plan has been successfully created, the ITR will:

1. Set the enrolment participation start date on all enrolments linked to the Training Agreement that are “Pending”, “Hold”, “Grace” (i.e. not “Completed” or “Withdrawn”) unless this date is already greater than the TrainingPlanSignedDate. The enrolments start accruing STMs from this point.
2. For each enrolment where the participation start date is being updated, check that the programme is active as at the Training Plan signed date
3. For each Pending enrolment on the training agreement, change the enrolment status to “Active”.
4. If the Training Agreement status is “Pending”, then update it to “Active”.

The following diagram represents the elements required to create an MA or NZA training plan.

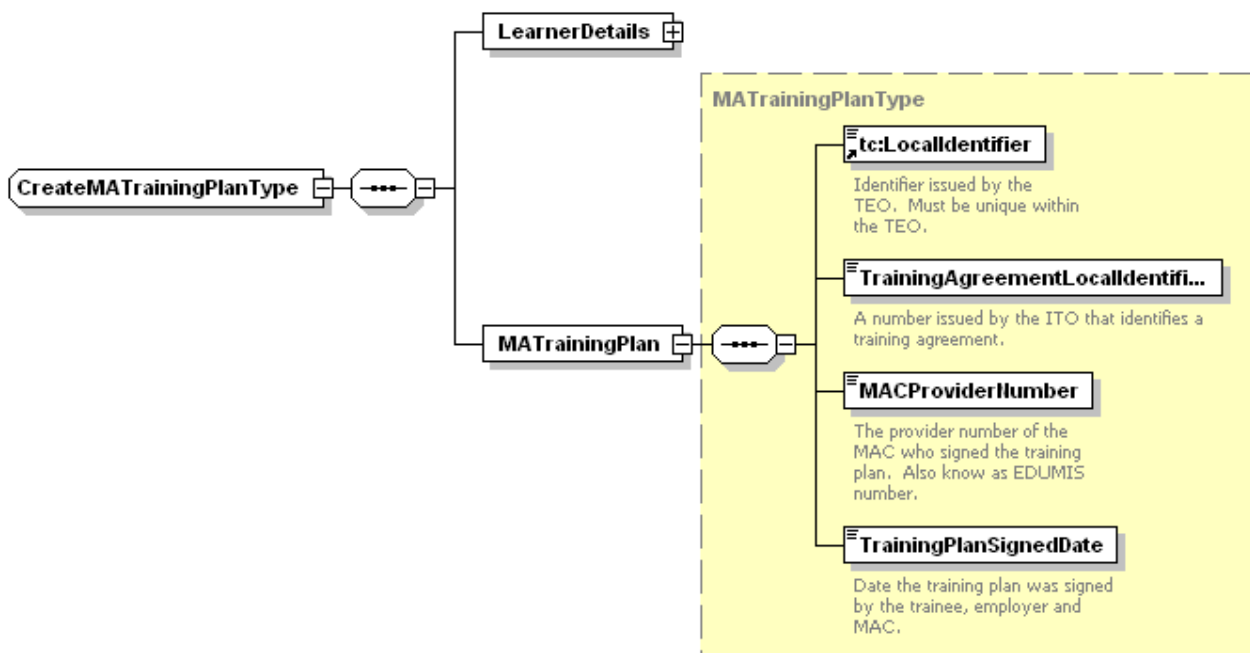

Generated with XMLSpy Schema Editor www.altova.com

The table below describes the elements required to create a training plan in more detail.

Element name	Cardinality	Data type	Description
LearnerDetails	1	Complex	Common learner information supplied with all messages. See section 4.2 for details.
MATrainingPlan	1	Complex	Details about the training plan
LocalIdentifier	1	Identifier Type	A unique number issued by the ITO that identifies the MA or NZA Training Plan. Validation: <ol style="list-style-type: none"> 1 Must be unique for the ITO. 2 Must be the only training plan for the associated training agreement.
TrainingAgreement LocalIdentifier	1	Identifier Type	Identifies the training agreement that the MA or NZA Training Plan relates. Validation: <ol style="list-style-type: none"> 1 Training agreement referenced must exist for the same apprentice for the same ITO. 2 Training agreement status must be "Pending", "Hold" or "Grace" (i.e. not "Active" or "Finished") 3 Enrolments attached to the training agreement must have a funding source of "MA" (modern apprenticeship) or NZA (New Zealand Apprenticeship)
MACProvider Number	1	Number Type	A unique number issued by the MoE that identifies the organisation that is acting as a MAC. Please note that not all MACs are providers. Also known as the EDUMIS number. Validation: <ol style="list-style-type: none"> 1 Is a valid EDUMIS number for an active organisation that is authorised to play the role of a MAC
TrainingPlan Signed Date	1	DateType	The date the training plan was signed between the apprentice, employer and MAC. Validation: <ol style="list-style-type: none"> 1 TrainingPlanSignedDate >= TrainingAgreementSignedDate; 2 TrainingPlanSignedDate <= Today; 3 For each Pending, Hold, Grace enrolment associated with the training agreement, where enrolment

Element name	Cardinality	Data type	Description
			<p>participation start date is < TrainingPlanSignedDate, check that the programme is active as at the TrainingPlanSignedDate. This check is required, as these enrolments will have their participation start date updated to TrainingPlanSignedDate).</p>

5.16.1 Validation flow diagram

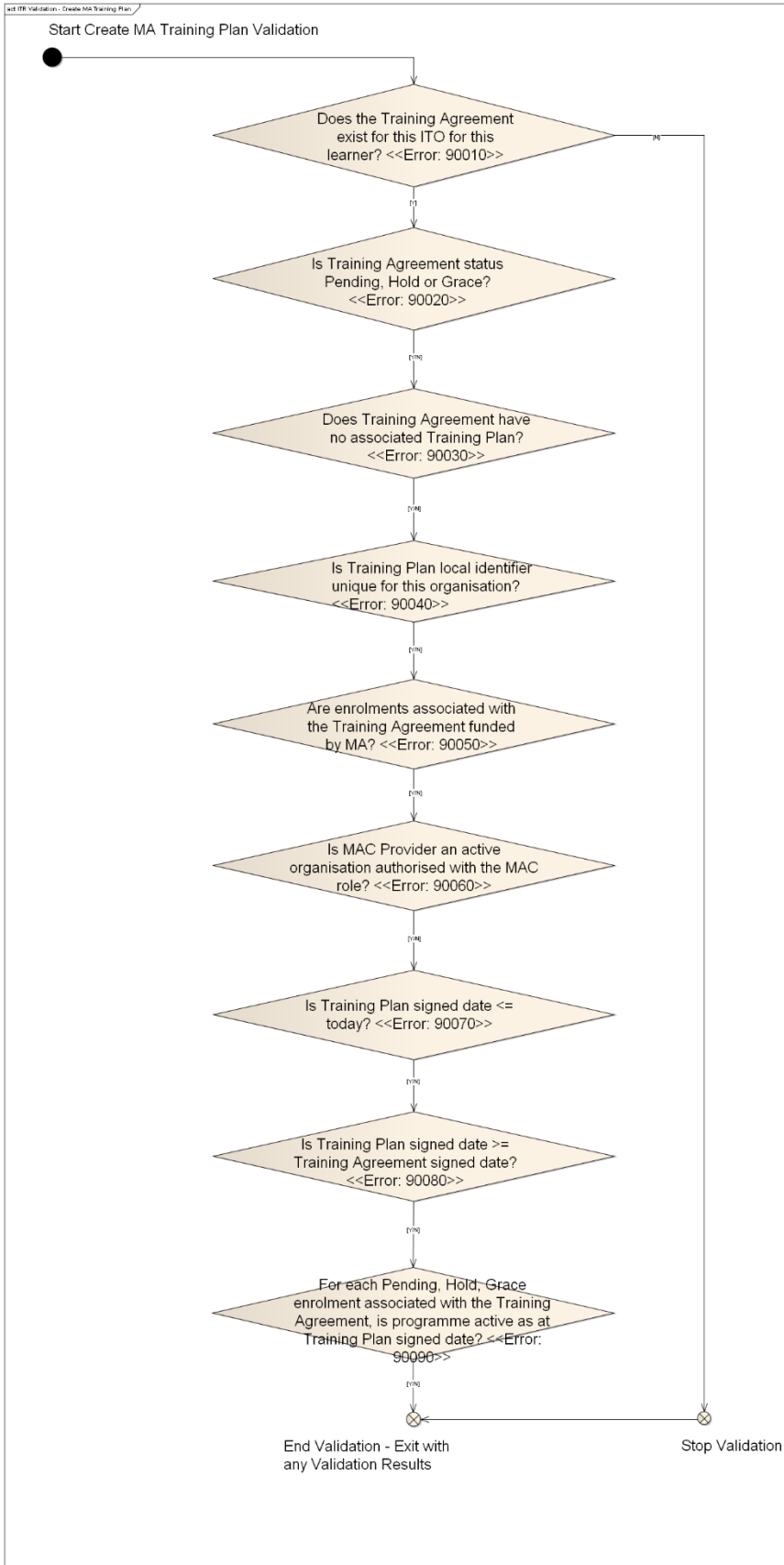

5.16.2 Business rules

The following business rules are applied if the Training Plan details are valid:

ID	Rule Description
1	Create the training plan event and save the training plan details.
2	<p>For each “Pending”, “Hold”, “Grace” enrolment associated with the training agreement:</p> <p style="padding-left: 40px;">If the enrolment participation start date is < training plan signed date, then</p> <p style="padding-left: 80px;">Update enrolment participation start date to the training plan signed date.</p> <p>Note that for complex MA or NZA, the updates listed above apply to the overarching programme enrolment and each of the sub-programme enrolments.</p> <p>Note that it is not possible to have “Active” or “Completed” enrolments against a training agreement for Complex MA or NZA enrolments where the training agreement is “Pending”, “Hold” or “Grace”, so we do not need to check for these enrolments above.</p>
3	For each “Pending” enrolment associated with the training agreement, update the enrolment status to “Active”. Note that for complex MA or NZA, this update applies to the overarching enrolment and each of the sub-programme enrolments.
4	For any enrolments that are updated in steps 2 or 3, ITR will create history records to capture the changes – refer to Section.7.7.
5	If the training agreement status is currently “Pending”, then update it to “Active”. If the training agreement status is updated, then ITR will create history records to capture the changes – refer to Section.7.7.

5.17 Transfer MAC (E23)

Just as employers can change during training, so can the MAC. The ITR provides the ability for ITOs to record a change in MAC for their apprentices. Funding for the trainee switches from one MAC to the other when the MAC transfer occurs.

The diagram below describes the elements required to transfer a MAC.

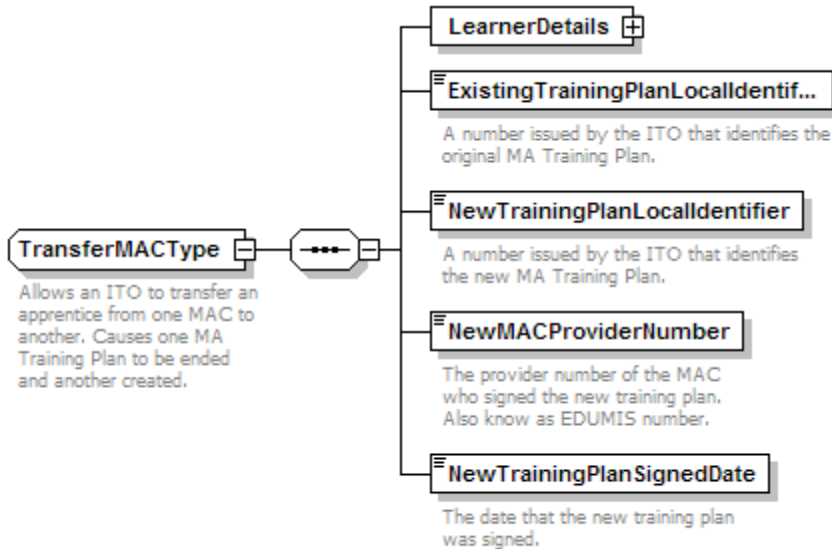

Generated with XMLSpy Schema Editor www.altova.com

The table below describes the elements required to transfer a MAC in more detail:

Element Name	Cardinality	Data Type	Description
LearnerDetails	1	Complex	See section 4.2 for details.
ExistingTrainingPlanLocalIdentifier	1	Identifier Type	An ITO issued number that uniquely identifies the old MA or NZA Training Plan Validation: 1 Must match the current MA or NZA Training Plan associated with a Training Agreement for the ITO for the learner identified in LearnerDetails. 2 Training Agreement must have a status of "Active", "Hold", "Grace" (i.e. not "Pending" or "Finished") to transfer a MAC.
NewTrainingPlanLocalIdentifier	1	Identifier Type	An ITO issued number that uniquely identifies the new MA or NZA Training Plan. Repeat validation rule 1 for local identifier in section 5.16.
NewMACProviderNumber	1	Number Type	The provider number of the MAC. Also known as the EDUMIS number. Repeat validation rule 1 for MAC provider number in section 5.16, plus the following:

Element Name	Cardinality	Data Type	Description
			<p>Validation:</p> <p>1 New MAC provider number must be different from the MAC provider on the current training plan</p>
TrainingPlanSigned Date	1	DateType	<p>The date the new MA or NZA training plan was signed.</p> <p>Repeat validation rule 2 for Training Plan signed date in section 5.16, plus the following:</p> <p>Validation:</p> <p>1 TrainingPlanSignedDate > the old TrainingPlanSignedDate</p>

5.17.1 Validation flow diagram

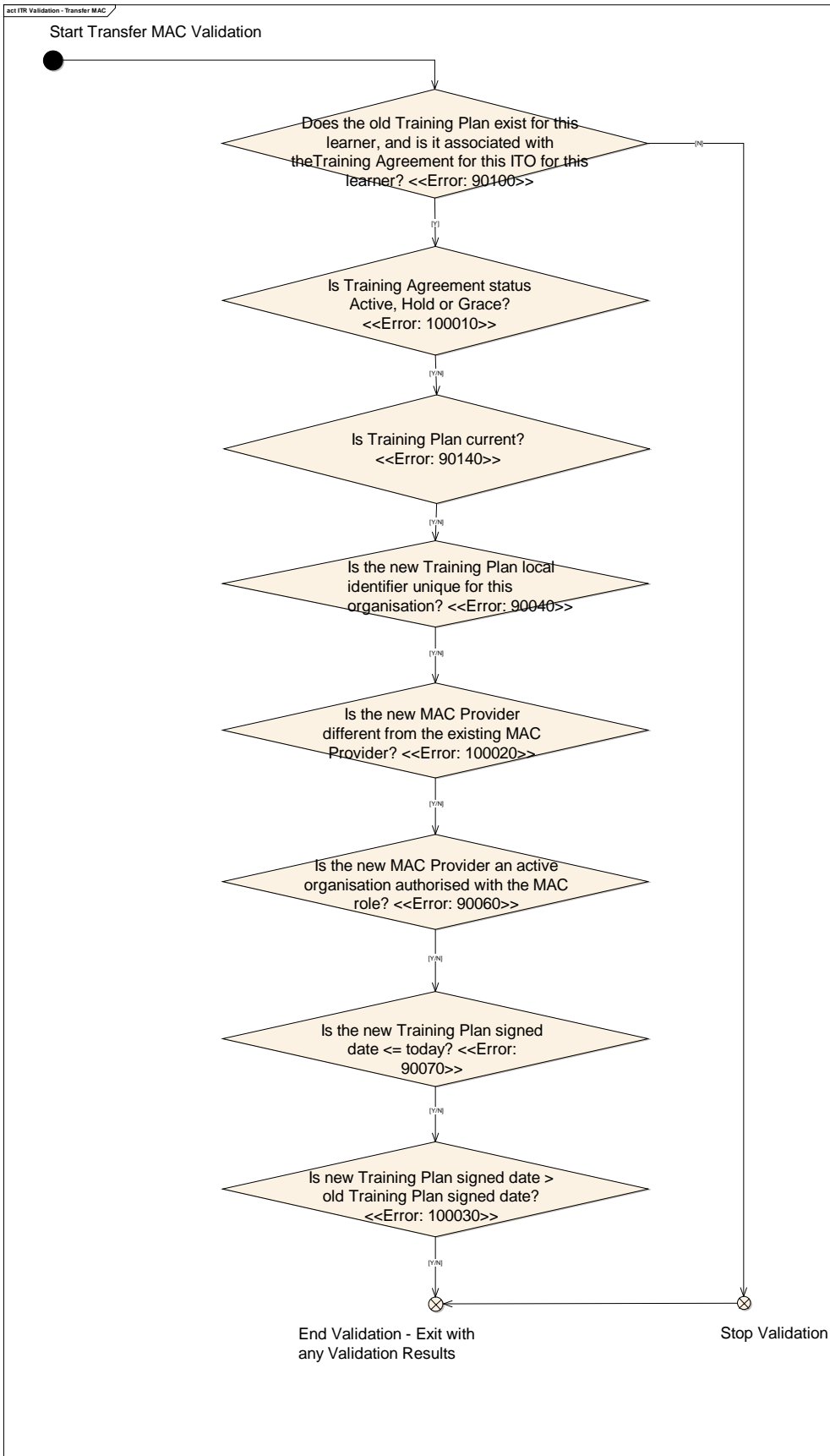

5.17.2 Business rules

The following business rules are applied if the Transfer MAC details are valid:

ID	Rule Description
1	Update the old training plan end date to the day before the new training plan signed date (it does not matter if this date is in the weekend or public holiday). ITR will create history records to capture the changes – refer to Section.7.7.
2	Create the new training plan event and save the new training plan details.

5.18 Record MAC visit (E24)

A condition of funding of modern apprenticeships is that a modern apprenticeship coordinator (MAC) must visit the apprentice at least 4 times a year. TEC requires ITOs to facilitate MACs to inform the TEC of the date a visit occurs.

MAC visits must be created after the related training plan.

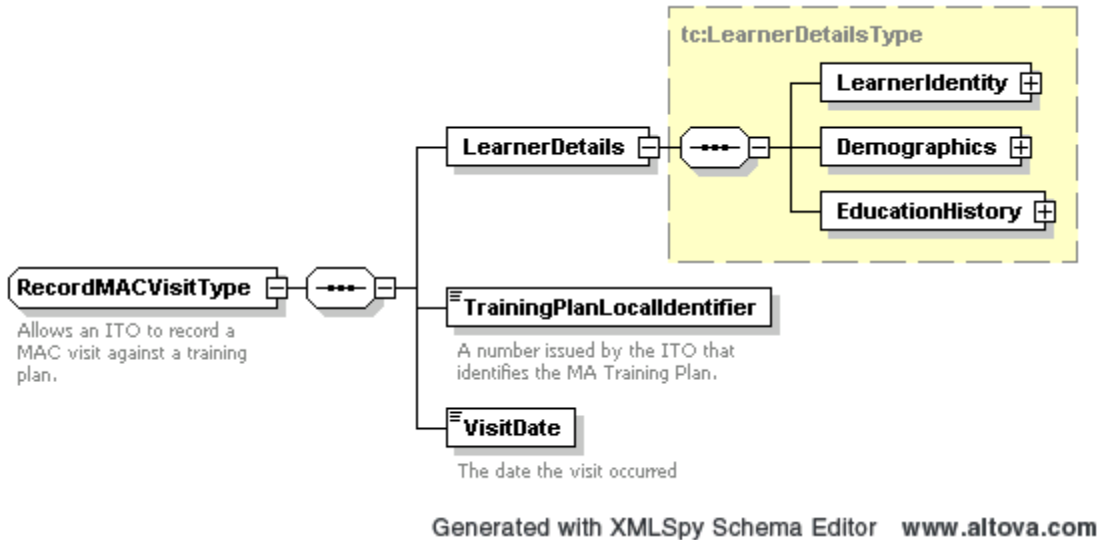

The table below describes this message in more detail:

Element name	Cardinality	Data type	Description
LearnerDetails	1	Complex	See section 4.2 for details.
MACVisit	1	Complex	Defines the visit to be recorded.
TrainingPlanLocalIdentifier	1	Identifier Type	A number issued by the ITO that uniquely identifies the training plan. Validation: 1 Must match a training plan that belongs to the learner as identified in LearnerDetails and ITO that submitted the message.
VisitDate	1	DateType	The date the visit occurred. Validation: 1 VisitDate >= TrainingPlanSignedDate 2 VisitDate <= Today 3 Cannot have 2 visits on the same day to the same learner.

5.18.1 Validation flow diagram

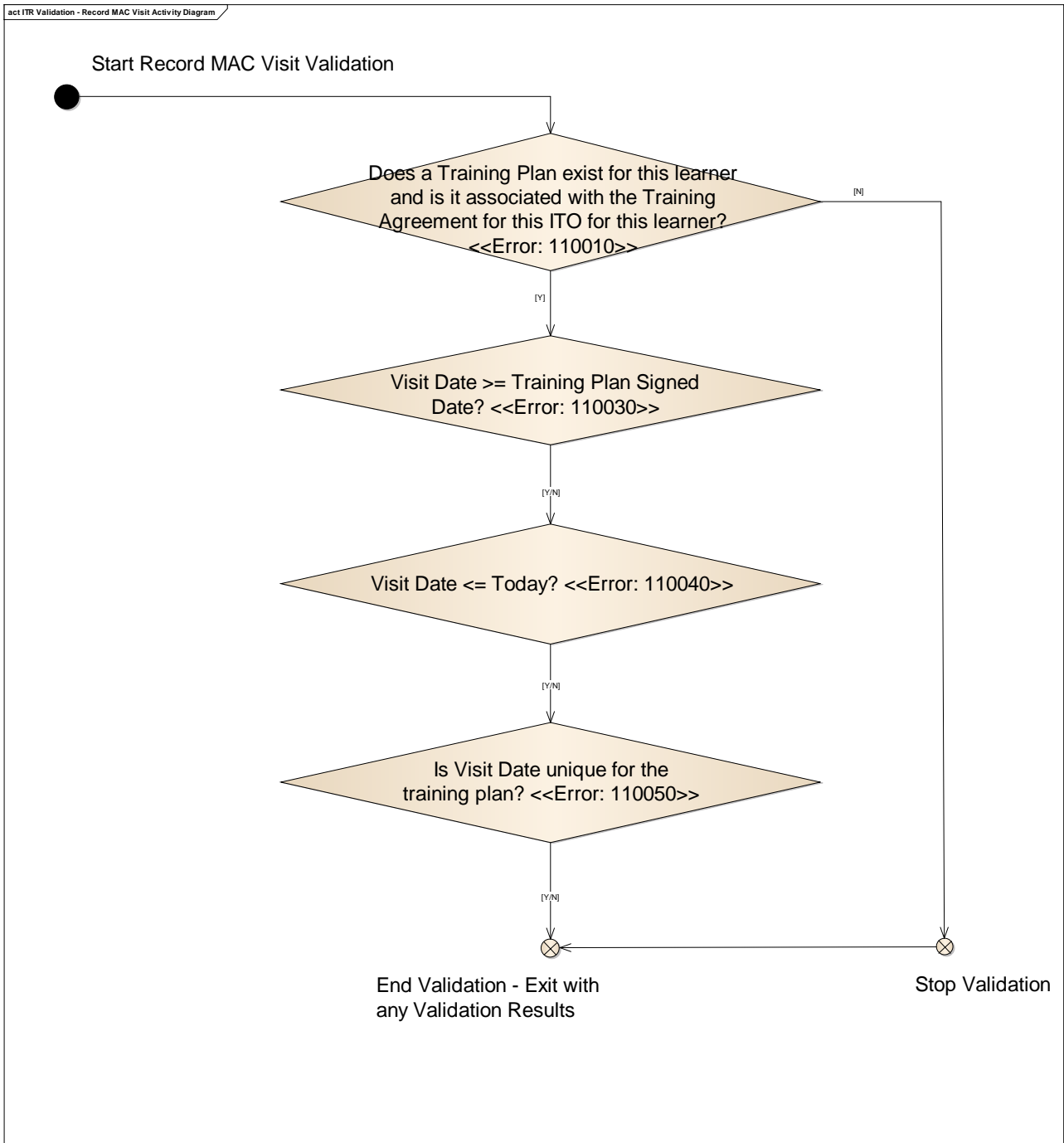

5.18.2 Business rules

The following business rules are applied if the Record MAC Visit details are valid:

ID	Rule description
1	Create the record MAC visit event.
2	A MAC visit can only be recorded against a current training plan.
3	A MAC visit can only be recorded if the associated training agreement status is "Active", "Hold" or "Grace".
4	ITR will create history records to capture the changes – refer to Section.7.7.

5.19 Delete MAC visit (E25)

The ITR will allow an ITO to delete a MAC visit if it has been incorrectly reported to the TEC. A deletion will mark the MAC visit record as logically deleted but will not physically delete the visit.

The diagram below describes the elements required to delete a MAC visit:

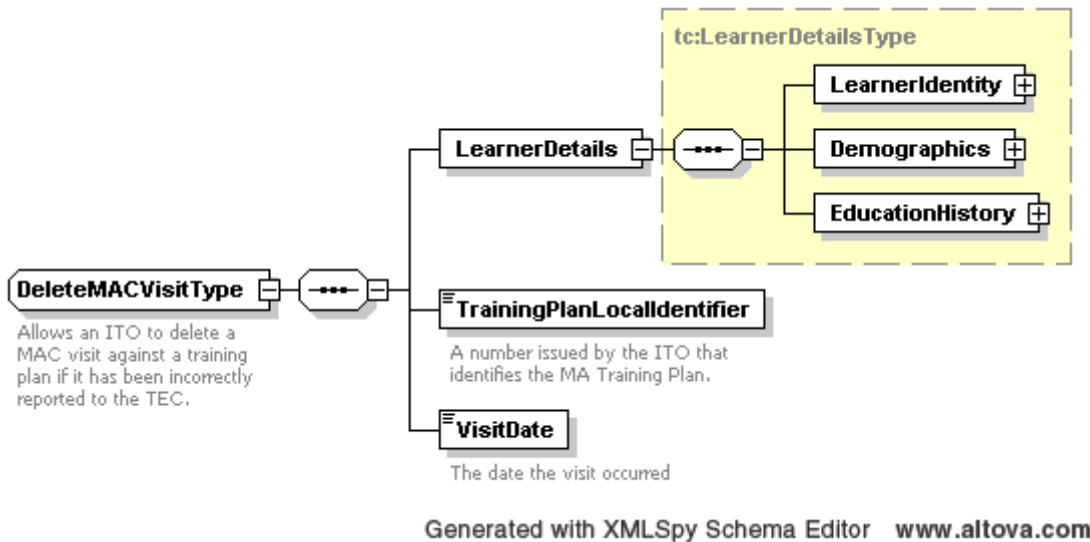

The table below describes a MAC visit message in more detail:

Element name	Cardinality	Data type	Description
LearnerDetails	1	Complex	See section 4.2 for details.
MACVisit	1	Complex	Identifies the visit to be marked as deleted.
TrainingPlan LocalIdentifier			Identifies the Training Plan the visit relates to. Validation: 1 Must match a training plan that belongs to the learner as identified in LearnerDetails and for the ITO that submitted the message. Also the training plan must be associated with a training agreement for the learner for the ITO that submitted the message..
VisitDate			Validation: 1 VisitDate must match a VisitDate associated with the TrainingPlan provided.

5.19.1 Validation flow diagram

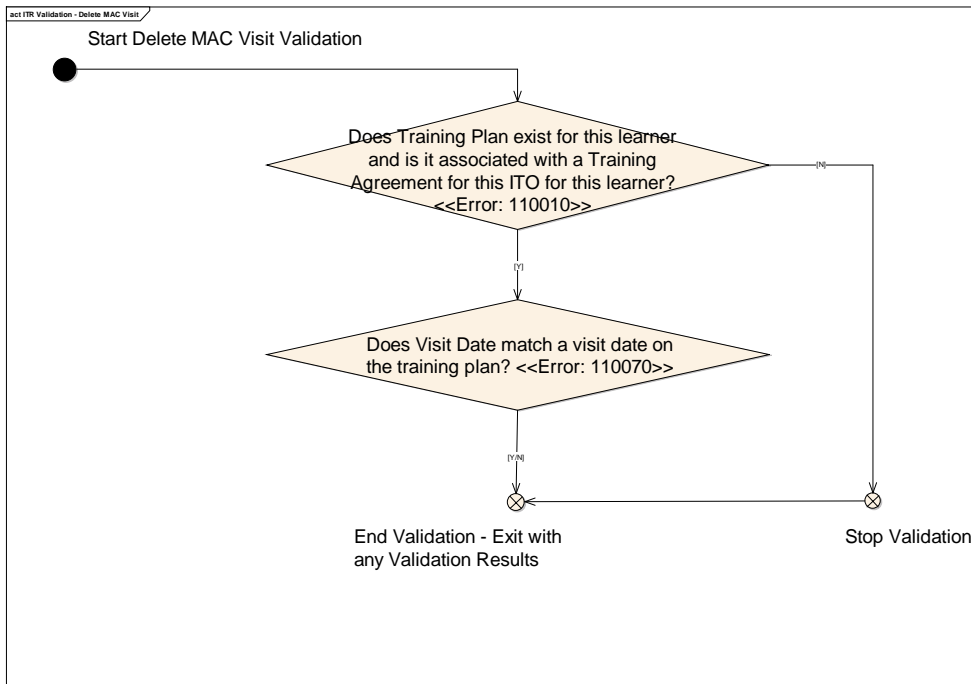

5.19.2 Business rules

The following business rules are applied if the Delete MAC Visit details are valid:

ID	Rule description
1	Create the delete MAC visit event. (A deletion will mark the MAC visit record as logically deleted but will not physically delete the visit.)
2	A MAC visit can be deleted from current and “ended” training plans.
3	A MAC visit can be deleted at any training agreement status.
4	ITR will create history records to capture the changes – refer to Section.7.7.

5.20 Update MA or NZA training plan (E26)

The purpose of the Update MA or NZA Training Plan message is to allow an ITO to change the training plan signed date if it is discovered that this date was entered incorrectly. The enrolment participation start dates will not be updated when the Training Plan signed date is updated.

The diagram below shows the elements required to update an MA or NZA training plan:

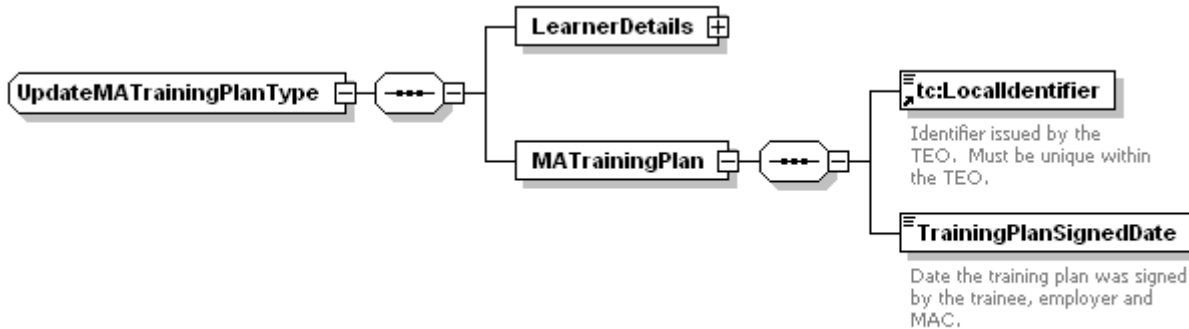

Generated with XMLSpy Schema Editor www.altova.com

The table below describes the elements of the Update Training Plan message in more detail:

Element name	Cardinality	Data type	Description
LearnerDetails	1	Complex	Common learner information supplied with all messages. See section 4.2 for details.
LocalIdentifier	1	Identifier Type	Identifies the training plan to be updated. Validation: 1 Must match a training plan that belongs to the learner as identified in LearnerDetails and for the ITO that submitted the message. Also, the training plan must be associated with a training agreement with the learner for the ITO that submitted the message. 2 The training agreement status must be "Active", "Hold" or "Grace" (i.e. not "Pending" or "Finished").
TrainingPlanSigned Date	1	DateType	The date the training plan was signed by the MAC Validation: Repeat validation rules 1 and 2 for training plan signed date in section 5.16 plus the following: 1 Check that there are no other Training Plans associated with the Training Agreement as at the new Training Plan signed date. If there are any previous Training Plans associated with the Training Agreement, where the previous Training Plan end date >= the new

Element name	Cardinality	Data type	Description
			<p>Training Plan signed date, this is invalid. This can happen if there has been a Transfer MAC event, and the ITO tries to update the Training Plan signed date of the current plan to a date in the past that overlaps with the previous Training Plan or is prior to the previous Training Plan.</p> <p>2 If the new Training Plan signed date < old Training Plan signed date, then check that there are no MAC visits where the visit date is between the old Training Plan signed date and the new Training Plan signed date (i.e. there must be no MAC visits for this Training Plan where the visit date \geq old Training Plan signed date and $<$ new Training Plan signed date).</p>

5.20.1 Validation flow diagram

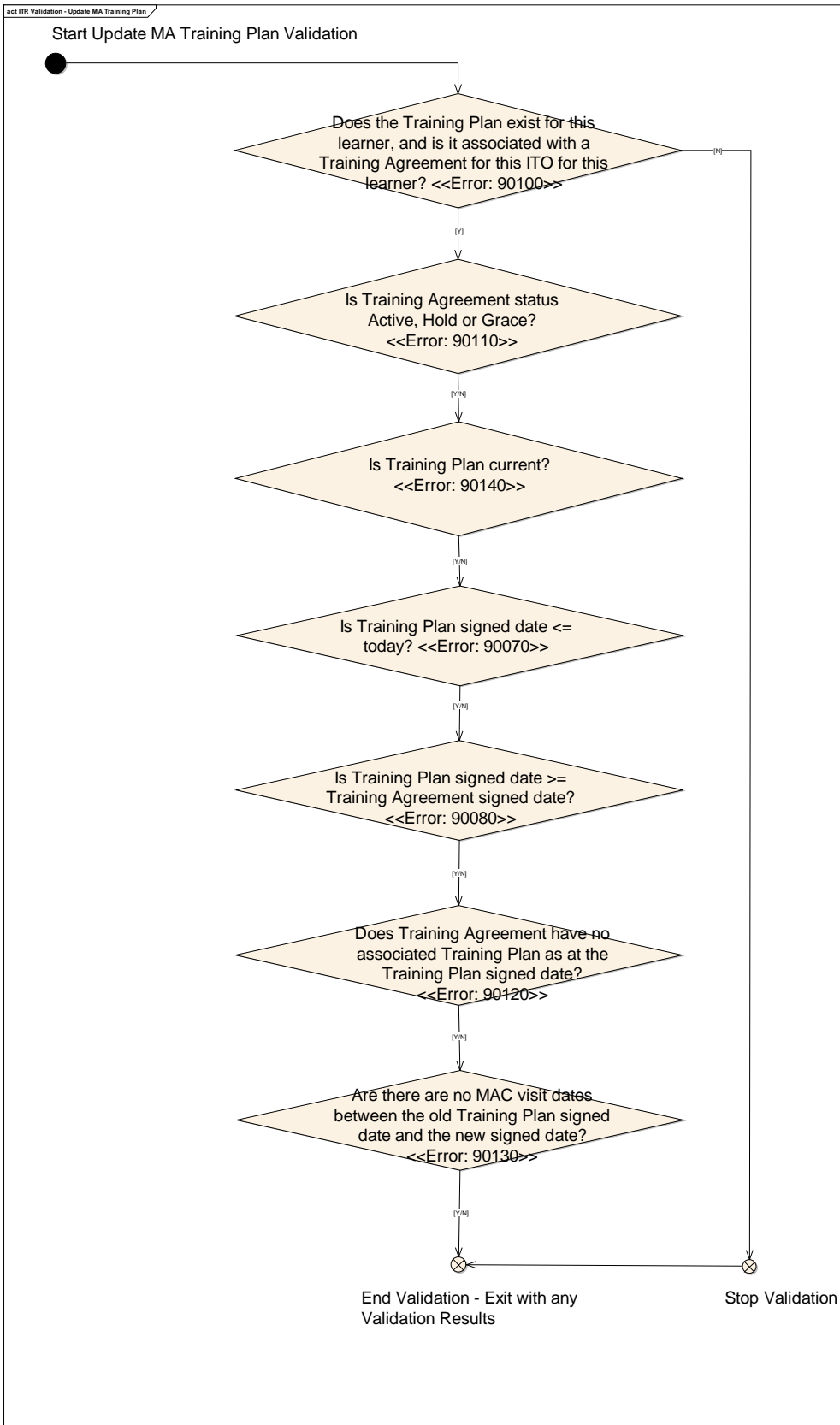

5.20.2 Business rules

The following business rules are applied if the Update MA or NZA Training Plan details are valid:

ID	Rule description
1	<p>The following elements are updatable on the Update MA or NZA Training Plan message:</p> <ul style="list-style-type: none">• Training Plan Signed Date
2	<ul style="list-style-type: none">• ITR will create history records to capture the changes – refer to Section.7.7• Update the training plan signed date.• On the original training plan learner event:<ul style="list-style-type: none">○ Update Event Occurred Date to the new training plan signed date.○ Update Event Reported Date to the message processing date.

5.21 Update learner details (E27)

ITOs will have the ability to update a learner's details. This can either be done as part of a learner event such as Create Training Agreement, or as a standalone message if only the learner's details are required to be updated.

The main purpose of the standalone message is to allow ITOs to update the NSN of the learner. If a user changes the NSN of a learner, the ITO must send an UpdateLearnerDetails message to the ITR which will be validated against the NSI. Keeping NSNs up to date will help ensure ITR successfully detects completions recorded on the Record of Achievement (RoA).

Changes to other learner details are not as critical to be kept in synch so these changes can be submitted the next time the ITO can submit the next event for the learner.

The rules and validations for updating the learner are the same as detailed in Section 4.2, with one additional validation.

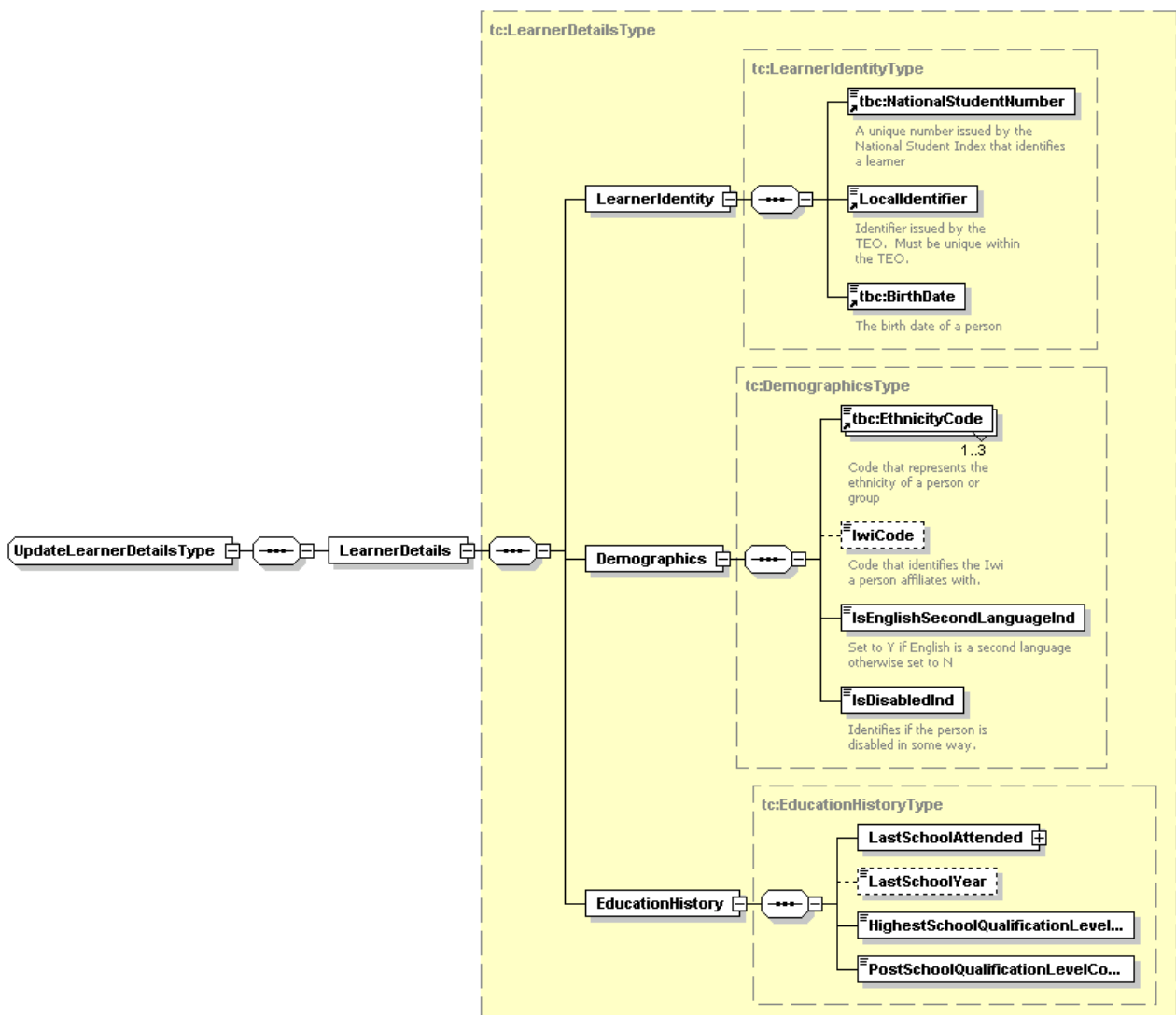

Generated with XMLSpy Schema Editor www.altova.com

5.21.1 Additional validation rules

In addition to the learner validation rules listed in Section 4.2, please note the following:

1. The ITO must have already submitted a learner event previously for this learner. This ensures that the learner already exists and is associated with this ITO before the ITO can update the learner details.

When applying updates to the Learner Details, the ITR database will be updated with the Master NSN from the NSI. This will keep ITR in synch with the NSI to help manage merges and splitting of student records.

When the Learner Details record is updated, ITR will create an associated Learner History record. Refer to Section 7.5 for further details.

5.22 Transfer Simple Programme Course Version (E28)

Where a trainee or modern apprentice needs to be enrolled in the latest version of a Programme, the TransferProgrammeCourseVersionSimpleEnrolment message can be used by ITOs to provide the ITR with a snapshot of the enrolment after the changes have been applied within the TMS.

The programme course version of the enrolment that the trainee or modern apprentice is to be transferred to should represent the learning after the transfer date. Any learning prior to the transfer date, or not part of the new programme course version should be excluded from the transfer.

5.22.1 Simple enrolments allowed at Transfer

In progress Simple enrolments will be allowed when:

- Programme course version is registered and must exist
- Programme course version is Active as at the date of Transfer
- Programme course version must be of the same programme course number the learner was originally enrolled in

The outcome of the transfer will contain:

- The programme course version the trainee has transferred to
- Enrolment status is "Active", "Hold", or "Grace"
- Unit standards achieved after Transfer Date
- Non-achieved unit standards

5.22.2 Unit standards allowed at Transfer

Unit standards will be allowed on the transferred enrolment when:

- For an LCP or SCP, the unit standard exists in programme course version the learner is to be transferred to
- The unit standard has been achieved after the Transfer Date
- The unit standard is not been achieved

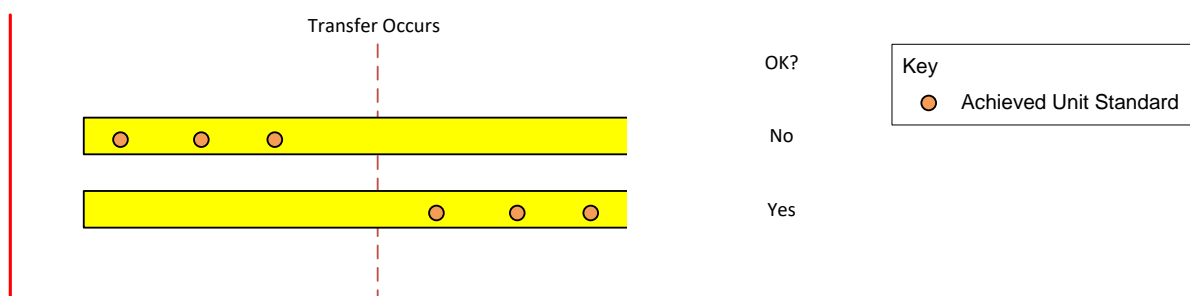

Achieved unit standards as part of the previous version which not included in the transfer will still be recognized by the TEC.

The diagram below describes the elements required to transfer a simple enrolment in a programme to a version of the programme course the learner is enrolled in.

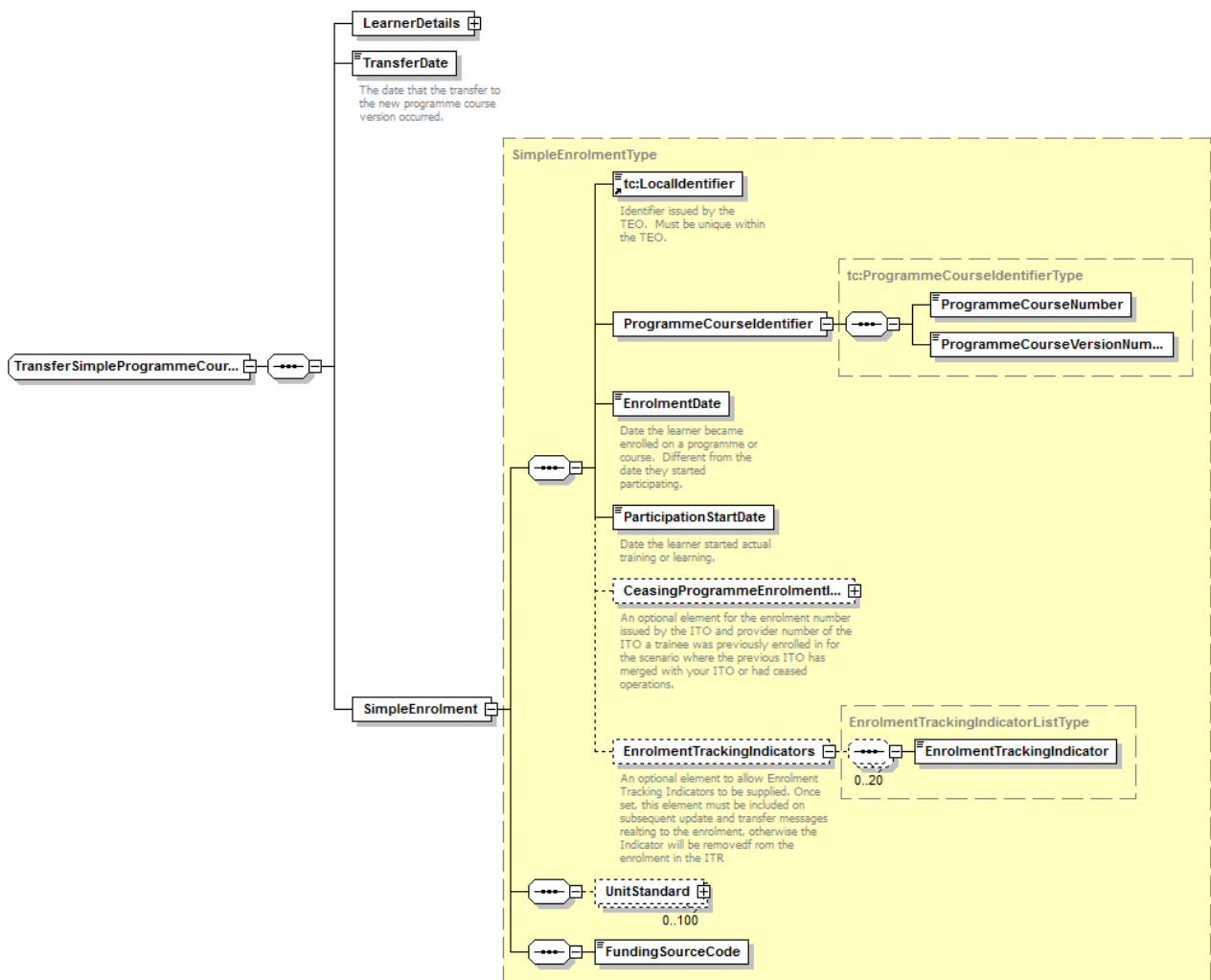

Generated with XMLSpy Schema Editor www.altova.com

The table below describes the transfer simple programme course version message in more detail.

Element name	Cardinality	Data type	Description
LearnerDetails	1	Complex	See section 4.2 for a definition and base validation rules.
LocalIdentifier	1	Identifier Type	<p>A string that uniquely identifies the enrolment in a programme. Should be different from the training agreement LocalIdentifier.</p> <p>Validation:</p> <ol style="list-style-type: none"> 1 Must match an enrolment that belongs to the learner as identified in LearnerDetails and for the ITO that submitted the message. 2 The enrolment status must not be “Withdrawn” or “Completed”

Element name	Cardinality	Data type	Description
			3 Must not match an enrolment that is part of a Complex Modern Apprenticeship
ProgrammeCourse Identifier	1	Complex	Identifies the Programme or Course the trainee is enrolled on. See section 5.5.4 for details. Validation: 1 The programme must exist and the ITO must be authorised to deliver the programme. 2 The programme course the learner is to be transferred to must be of the same programme course number. 3 The programme version must be Active as at the TransferDate.
EnrolmentDate	1	DateType	See section 5.5.4 for definition. Validation: 1 Must match the EnrolmentDate on the original enrolment.
ParticipationStart Date	1	DateType	See section 5.5.4 for definition and base validation rules. Validation: 1 Must match the ParticipationStartDate on the original enrolment. If the ITO needs to change the ParticipationStartDate they will need to withdraw the enrolment and create a new enrolment.
TransferDate	1	DateType	Date the transfer became effective. Validation: 1 TransferDate > ParticipationStartDate 1 TransferDate >= latest TransferDate Note: latest TransferDate represents the date the enrolment was last transferred to a different programme course version.
UnitStandard	0..100	Complex	See section 5.5.4 for definition. Validation: 1 StandardNumber and StandardVersionNumber must be registered and active at NZQA as at the TransferDate. 2 StandardNumber and StandardVersionNumber must not match

Element name	Cardinality	Data type	Description
			<p>a unit standard on the learner's Record of Achievement before the TransferDate.</p> <p>3 If a standard was listed in the current enrolment it must appear in the updated enrolment if it has been added to the trainee's RoA since the enrolment transfer date.</p> <p>For all other units listed i.e. those not previously achieved, repeat validation rules 3, 4, 6, 7 and 8 in section 5.5.4.</p>
FundingSourceCode	1	Code Type	<p>See section 5.5.4 for definition.</p> <p>Validation:</p> <p>1 The FundingSourceCode must be a valid value for the programme course version the Trainee is to be transferred to</p> <p>Where the value supplied = "MA" or "NZA" the learner cannot have any other "Active", "Pending", "Hold" or "Grace" MA or NZA enrolments at any ITO.</p> <p>Where the Funding Source Code is NZA the Programme Funding Source of NZA must be "Approved"</p>
CeasingProgrammeEnrolmentIdentifier	0..1	Complex	<p>See section 4.6 for details</p> <p>The Ceasing Programme Enrolment Identifier is not supported for this message.</p> <p>Do not supply data in this field for this message.</p>
EnrolmentTrackingIndicator	0..20	Complex	<p>See section 4.7 for details</p> <p>Supplied Enrolment Tracking Indicators must be valid</p>

5.22.3 Validation Flow Diagram

Validation of Simple Enrolments is made up of three parts:

1. Learner Details – Details about the learner are validated as described in section 4.2.
2. Simple Enrolment Validation
 - a. General checks
 - b. Transfer date checks
 - c. Unit Standard checks
3. Simple enrolment validation.

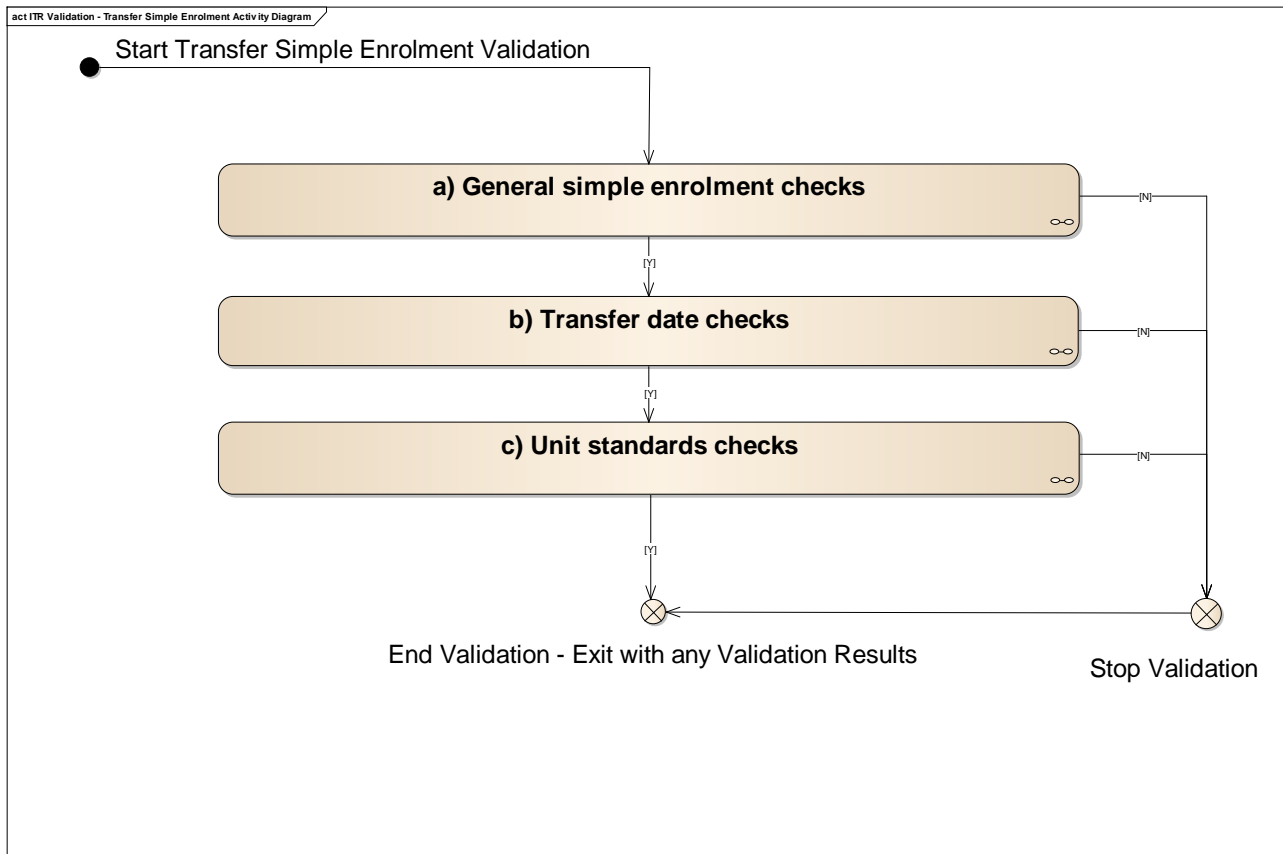

a. General Checks

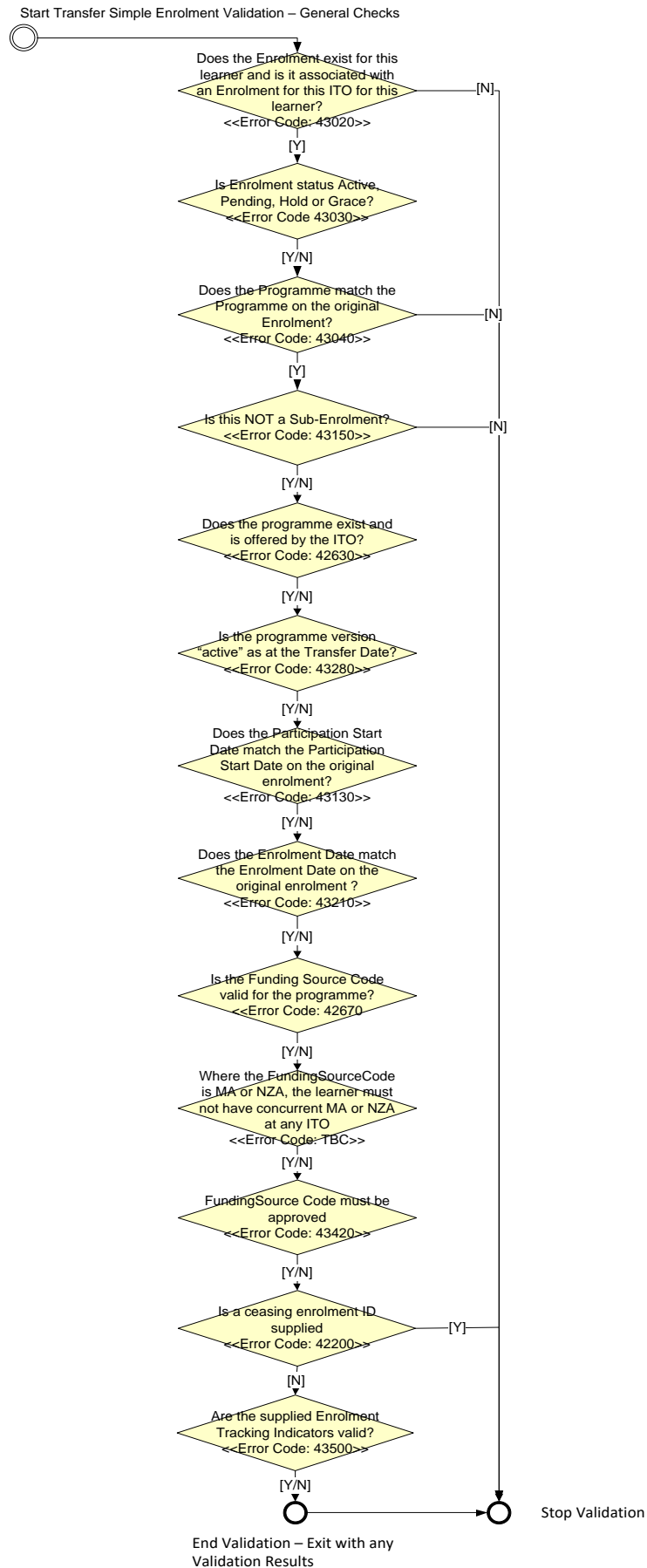

b. Transfer date checks

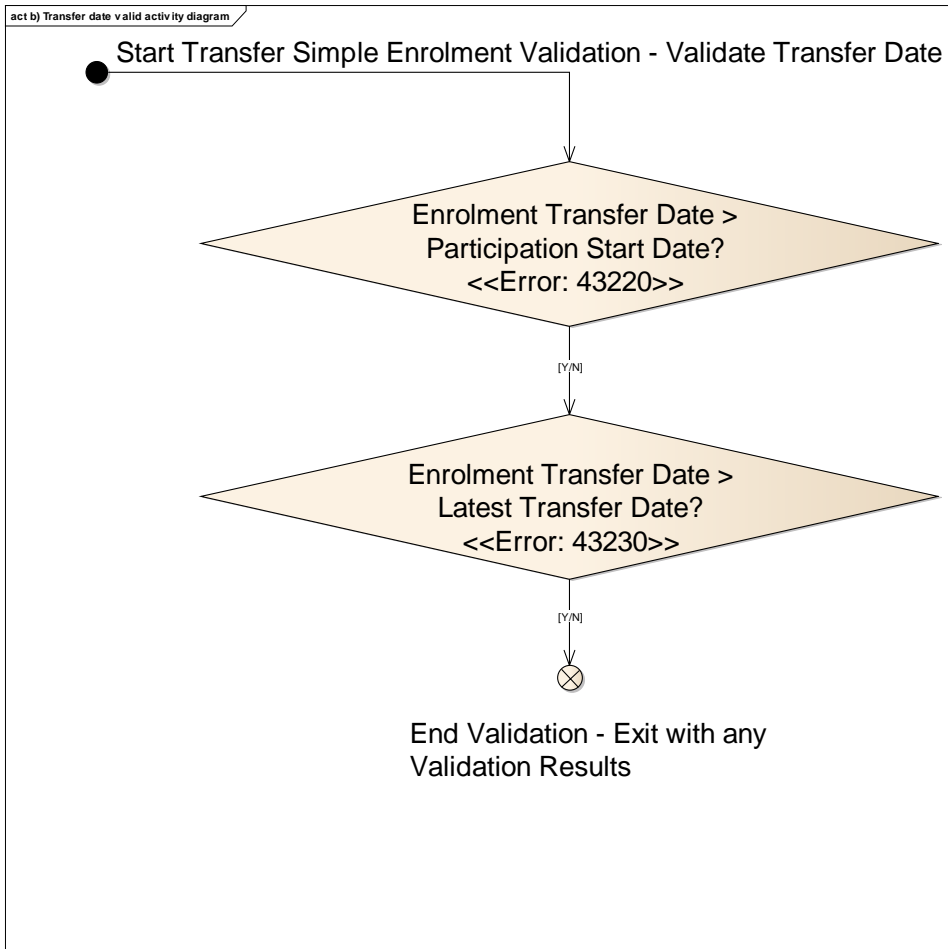

c. Unit standard checks

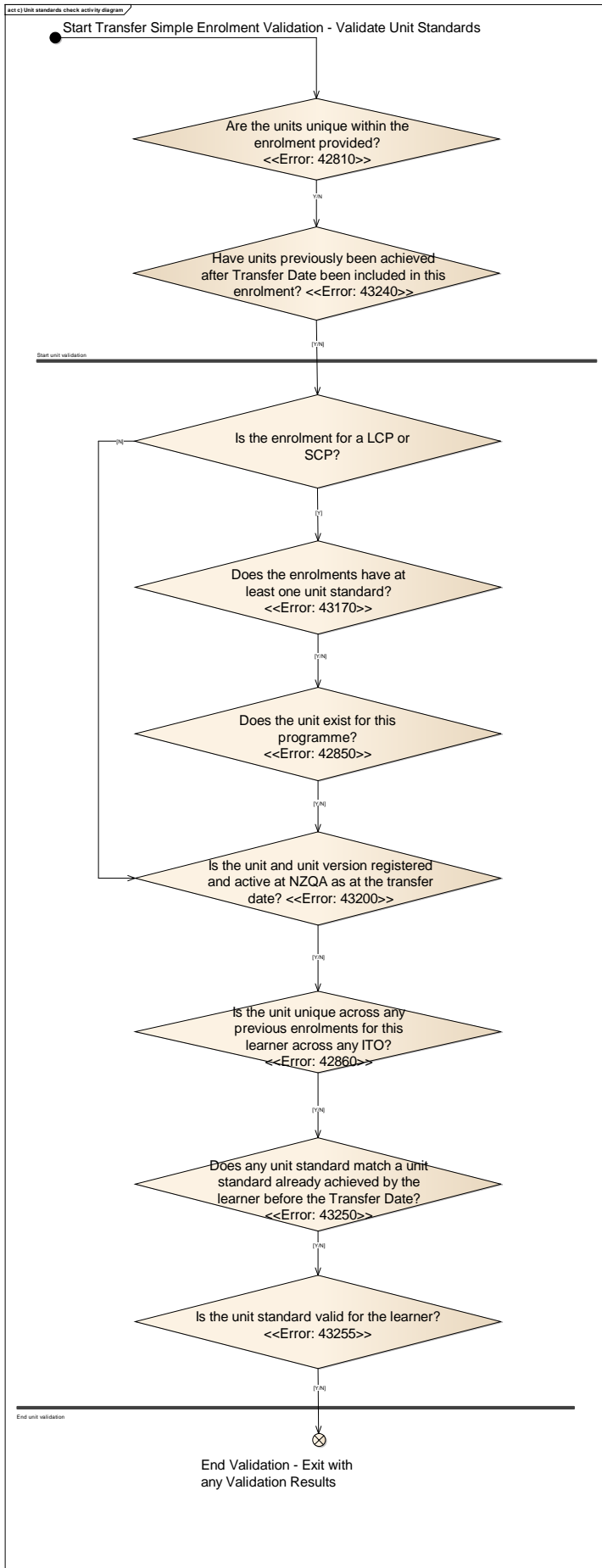

5.22.4 Business rules

The following business rules are applied if the Transfer Simple Enrolment details are valid:

ID	Rule Description
1	<p>The following elements are updatable in the Transfer Programme Course Version for Simple Enrolment message:</p> <ul style="list-style-type: none">• Programme Course Identifier• Unit Standard
2	<ul style="list-style-type: none">• ITR will create history records to capture the changes – refer to Section 7.7<ul style="list-style-type: none">○ Create the transfer programme course version event and associate the transfer programme course version event with the original and new (transferred) enrolment

5.23 Transfer Complex Modern Apprenticeship Programme Course Version (E29)

Where a modern apprentice needs to be enrolled in the latest version of a Complex Modern Apprenticeship Programme, the TransferComplexModernApprenticeship-ProgrammeCourseVersion message is used by ITOs to provide the ITR with a snapshot of the enrolment after the changes have been applied within the TMS.

5.23.1 Sub-programme enrolments allowed at Transfer

In progress sub-programme enrolments and completed sub-programme enrolments will be allowed when:

- Sub-programme course version is Active as at the Transfer Date
- Sub-programme course version must be of the same programme course number the learner was originally enrolled in
- Sub-programme course version must exist in the overarching programme course version the learner is to be transferred to
- Sub-programme enrolment is completed on or after the Transfer Date

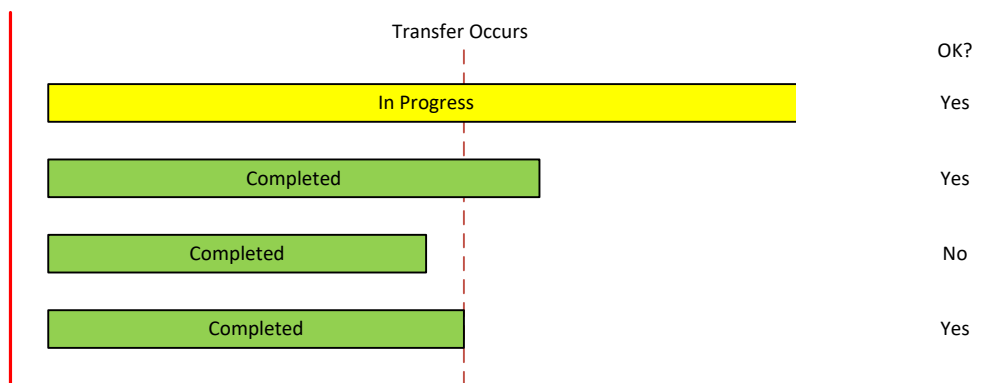

Where the learner has a single sub-programme enrolment to complete and requires to be transferred to a programme course version, the ITR will allow a transfer of a Complex Modern Apprenticeship enrolment in a single sub-programme enrolment. It will be optional to provide at least one unit standard where the learner has completed all the additional unit standard [and/or] a sub-programme enrolment before the latest transfer date. This will also be applied to any following Update Complex MA or NZA programme enrolment message.

The outcome of the transfer will be:

- Overarching programme course version the trainee has transferred to
- Sub-programme course version the trainee has transferred to
- Overarching programme enrolment status is “Active”, “Hold”, or “Grace”
- Unit standards achieved after Transfer Date
- Non-achieved unit standards
- Additional unit standards may be optionally supplied if the trainee has previously completed a sub-programme enrolment or all the additional unit standards

5.23.2 Unit standards allowed at Transfer

Units standard will be allowed on the transferred enrolment when:

- If unit standard is an additional unit standard, it must exist in the overarching programme course version the learner is to be transferred to.
- The unit standard has been achieved after the Transfer Date
- The unit standard has not been achieved

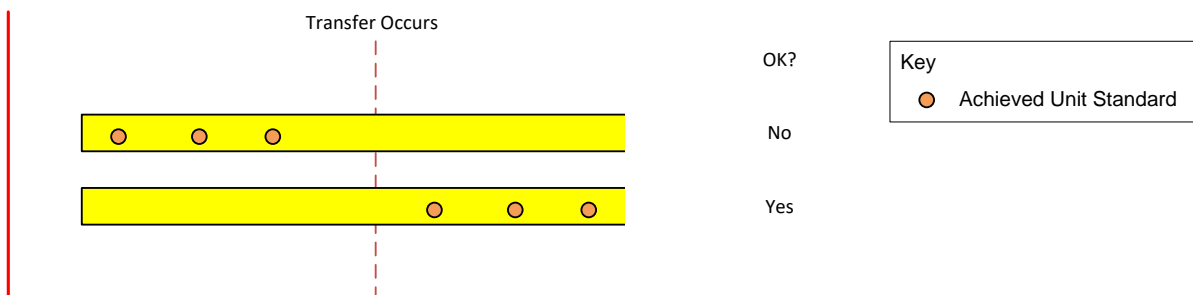

Achieved unit standards as part of the previous version which are not included in the transfer will still be recognized by the TEC.

The diagram below describes the elements required to transfer a simple enrolment in a programme to the latest version.

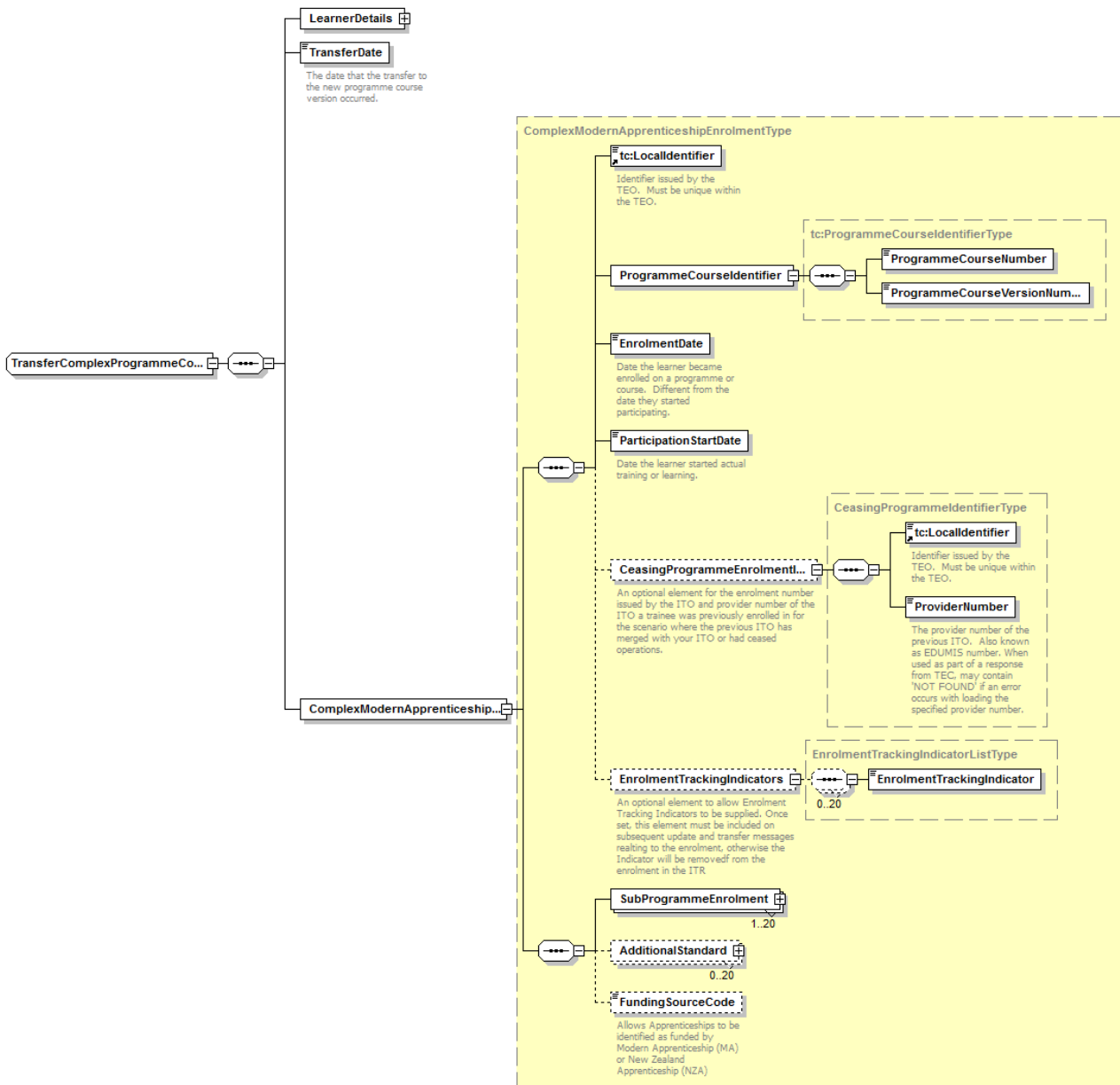

Generated with XMLSpy Schema Editor www.altova.com

The table below describes the transfer simple programme course version message in more detail.

Element name	Cardinality	Data type	Description
LearnerDetails	1	Complex	See section 4.2 for a definition and base validation rules.
LocalIdentifier	1	Identifier Type	<p>A string that uniquely identifies the enrolment in a programme. Should be different from the training agreement LocalIdentifier.</p> <p>Validation:</p> <ol style="list-style-type: none"> 1 Must match an enrolment that belongs to the learner as identified in LearnerDetails and for the ITO that submitted the message. 2 Must be for the overarching programme enrolment. 3 The enrolment status must not be "Withdrawn" or "Completed".
ProgrammeCourse Identifier	1	Complex	<p>Identifies the Programme or Course the trainee is enrolled on.</p> <p>See section 5.5.7 for details.</p> <p>Validation:</p> <ol style="list-style-type: none"> 1 The programme must exist and the ITO must be authorised to deliver the programme. 2 The programme course the learner is to be transferred to must be of the same programme course number. 3 The programme version must be Active as at the TransferDate.
EnrolmentDate	1	DateType	<p>See section 5.5.7 for definition.</p> <p>Validation:</p> <ol style="list-style-type: none"> 1 Must match the EnrolmentDate on the original enrolment.
ParticipationStart Date	1	DateType	<p>See section 5.5.7 for definition and base validation rules.</p> <p>Validation:</p> <ol style="list-style-type: none"> 1 Must match the ParticipationStartDate on the original enrolment. <p>If the ITO needs to change the ParticipationStartDate they will need to withdraw the enrolment and create a new enrolment.</p>
TransferDate	1	DateType	<p>Date the transfer became effective.</p> <p>Validation:</p> <ol style="list-style-type: none"> 1 TransferDate > ParticipationStartDate

Element name	Cardinality	Data type	Description
			<p>2 TransferDate >= latest TransferDate</p> <p>Note: latest TransferDate represents the date the learner last transferred to a programme course version.</p>
SubProgramme Enrolment	1..20	Complex	<p>Details about the sub-programme enrolments contained within the complex MA or NZA enrolment.</p> <p>See section 5.5.7 for definition and base validation rules.</p> <p>Validation:</p> <p>Apply the validation rules described in section 5.5.7, plus the following:</p> <ol style="list-style-type: none"> 1 ParticipationStartDate must match the ParticipationStartDate on the original sub-programme enrolment. 2 A completed sub-programme before the TransferDate must not be included. 3 A completed sub-programme on or after the TransferDate must be included. 4 A completed sub-programme cannot be included in the transfer if it does not exist in the Complex Modern Apprenticeship programme course version the Trainee is to be transferred to. <p>Note: ITR will not update any sub-programme enrolment that has a status of "Completed".</p> <ol style="list-style-type: none"> 5 Sub-programme enrolment status must not be "Withdrawn". 6 Repeat the unit standard validation rules for TransferSimpleProgrammeCourseVersion (Section 5.22) except the following: <ol style="list-style-type: none"> a. where any unit standard validation rule is LCP/SCP specific
AdditionalStandard	0..20	Complex	<p>See section 5.5.7 for definition and base validation rules.</p> <p>Validation:</p> <p>Repeat the unit standard validation rules for TransferSimpleProgrammeCourseVersion (Section 5.22) except the following:</p> <ol style="list-style-type: none"> 1 where any unit standard validation rule is LCP/SCP specific. The AdditionalStandard

Element name	Cardinality	Data type	Description
			must be a standard listed on the programme definition of the overarching programme.
FundingSourceCode	0..1	CodeType	<p>See section 5.2.3 for details</p> <p>Validation</p> <p>The FundingSourceCode must be a valid value for the programme course version the Trainee is to be transferred to.</p> <p>Where the value supplied = "MA" or "NZA" the learner cannot have any other "Active", "Pending", "Hold" or "Grace" MA or NZA enrolments at any ITO.</p> <p>Where the Funding Source Code is NZA the Programme Funding Source of NZA must be "Approved"</p>
CeasingProgrammeEnrolmentIdentifier	0..1	Complex	<p>See section 4.6 for details</p> <p>The Ceasing Programme Enrolment Identifier is not supported for this message.</p> <p>Do not supply data in this field for this message.</p>
EnrolmentTrackingIndicator	0..20	Complex	<p>See section 4.7 for details</p> <p>Supplied Enrolment Tracking Indicators must be valid</p>

5.23.3 Validation flow diagram

Validation of Updating Complex MA or NZA Enrolments is made up of three parts:

1. Learner Details – Details about the learner are validated as described in section 4.2.
2. Complex Modern Apprenticeships or New Zealand Apprenticeships validation – Rules relating to Complex Modern Apprenticeship and New Zealand Apprenticeship performed as per the diagram below:

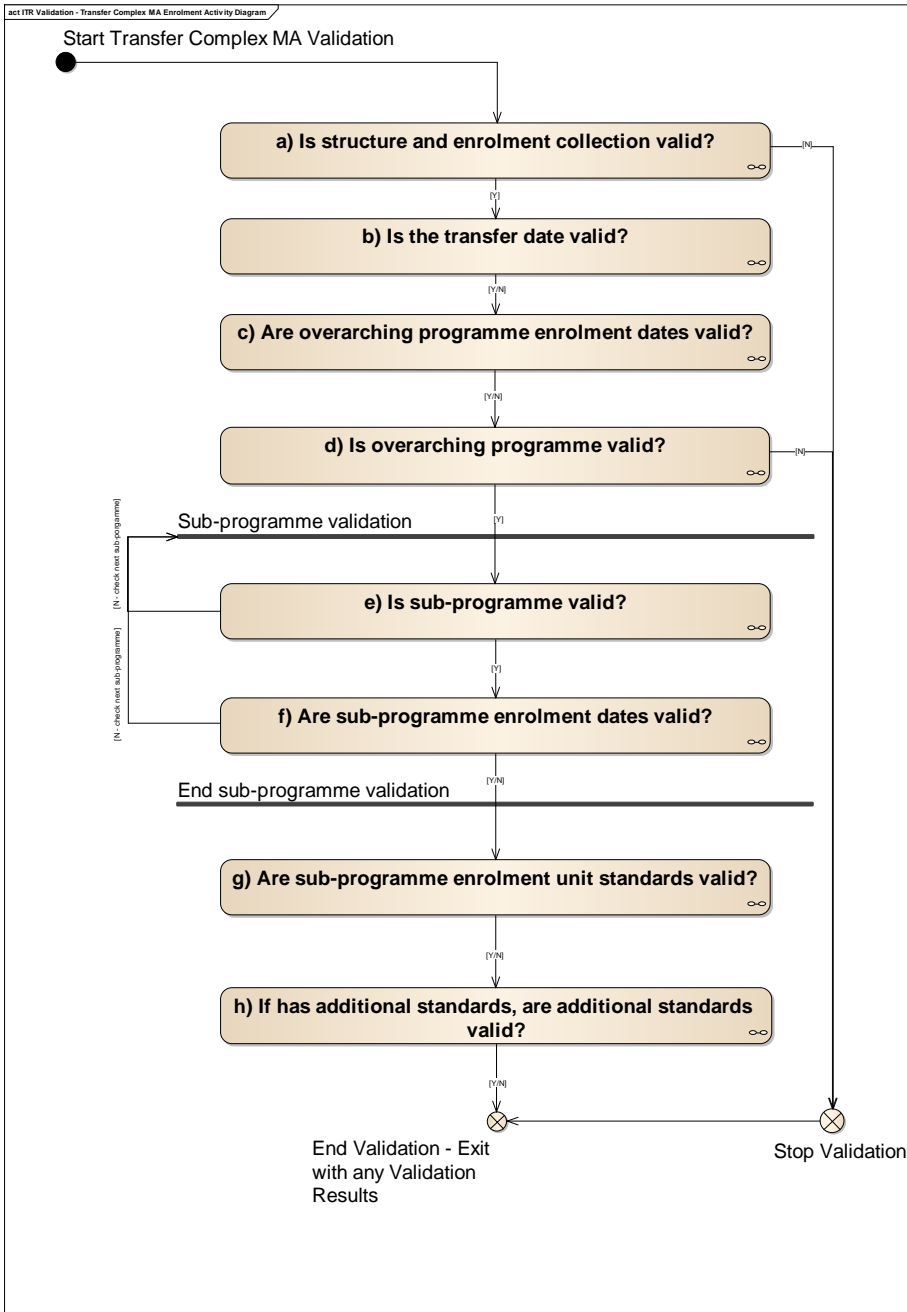

a. Is structure and enrolment collection valid?

Is structure and enrolment collection valid activity diagram

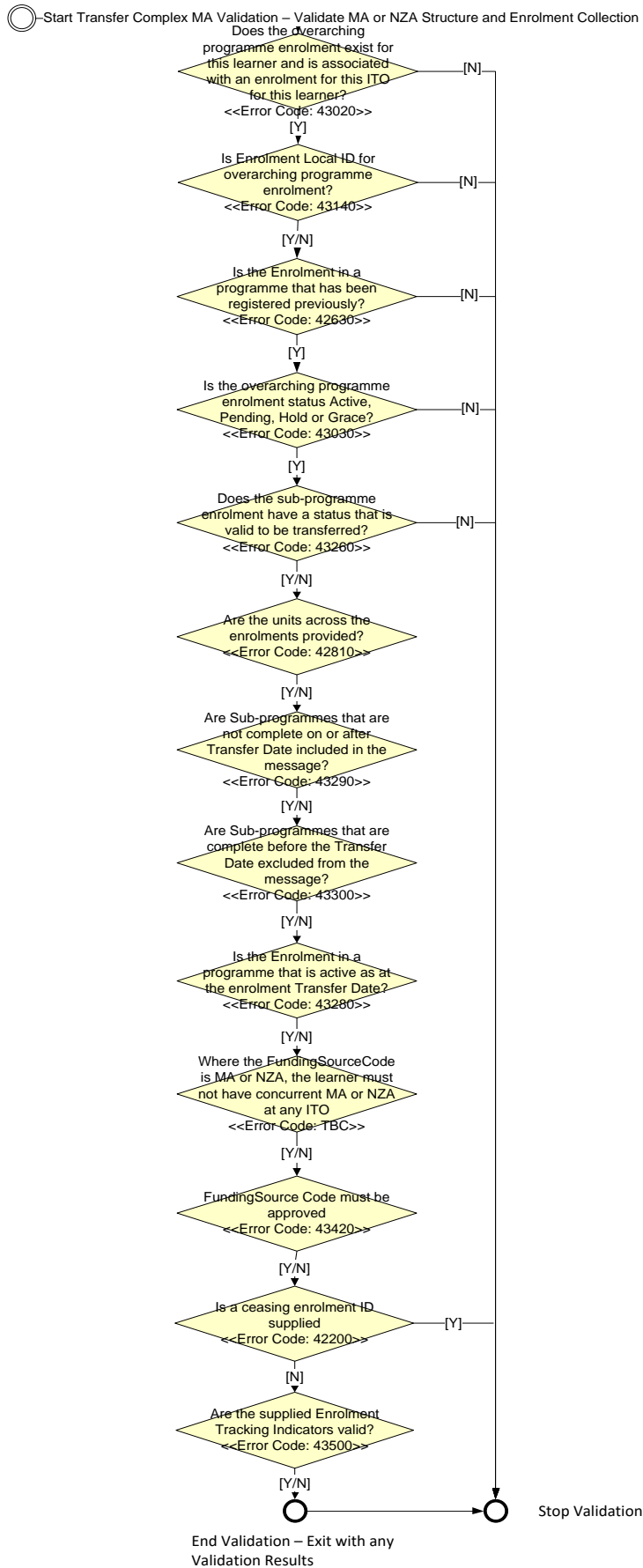

b. Is the transfer date valid?

Is the transfer date valid activity diagram

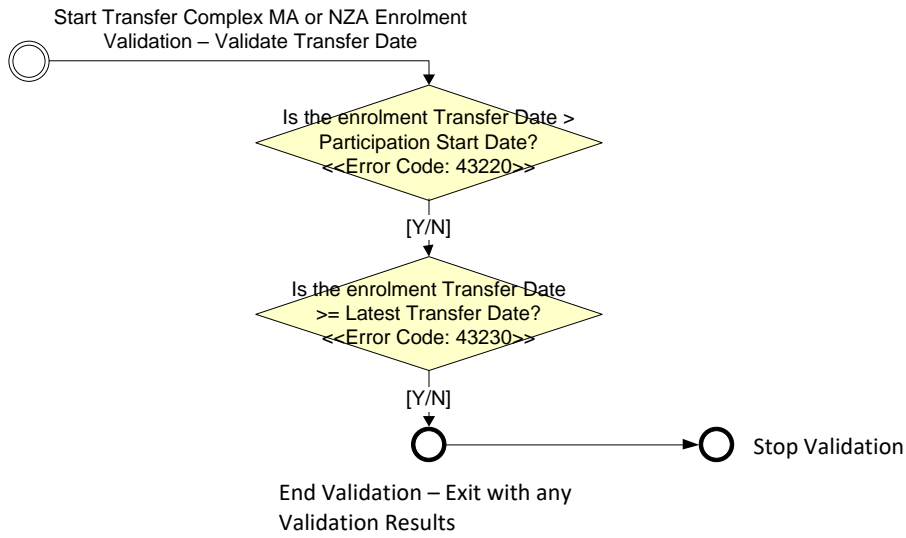

c. Is overarching programme valid?

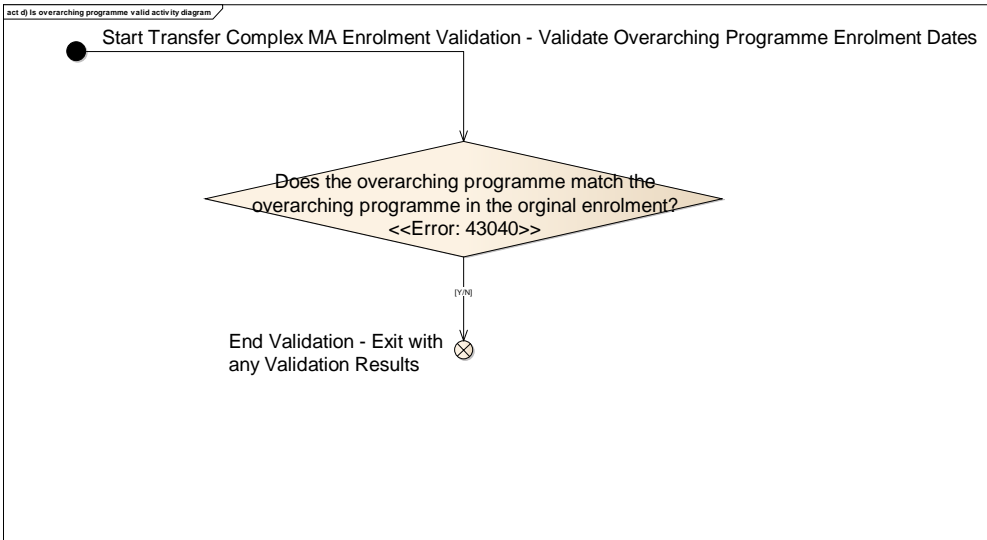

d. Are overarching programme enrolment dates valid?

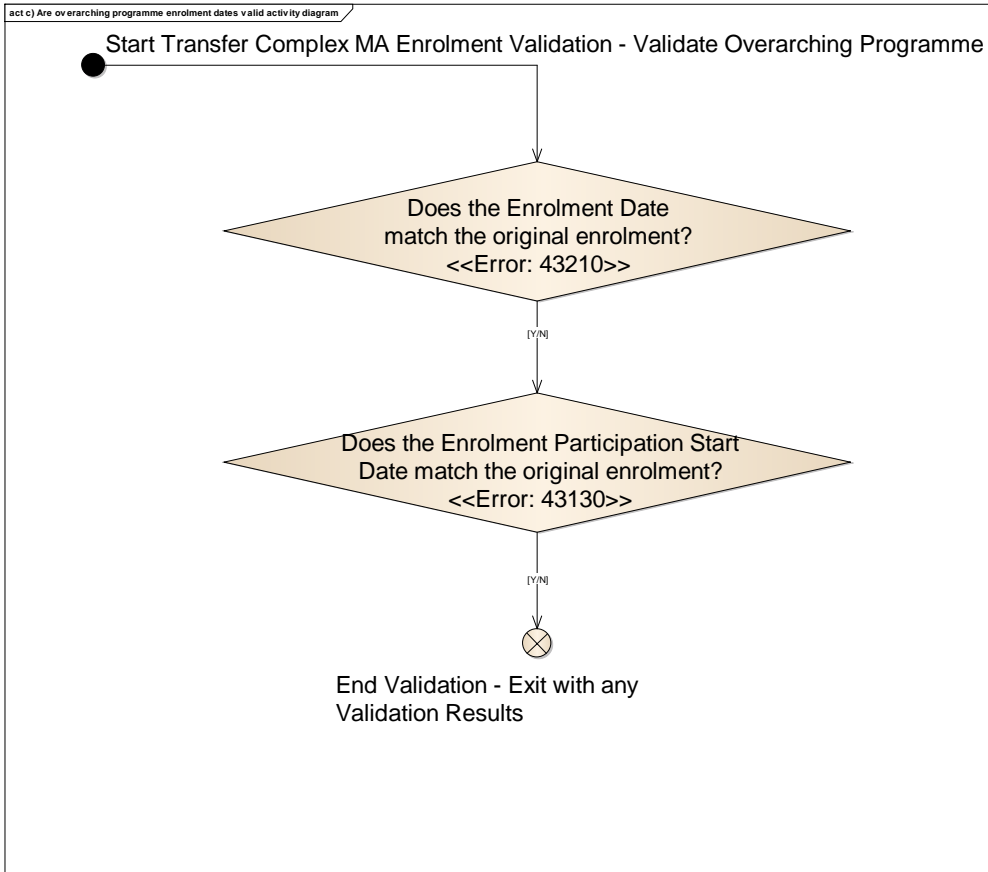

e. Is sub-programme valid?

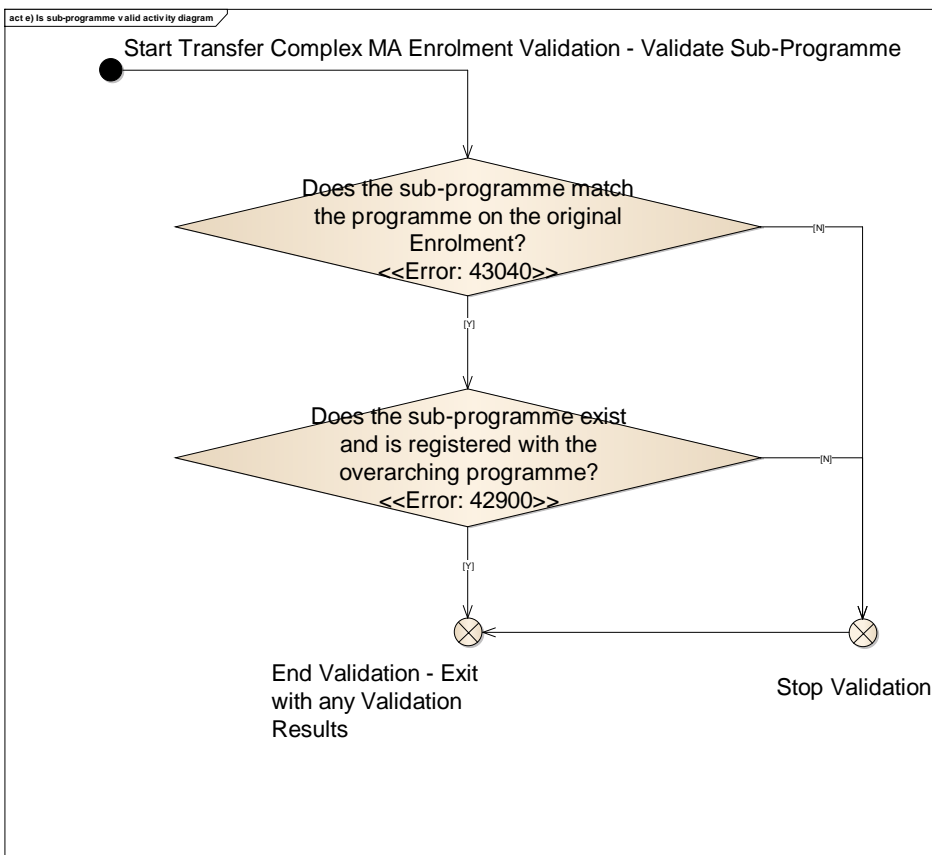

f. Are sub-programme enrolment dates valid?

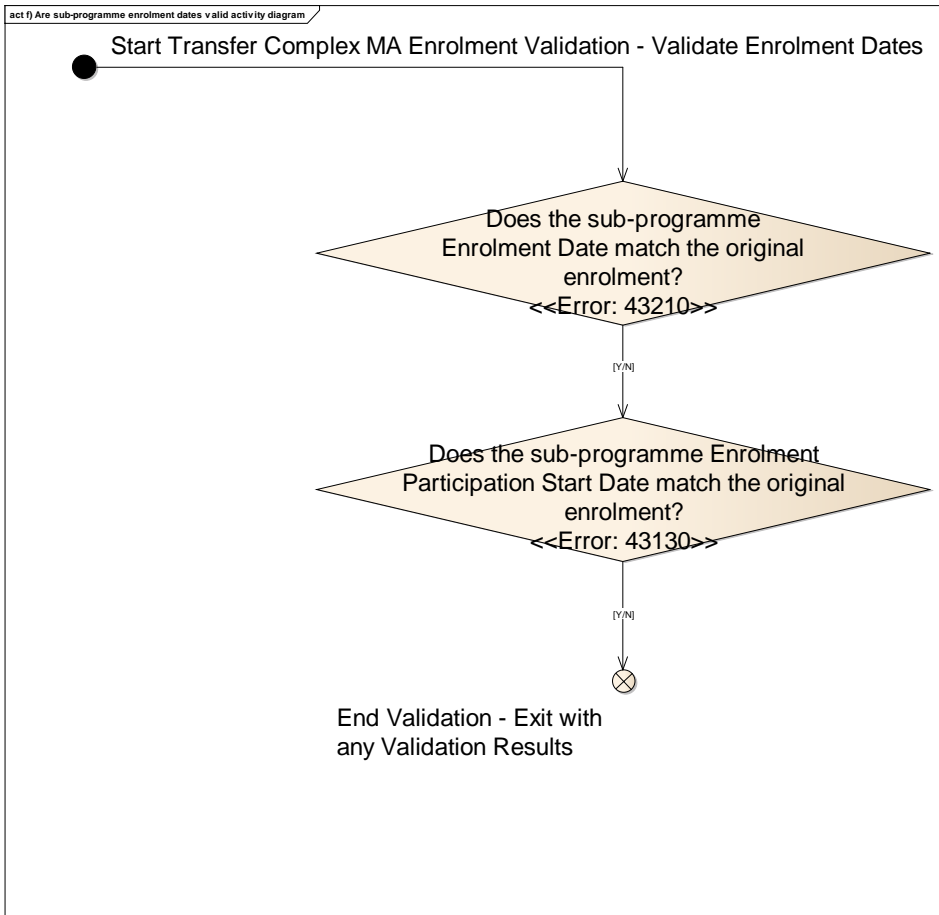

- g. Are sub-programme enrolment unit standards valid and any additional unit standards valid?

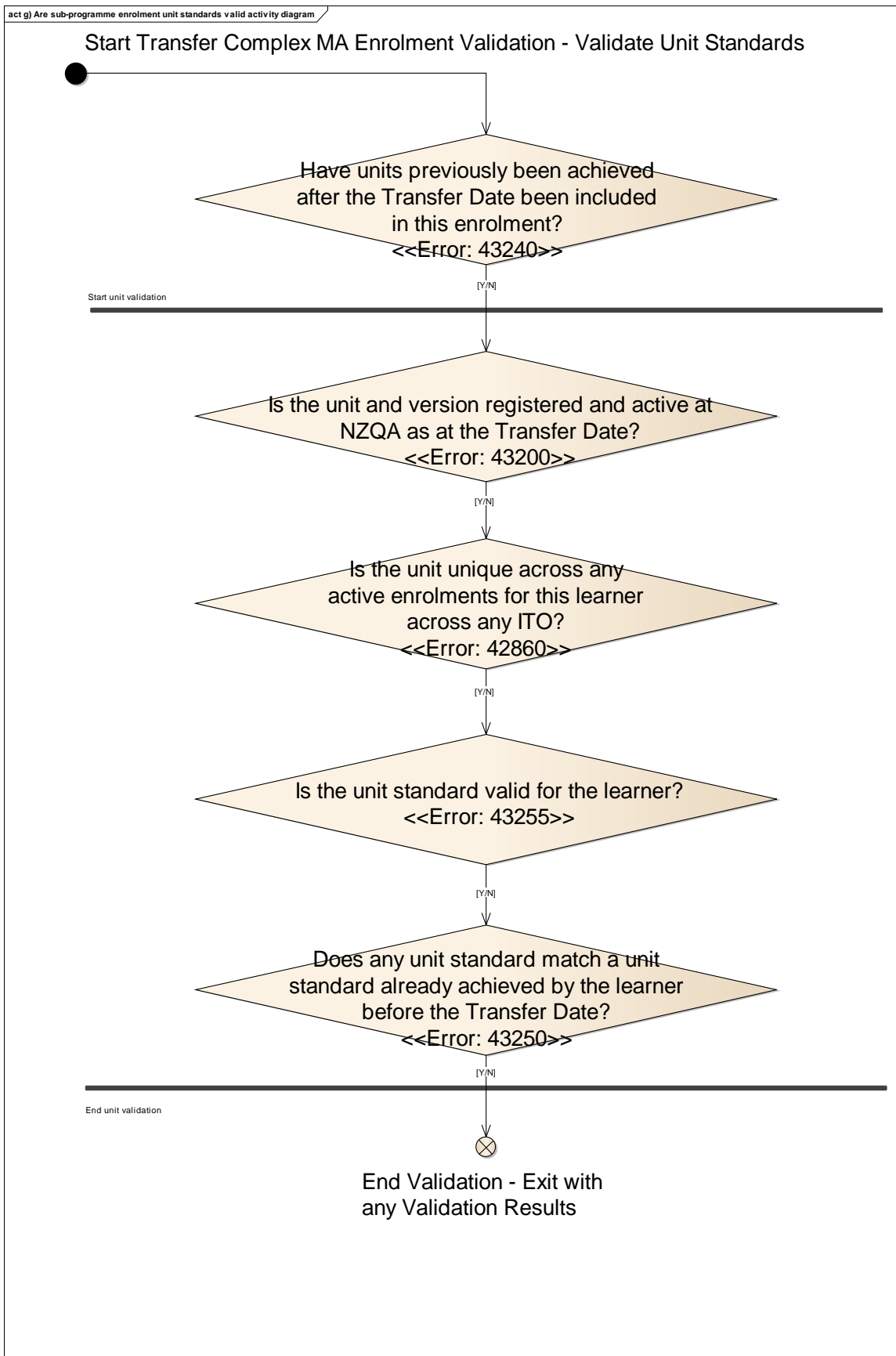

h. Are additional standards valid?

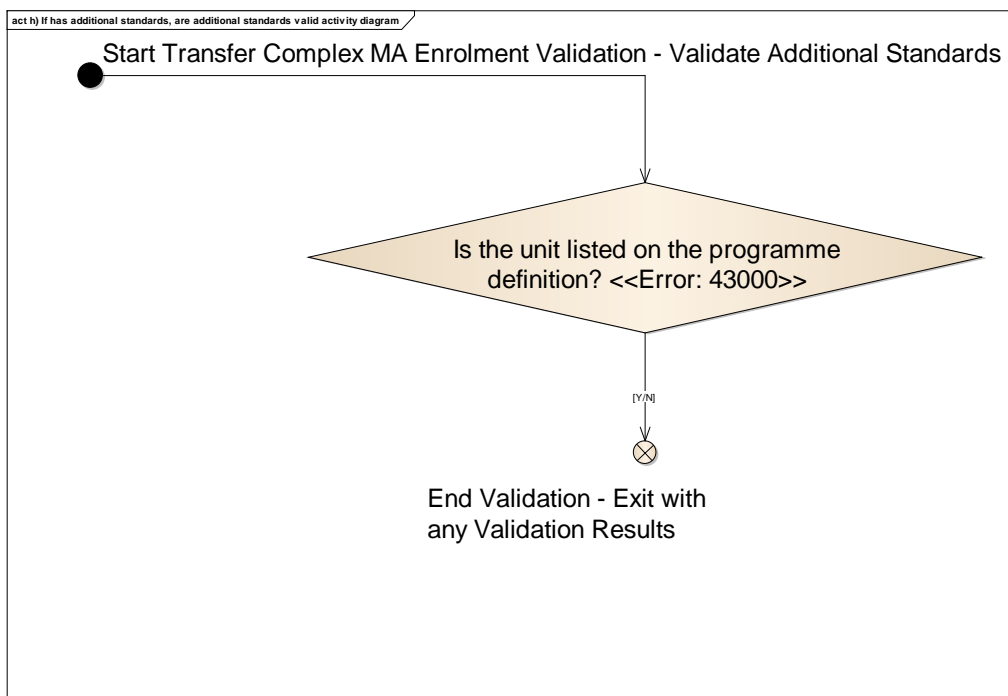

5.23.4 Business rules

The following business rules are applied if the Update Complex MA or NZA Programme Enrolment details are valid:

ID	Rule Description
1	<p>The following element are updatable in the Transfer Programme Course Version for Complex MA or NZA Programme Enrolment message:</p> <ul style="list-style-type: none"> • Overarching programme Programme Course Identifier • Sub-programme Programme Course Identifier • (sub-programme) Unit Standard • Additional Standard
2	<ul style="list-style-type: none"> • ITR will create history records to capture the changes – refer to Section 7.7 <ul style="list-style-type: none"> ○ Create the transfer programme course version event and associate the transfer programme course version event with the original and new (transferred) enrolment

5.24 Delete Programme Enrolment (E30)

Allow ITOs to delete a previously submitted programme enrolments

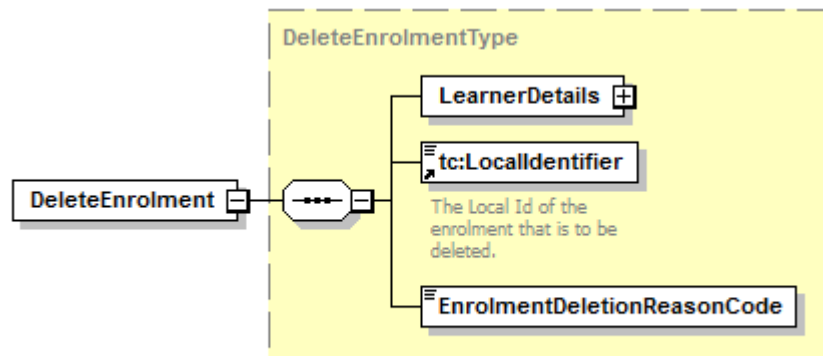

Generated by XMLSpy

www.altova.com

The table below describes the elements in this message in more detail

Element name	Cardinality	Data type	Description						
LearnerDetails	1	Complex	See section 4.2 for details.						
LocalIdentifier	1	Identifier Type	<p>A string that uniquely identifies the enrolment in a programme. Should be different from the training agreement LocalIdentifier.</p> <p>Validation</p> <p>Must match an enrolment that belongs to the learner as identified in LearnerDetails and for the ITO that submitted the message.</p> <p>The enrolment identified must not be a sub-enrolment of a Complex Apprenticeship Enrolment – to remove a Complex enrolment, specify the overarching enrolment local id.</p> <p>The enrolment participation start date has to be within the same calendar year or before March 31st of the following calendar year that the deletion message has been received</p> <p>Previously deleted enrolments cannot be re-deleted using this functionality</p>						
EnrolmentDeletion Reason	1	Code Type	<table border="1"> <thead> <tr> <th>Value</th> <th>Description</th> </tr> </thead> <tbody> <tr> <td>ID</td> <td>Programme enrolment contained an incorrect participation start date</td> </tr> <tr> <td>IE</td> <td>Programme enrolment was invalid</td> </tr> </tbody> </table>	Value	Description	ID	Programme enrolment contained an incorrect participation start date	IE	Programme enrolment was invalid
Value	Description								
ID	Programme enrolment contained an incorrect participation start date								
IE	Programme enrolment was invalid								

Element name	Cardinality	Data type	Description				
			<table border="1"> <tr> <td>IS</td> <td>Programme enrolment has incorrect status in ITR</td> </tr> <tr> <td>OT</td> <td>Other</td> </tr> </table>	IS	Programme enrolment has incorrect status in ITR	OT	Other
IS	Programme enrolment has incorrect status in ITR						
OT	Other						

Validation Rules

Delete Programme Enrolment cannot be used for programme enrolments where a deletion and subsequent re-submission will not be permitted due to normal validation rules. This is subject to the following checks e.g.

- Not allowing concurrent enrolments in two MA's or NZA's at the same time (no-withdrawn and non-completed enrolments).
- An LCP that leads to and is linked to an NQ. The LCP cannot be accepted if the NQ is in progress. If the LCP is deleted the ITR will not permit it to be created again.
- Unit Standard must be unique across all enrolments for a given learner
- Concurrent enrolments in the same programme for the same learner (any version)

NOTES:

This validation rule is applied in order to ensure that Programme Enrolments are not deleted in error without the ability to resubmit them.

If the 43490 'Enrolment cannot be deleted because it cannot be readded back into ITR' validation failure message is returned, it will be returned with the accompanying validation failures that re-adding the same enrolment would have triggered. See rules above.

5.24.1 Validation flow diagram

Delete Programme Enrolment activity diagram

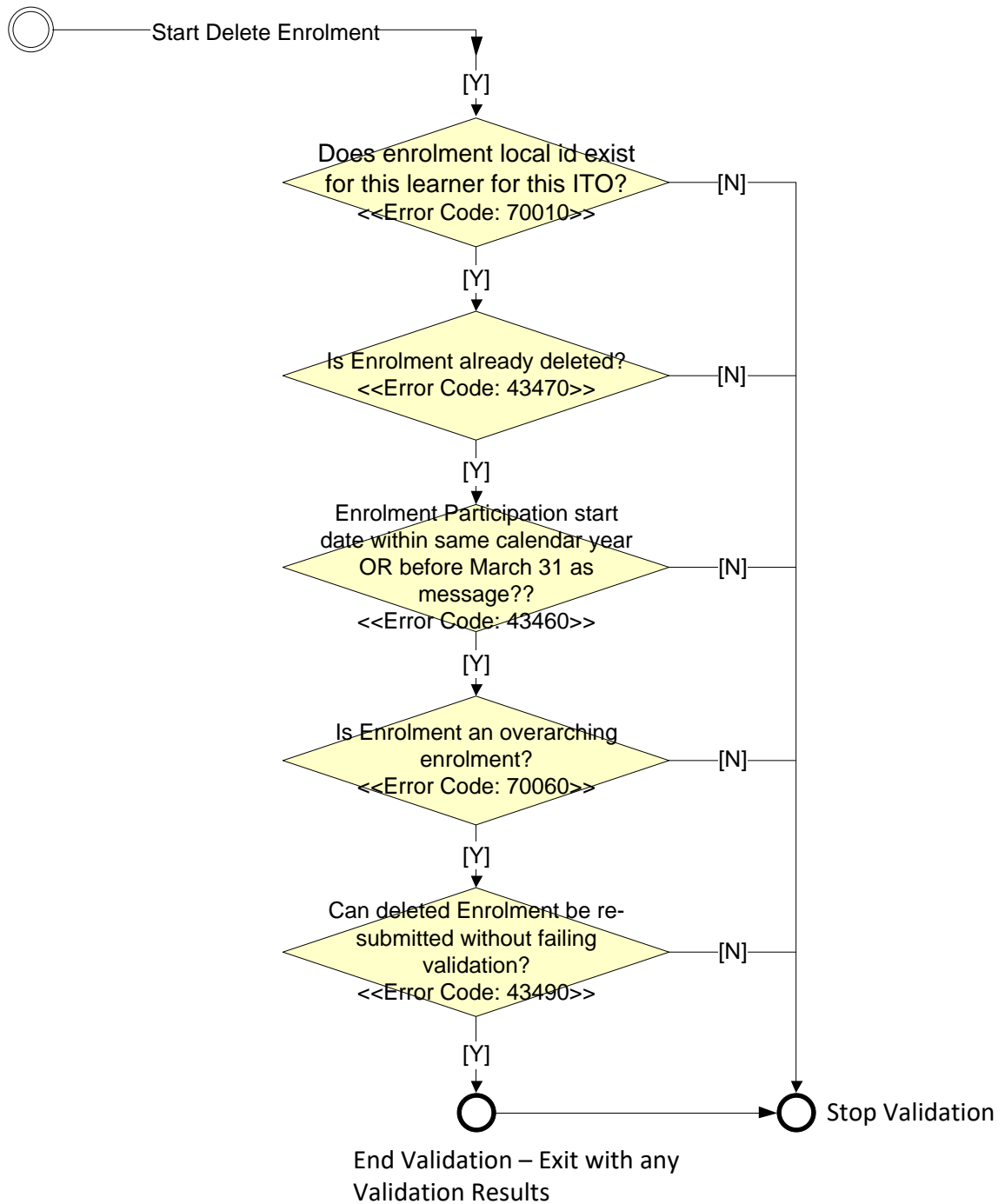

5.24.2 Business rules

ID	Rule Description
1	There will be no Data-fixes to un-delete programme enrolments once they are 'DELETED'
2	This only covers deleted programme enrolments and not the associated Training Agreements and/or plans.
3	Where there are completed unit standards against the programme enrolment that is to be deleted, it will be the ITO's responsibility to attach these to the new programme enrolment (provided that the new enrolment's participation start date is prior to the unit standards assessment date)

6 Fetch tertiary performance data

The purpose of the Fetch Tertiary Performance Data message is to enable the ITO to retrieve the **current** information held within the ITR for a specified training agreement or enrolment. This allows the ITO to check that the information held by the ITR is consistent with that held within their trainee management system. Please note that historical details of the training agreement or enrolment are not included in the return data.

The diagram below shows the high level enrolment lifecycle of an enrolment for a learner.

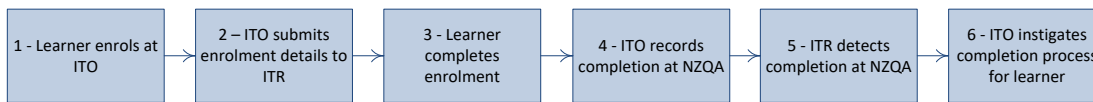

At Step 6, where the ITO instigates the completion process, the ITO may discover that the ITR does not consider the enrolment complete even though the ITO has informed NZQA of the completion. This can happen for a number of reasons, including a delay in the completion being recorded at NZQA (for the ITR to detect) or timing of the ITR nightly completion batch process.

The ITO can use the Fetch Tertiary Performance Data request message to request the details of a training agreement and associated enrolments or an individual enrolment. These details include the status and last updated dates of the training agreement, enrolment(s) and status and achieved date for unit standards. The ITO will be able to see where the discrepancies lie which are preventing completion which can inform their investigation.

The data returned in the message is also useful in general for the ITO to see other training agreement and enrolment information held by the ITR.

The request and response messages are different from the other messages in the ITR as instead of the ITOs submitting information to the ITR, the ITR will be supplying information back to the ITO.

6.1 Fetch tertiary performance data request

This message allows ITOs to request the training agreement (and associated enrolment) details or individual enrolment details held on the ITR for a specified learner and training agreement or enrolment.

The diagram below describes the elements of the Fetch Tertiary Performance Data request.

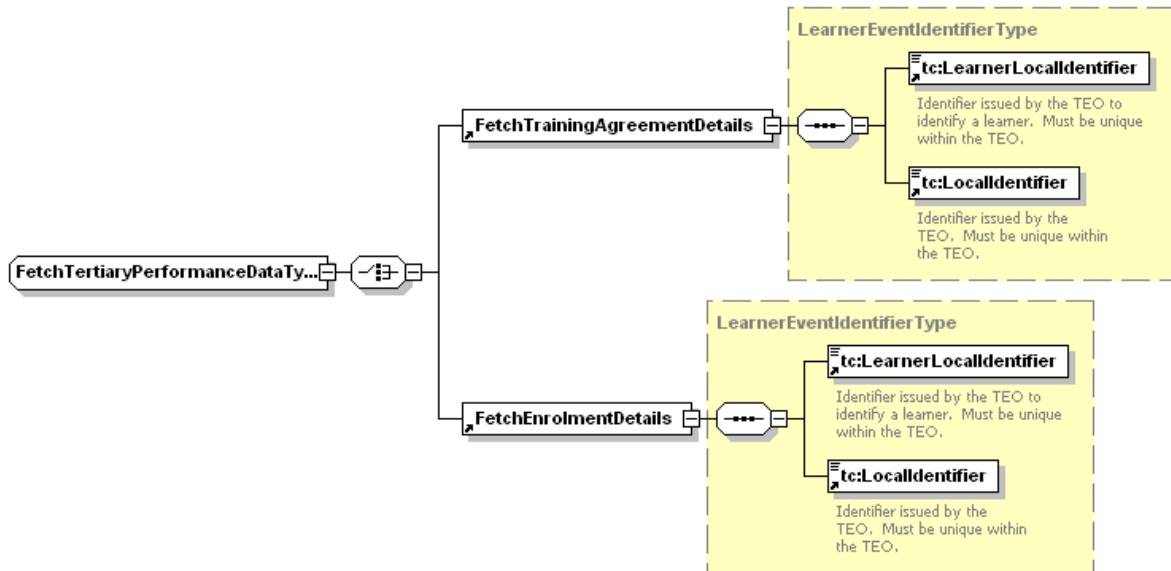

Generated with XMLSpy Schema Editor www.altova.com

The table below describes the elements in the diagram in more detail.

Element name	Cardinality	Data type	Description
FetchTraining AgreementDetails	1	Complex	Details of the specific training agreement details being requested.
LearnerLocal Identifier	1	Number Type	A unique number issued by the ITO that identifies a learner. Validation: 1 Must match a Learner Local Identifier that is associated with the ITO that submitted the message.
LocalIdentifier	1	Identifier Type	An identifier issued by the ITO that uniquely identifies the Training Agreement to the ITO. Validation: 1 Must match a training agreement that belongs to the learner as identified by the Learner Local Identifier and for the ITO that submitted the message.
FetchEnrolment Details	1	Complex	Details of the specific enrolment details being requested.
LearnerLocal Identifier	1	Number Type	A unique number issued by the ITO that identifies a learner. Validation:

Element name	Cardinality	Data type	Description
			1 Must match a Learner Local Identifier that is associated with the ITO that submitted the message.
Local Identifier	1	Identifier Type	<p>An identifier issued by the ITO that uniquely identifies the Enrolment to the ITO.</p> <p>Validation:</p> <p>1 Must match an enrolment that belongs to the learner as identified by the Learner Local Identifier and for the ITO that submitted the message.</p>

Refer to Section 6.2 for details of what the ITR returns back to the ITO if this request is successful.

6.1.1 Validation flow diagram

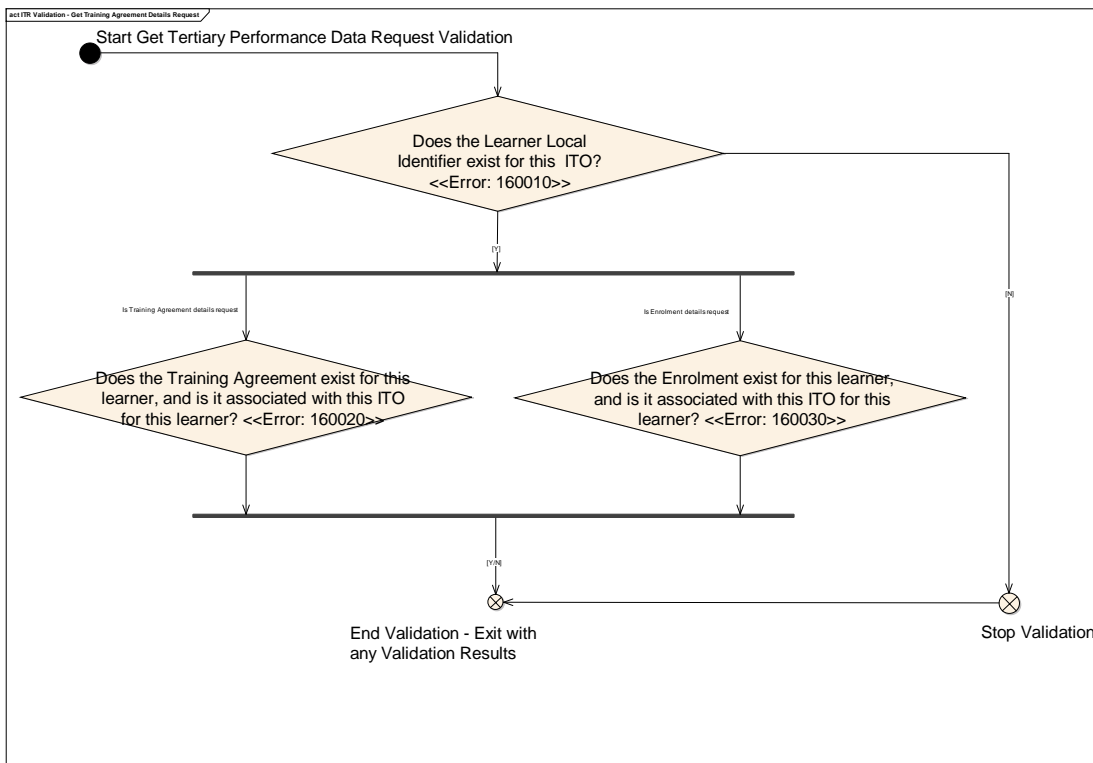

6.2 Fetch tertiary performance data response

This message is what the ITR sends back to the ITO in response to the successful processing of the Fetch Tertiary Performance Data request (refer to Section 6.1 for details of this message).

The diagram below describes the elements of the Fetch Tertiary Performance Data response.

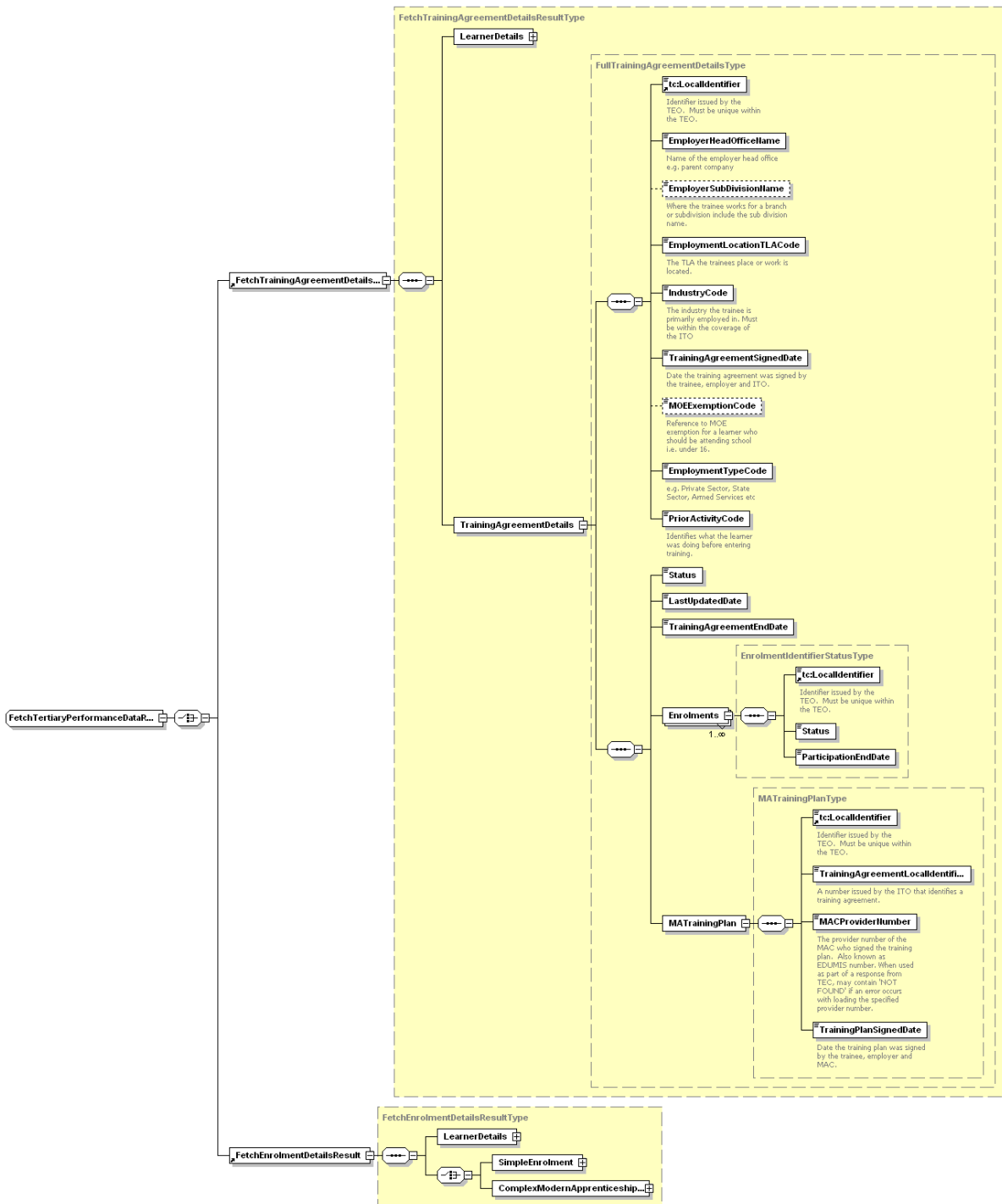

Generated with XMLSpy Schema Editor www.altova.com

Depending on the request, the training agreement details or enrolment details will be returned. These details are described in Sections 6.2.1 and 6.2.2 respectively.

6.2.1 Fetch training agreement details response

This component of the response message contains the details of the training agreement requested.

This allows the ITO to see what training agreement details and associated enrolment status details are held on the ITR for a specified learner and training agreement.

The elements required are described in more detail in the table below:

Element name	Cardinality	Data type	Description
LearnerDetails	1	Complex	See section 4.2 for details. Please note that some of the learner details may have been updated by another ITO if the learner has enrolled with them with different details. The most recent details are returned here.
TrainingAgreementDetails	1	Complex	Training agreement details.
LocalIdentifier	1	Identifier Type	See section 5.5 for details.
EmployerHeadOfficeName	1	NameType	See section 5.5 for details.
EmployerSubDivisionName	0..1	NameType	See section 5.5 for details.
EmploymentLocation TLACode	1	CodeType	See section 5.5 for details.
IndustryCode	1	CodeType	See section 5.5 for details.
TrainingAgreementSignedDate	1	DateType	See section 5.5 for details.
MOEExemptionCode	0..1	xs:string	See section 5.5 for details.
EmploymentTypeCode	1	CodeType	See section 5.5 for details.
PriorActivityCode	1	CodeType	See section 5.5 for details.
Status	1	CodeType	The status of the training agreement.
LastUpdatedDate	1	DateType	The date the training agreement was last updated.
TrainingAgreementEndDate	1	DateType	The date the training agreement was finished.
Enrolments	1..n	Complex	
LocalIdentifier	1	Identifier Type	The local identifier of the enrolment. See section 5.5.4 for details.

Element name	Cardinality	Data type	Description
Status	1	CodeType	The status of the simple or complex MA or NZA enrolment.
Participation EndDate	1	DateType	The date the enrolment was completed.
MATrainingPlan	1	Complex	As defined by section 5.16. The latest training plan for the complex MA or NZA enrolment.
LocalIdentifier	1	Identifier Type	See section 5.16 for details.
Training Agreement LocalIdentifier	1	Identifier Type	See section 5.16 for details.
MACProvider Number	1	Number Type	See section 5.16 for details. If this cannot be found in TCM, the value "NOT FOUND" will be returned for this element.
TrainingPlan Signed Date	1	DateType	The date the training plan was signed between the apprentice, employer and MAC.

6.2.2 Fetch enrolment details response

This component of the response message contains the details of the enrolment requested.

This allows the ITO to see what enrolment details are held on the ITR for a specified learner and enrolment.

The enrolment details request will either be for a Simple Enrolment or a Complex MA or NZA Enrolment as detailed in the following sections.

6.2.2.1 Simple enrolment

The purpose of this portion of the Fetch Tertiary Performance Data response message is to provide details of the simple enrolment(s) associated with the training agreement. Please refer to Section 6.2.2.2 for the details of Complex Modern Apprenticeship Programmes enrolments.

The diagram below describes the elements of a Simple Enrolment for the Fetch Tertiary Performance Data response:

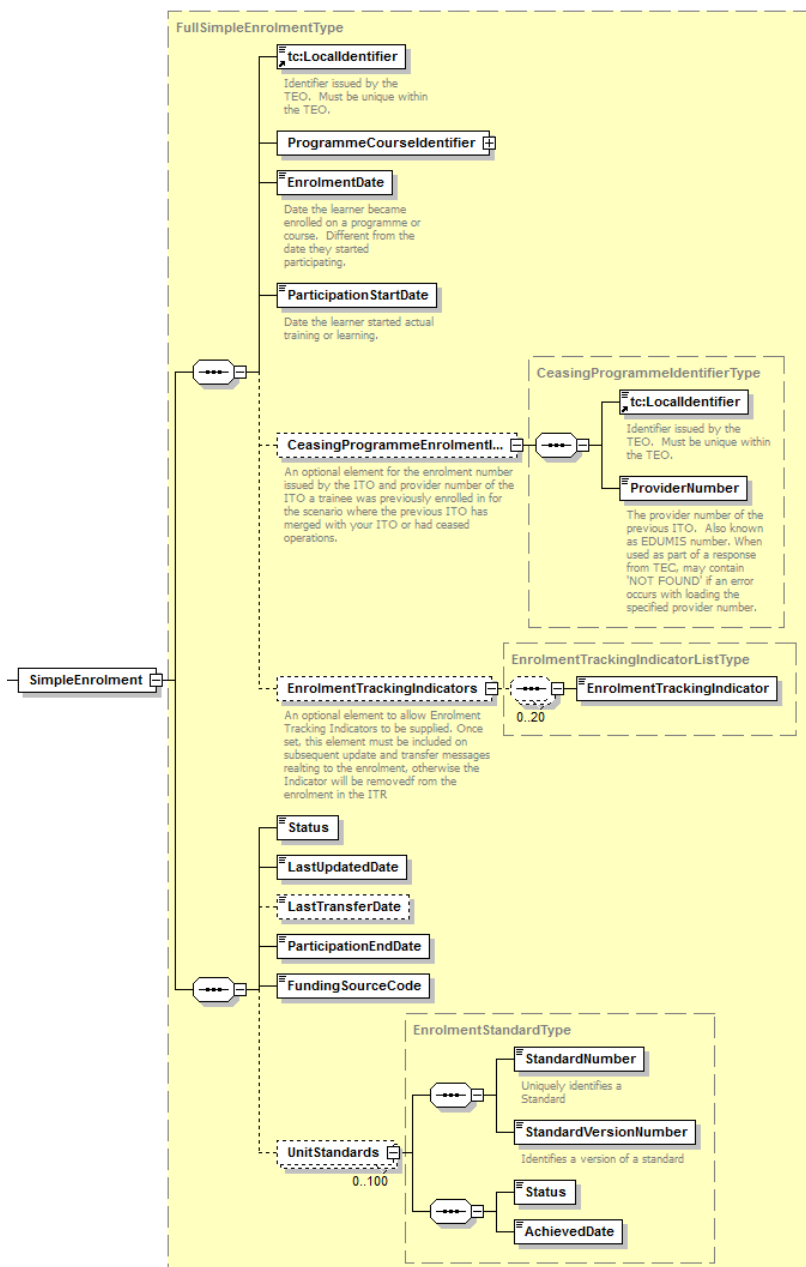

The table below describes each element in more detail. Note that these are the same elements as for SimpleEnrolment with the addition of the Status, LastUpdatedDate and ParticipationEndDate elements for the enrolment and the Status and AchievedDate for each Unit Standard:

Element name	Cardinality	Data type	Description
LocalIdentifier	1	Identifier Type	See section 5.5.4 for details.
ProgrammeCourse Identifier	1	Complex	See section 5.5.4 for details.
EnrolmentDate	1	DateType	See section 5.5.4 for details.
ParticipationStart Date	1	DateType	See section 5.5.4 for details.
Status	1	CodeType	The status of the enrolment. If the enrolment is for a sub-programme of a complex MA or NZA then this is the status of the sub-programme enrolment.
LastUpdatedDate	1	DateType	The date the enrolment was last updated. Note: If this is a sub-programme enrolment of a complex MA or NZA, this will be the date the sub-programme enrolment was last updated.
LastTransferDate	1	DateType	See section 5.22 for details. Note: If there has been no previous TransferSimpleProgrammeCourseVersion message for this enrolment, there will be no LastTransferDate.
ParticipationEnd Date	1	DateType	The date the enrolment was completed.
FundingSource Code	1	CodeType	See section 5.5.4 for details.
UnitStandards	1..100	Complex	
StandardNumber	1	Number Type	See section 4.5 for details.
StandardVersion Number	1	Number Type	See section 4.5 for details.
Status	1	CodeType	The status of the unit standard. If the standard (and version) in the enrolment match a standard at NZQA on the learner's RoA and the success_ind = true then the status will be set to "Complete" otherwise the status will be set to "To be completed".
AchievedDate	1	DateType	If the unit standard (and version) is on the learner's RoA as completed, this will be the date_completed.

Element name	Cardinality	Data type	Description
			Please note that if the standard (and version) has been achieved more than once then this date will be the most recently achieved date.
CeasingProgrammeEnrolmentIdentifier	0..1	Complex	See section 4.6 for details The enrolment details at the ceasing ITO
EnrolmentTrackingIndicator	0..20	Complex	See section 4.7 for details The Enrolment Tracking Indicator codes that have been set on the enrolment

6.2.2.2 Complex modern apprenticeship enrolment

The purpose of this portion of the Fetch Tertiary Performance Data response message is to provide details of the complex modern apprenticeship enrolment associated with the training agreement. Please refer to Section 6.2.2.1 for the details of simple enrolments.

The diagram below describes the elements of a Complex MA or NZA Enrolment for the Fetch Tertiary Performance Data Response:

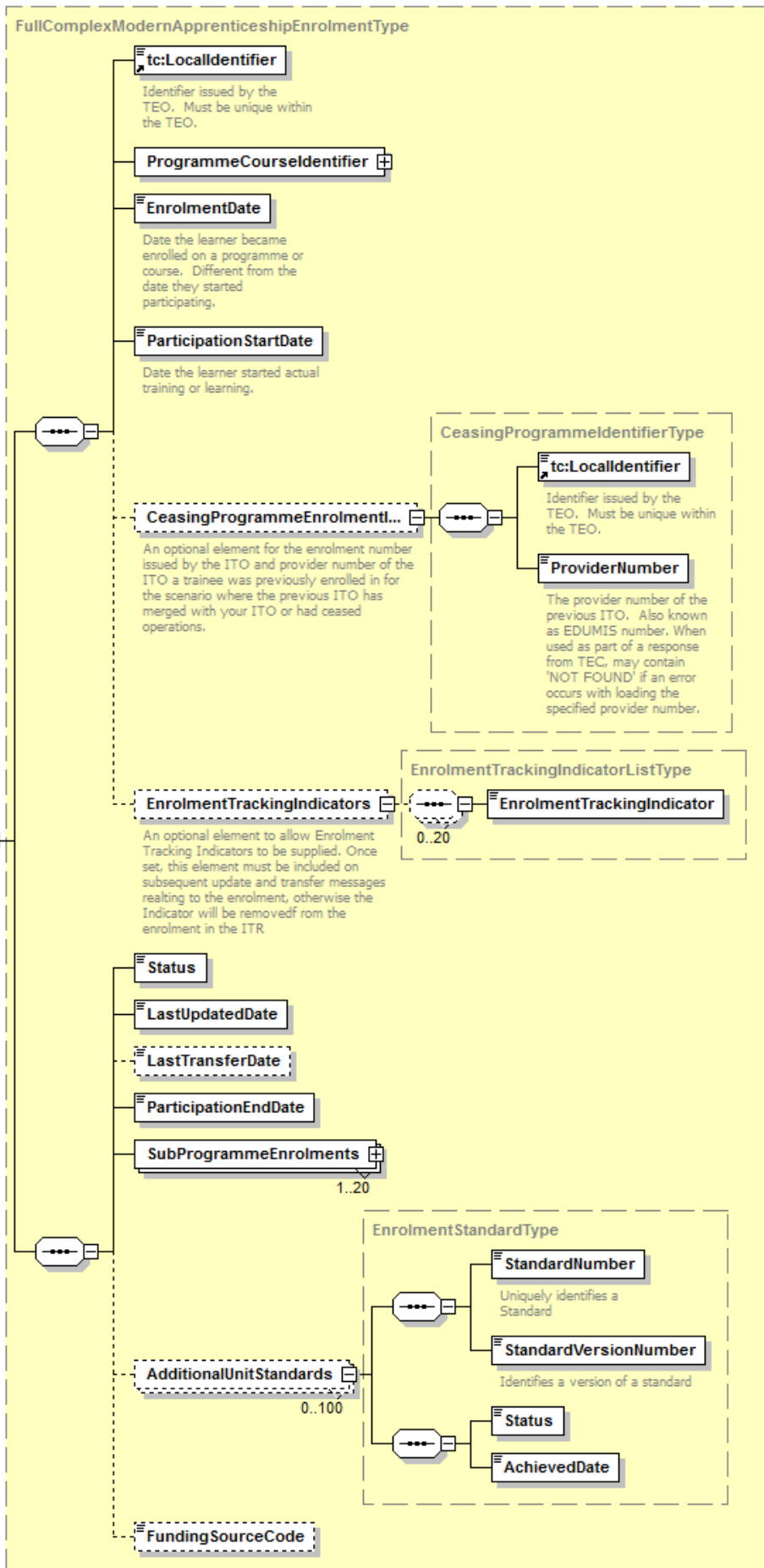

The table below describes each element in more detail. Note that these are the same elements as for ComplexModernApprenticeshipEnrolment with the addition of the Status, LastUpdatedDate and ParticipationEndDate elements for the enrolment, the Status and AchievedDate for each Additional Standard:

Element name	Cardinality	Data type	Description
LocalIdentifier	1	Identifier Type	See section 5.5.7 for details.
ProgrammeCourse Identifier	1	Complex	See section 5.5.7 for details.
EnrolmentDate	1	DateType	See section 5.5.7 for details.
ParticipationStart Date	1	DateType	See section 5.5.7 for details.
Status	1	CodeType	The status of the enrolment. This is the status of the overarching programme enrolment. Note: Each of the sub-programme enrolments will have their own statuses.
LastUpdatedDate	1	DateType	The date the overarching programme enrolment was last updated.
LastTransferDate	1	DateType	See section 5.23 for details. Note: If there has been no previous TransferComplexModernApprenticeship-ProgrammeCourseVersion message for this enrolment, there will be no LastTransferDate.
SubProgramme Enrolments	1..20	Complex	Details of the sub-programme enrolment(s). The structure of this element is the same as for a simple enrolment. See section 6.2.2.1 for details.
ParticipationEnd Date	1	DateType	The date the enrolment was completed.
Additional Standards	0..100	Complex	See section 5.5.7 for details.
StandardNumber	1	Number Type	See section 4.5 for details.
StandardVersion Number	1	Number Type	See section 4.5 for details.
Status	1	CodeType	The status of the unit standard. If the standard (and version) in the enrolment match a standard at NZQA on the learner's RoA and the success_ind = true then the status will be set to "Complete" otherwise the status will be set to "To be completed".

Element name	Cardinality	Data type	Description
AchievedDate	1	DateType	<p>If the unit standard (and version) is on the learner's RoA as completed, this will be the date_completed.</p> <p>Please note that if the standard (and version) has been achieved more than once then this date will be the most recently achieved date.</p>
CeasingProgramme EnrolmentIdentifier	0..1	Complex	<p>See section 4.6 for details</p> <p>The enrolment details at the ceasing ITO</p>
EnrolmentTrackingI ndicator	0..20	Complex	<p>See section 4.7 for details</p> <p>The Enrolment Tracking Indicator codes that have been set on the enrolment</p>

7 ITR processing

7.1 Introduction

The purpose of this section is to describe processing that is initiated by the ITR directly rather than via an ITO TMS sending a message to the ITR. TMS vendors and ITOs should understand the processing described here and the implications this will have on data held within the TMS.

7.1.1 Order of processing

The overnight processes are expected to run in this order:

1. ETL (Extract, Transform and Load) of NZQA data from NZQA to TEC
2. Complete enrolment via RoA
3. Grace period expiry

Other points to note:

- If one process fails, the next process will still run independently.
- The Complete enrolment via RoA process and Grace period process may run while the ETL is taking place (they do not need to wait for the ETL to complete).
- The Grace period expiry process must wait for the Complete enrolment via RoA process to complete (regardless of whether or not it completes successfully). The Complete enrolment via RoA process and Grace period process cannot run at the same time, as they both end enrolments and training agreements, and this may result in conflicting updates.
- TEC will be able to schedule the Complete enrolment via RoA process and Grace period processes. TEC can monitor when these processes were last run.

7.2 Complete enrolment via RoA

The method by which ITOs notify the TEC of successful completion of enrolments has changed with the introduction of the ITR. ITOs are already required to report achievement of unit standards and NQF based qualifications to NZQA. With the introduction of the ITR the TEC will no longer require ITOs to also report achievement of qualifications and standards to the TEC. Instead the ITR will detect completion of a programme when the relevant information is supplied by the ITO to NZQA and it is recorded against the learner's RoA.

Important Note: A qualification completion that occurs before the enrolment participation start date will not trigger an enrolment completion as the qualification has previously been achieved by the learner.

7.2.1 Detecting Enrolment Completions

1. NQ programme enrolments (not at a status of Pending (if MA or NZA), Withdrawn or Completed) are to be completed when both the target qualification and all unit standards for the enrolment have been achieved, where the achieved date (at RoA) \geq enrolment participation start date.
 - a. If the NQ programme has a target qualification with a strand, the check will be done against the specified strand.

- b. If the NQ programme has a target qualification without a strand, the check will be done against the qualification (either with no strand at all, or with any strand)
- 2. LCP programme enrolments (not at a status of Withdrawn or Completed) are to be completed when all unit standards for the enrolment have been achieved, where the achieved date (at RoA) is \geq enrolment participation start date.
- 3. SCP programme enrolments (not at a status of Withdrawn or Completed) are to be completed when all unit standards for the enrolment (and target qualification if it exists with a strand if it exists) have been achieved, where the achieved date (at RoA) is \geq enrolment participation start date.
- 4. Complex MA or NZA programme enrolments (not at a status of Pending, Withdrawn or Completed) are to be completed when all sub-programme enrolments (see 1a above for NQ completion criteria) and all additional unit standards for the enrolment have been achieved for units, where the achieved date (at RoA) \geq enrolment participation start date.

7.2.2 Completing an Enrolment

- 1. When an NQ, LCP or SCP programme enrolment has been identified as completed, then:
 - a. Create a learner event history record to capture changes to the enrolment - refer to section 7.7.
 - b. Update the enrolment status to Completed.
 - c. Update the enrolment actual end date to the latter date of the date the qualification was achieved (if qualification exists) or the date the last standard was achieved.
 - d. Create a completion event.
- 2. When a Complex MA or NZA enrolment has been identified as completed, then:
 - a. Create a learner event history record to capture changes to the enrolment - refer to section 7.7.
 - b. Update the overarching programme enrolment status to Completed.
 - c. Update the overarching enrolment participation actual end date to the latter date of the latest sub-programme enrolment participation actual end date or the date the last additional standard was achieved.
 - d. Create a completion event.

7.2.3 Completing a Training Plan

- 1. For simple MA or NZA enrolments where the enrolment status has been updated to Completed:
 - a. Record learner event history for changes to the training plan - refer to section 7.7.
 - b. Update the training plan end date to the enrolment participation actual end date.
- 2. For complex MA or NZA enrolments where the enrolment status of the overarching programme enrolment has been updated to Completed:
 - a. Record learner event history for changes to the training plan - refer to section 7.7.

- b. Update the training plan end date to the overarching programme enrolment participation actual end date.

7.3 Grace Period Expiry

The ITR will use a nightly batch process to detect when the Grace Period has expired. If the Grace Period has expired on a Training Agreement, then all of its Enrolments that are not already Completed or Withdrawn will be Withdrawn, and the Training Agreement will be Finished.

7.3.1 Withdrawal reason for Grace Period Expiry

A new withdrawal reason will be added:

- “GE” – “Grace period automatically expired by system”

This withdrawal reason will be used for all Training Agreements and Enrolments withdrawn via the overnight process.

This withdrawal reason will be added to the look up table in the database, however it will be excluded from the list of allowed values for the Withdraw Training Agreement and Withdraw Enrolment messages in the schema, as this withdrawal reason may only be set by the system.

7.3.2 Processing

The overnight Grace Period Expiry process will work as follows:

For all training agreements with a status of “Grace” where the training agreement end date <= the grace period expiry batch processing date (i.e. today’s date), then

- a. Update the training agreement:
 - i. Record learner event history for changes to the training agreement - refer to section 7.7.
 - ii. Update the training agreement status to “Finished”
 - iii. Create a Withdraw Training Agreement event, with the withdrawal reason code = “GE”
- b. Update the associated enrolments whose statuses are not “Completed” or “Withdrawn”:
 - i. Create a learner event history record to capture changes to the enrolment - refer to section 7.7.
 - ii. Update the actual participation end date of the enrolment to the training agreement end date
 - iii. Create a Withdraw Enrolment event, with the withdrawal reason code = “GE”
 - iv. Note that for complex MA or NZA, these updates listed above apply to the overarching programme enrolment and each of the sub-programme enrolments.
- c. If expiring a training agreement for a complex MA or NZA, and a current training plan exists, then:
 - i. Update the current training plan end date to the training agreement end date

The Grace Expiry job will most likely run once a day, during the early hours of the morning. This means that if there are any Training Agreements with a status of "Grace" where the training agreement end date is today's date, they will be expired at the start of that day (not at the end of the day).

7.4 Tertiary Contact Management system (TCM)

TEC stores a unique ID for every organisation which it deals with. This must be sourced and saved into ITR for reference.

7.5 Learner history

The Learner History captures changes that have been made to the Learner record. A Learner History record is a copy of all the details contained in the Learner record regardless of which details have been changed. This includes changes to all components of the Learner record i.e changes to the Learner Identity, Demographics and Education History.

When a learner is first created, the equivalent Learner History record will be created as the baseline history record.

When a learner event occurs, ITR will check if the learner's details have changed. If so, the learner's details will be updated (if valid) and a Learner History record will be created. This will make it possible to recreate the learner details as they were supplied in the message. Refer to Section 4.2 for Learner record validation rules.

7.6 Learner event

A learner event is an event such as an enrolment creation, training agreement update, etc that occurs against a learner.

Each time a learner event message is received from an ITO, a Learner Event record is created against the Learner record and the associated Learner History record.

7.7 Learner event history

The Learner Event History records changes to any events that occur against a learner. The baseline Learner Event History record is created when the event is initially created e.g. the first time an enrolment is submitted for the learner.

Every message that gets sent by the ITO, excluding programme specific items, will need a Learner Event History record created for it.

7.8 Documentation

The following documentation will be produced for the ITR:

- IT Help Desk - how to set this system up/add users etc
- Application Overview –
- Operations Document - know how to build servers etc
- EA Model -

8 Appendices

8.1 Programme course naming convention

Note: This section does not impact ITOs and will be used by the TEC for internal purposes only.

TEC will refer to programmes using a generated name constructed as follows:

- [ITO Name] + ["Programme Type⁸] +
- "leading to " / "in " [NQF Qualification Name] +
- "version " [NQF Qualification Version] +
- "level " [TEC programme Level] +
- "strand " [NQF Qualification Strand]

For example:

Agriculture Industry Training Organisation Programme leading to National Certificate in Agrichemical Supply Version 1 Level 3 Animal Health Products Strand

It is expected that generated programme name will be unique. This is not supported by any validation rules regarding one programme per ITO for each qual/strand combination (including no strand or strand '0'). For complex MA or NZA programmes with many sub-programmes there may be several NQF qualifications targeted by the different sub-programmes. It is up to the ITO to list the sub-programmes in order of importance. The name assigned to the MA or NZA will be taken from the first one listed. If several complex MAs and NZAs include the same sub-programme then please bear this in mind.

8.2 Validation business rules workflows

Note: This section does not impact ITOs and will be used by the TEC for internal purposes only.

Element name	Details
ITO Name	Legal name from TCM
Programme Type	National Qualification Programme / Modern Apprenticeship Programme / Limited Credit Programme / Supplementary Credit Programme
"leading to " / "in "	Fixed Text. "in " is only used where there is no associated NQF target programme.
NQF Qualification Name	Taken from the target NQF qualification listed against the programme. If this contains some of the details in the other fields listed below, it does not matter, all fields will be included. Over time these will cease to include the level/credits etc. Where this is a complex MA or NZA with many sub-programmes the qual associated with the first sub-programme will be listed. It is up to the ITO to list the programmes in the order of priority.

⁸ This is 'national qualification' 'modern apprenticeship' etc.

Element name	Details
	Where there is no associated target NQF qualification use “in “ plus the local programme name supplied by the ITO - the other fields below will not be required.
“version”	Fixed text
NQF Qualification Version	Taken from the target NQF qualification listed against the programme.
“level”	Fixed text
TEC Programme Level	Taken from the programme definition.
“strand”	Fixed text
NQF Qualification Strand	Taken from the target NQF qualification listed against the programme. This is the textual name of the strand. If there is no strand listed, or is the strand = 0 this means the strand does not exist. No strand will be listed (even if there is text against ‘strand 0’ at NZQA). [TO BE CONFIRMED]

Examples:

- Aviation, Tourism and Travel Training Organisation Limited Credit Programme leading to National Certificate in Airport Operations (Level 4) with strands in Airport Customer Service, Airport Maintenance, and Airport Safety Version 5 Level 4 Strand Airport Customer Service
- Electricity Supply Industry Training Organisation National Qualification Programme leading to National Certificate in Telecommunications (Level 4) with strands in Bearer and Switch; Building and Data Cabling; Customer Access Network; Customer Premises Equipment; and Radio Version 2 Level 4 Strand Building and Data Cabling
- Electricity Supply Industry Training Organisation Modern Apprenticeship Programme leading to National Certificate in Telecommunications (Level 4) with strands in Bearer and Switch; Building and Data Cabling; Customer Access Network; Customer Premises Equipment; and Radio Version 2 Level 4 Strand Customer Access network
- [Southern Institute of Technology](#) Supplementary Credit Programme leading to Certificate in Fashion and Design Version 1 Level 3
- Agriculture Industry Training Organisation Supplementary Credit Programme in Wool Handling Systems

8.3 Success codes

Transaction result code	Short description	Object identifiers	Parameters
10000	Success	For "Create Programme Course": Programme Number, Programme Version Number For "Create Programme Course Version": Programme Version Number For remaining messages: -	-

8.4 Validation errors

GENERAL PRINCIPLE: When checking for a learner, training agreement, enrolment, training plan, if it does not exist then stop and exit validation.

Note: For Complex MA or NZA, the return parameters will not specify if the programme is a programme or sub-programme, however the Programme Numbers returned will allow you to determine this in your system.

Error code	Short description	Object identifiers	Parameters
	Create programme based		
30010	Your organisation's programme identifier must be unique	Organisation Programme Identifier	Programme Number
30020	Your organisation's programme name must be unique	Organisation Programme Identifier	Last Active: Programme Course Number Programme Course Version Number Organisation Programme Name provided

Error code	Short description	Object identifiers	Parameters
30030	The terms and conditions must be accepted	Organisation Programme Identifier	nil
30040	Expiry date must be greater than or equal to the processing date	Organisation Programme Identifier	Processing Date Expiry Date
30050	Industry code must be a level 4 industry code	Organisation Programme Identifier	Industry Code provided
30060	Industry codes must be unique	Organisation Programme Identifier	Industry Code provided
30070	Funding source codes must be unique	Organisation Programme Identifier	Fund provided
30080	Historical programme numbers must be unique	Organisation Programme Identifier	Historical Programme Number provided
30090	Expiry date must be after the start date	Organisation Programme Identifier	Start Date Expiry Date
31010	LCP must be funded from IT and/or TA	Organisation Programme Identifier	Fund provided
31020	An active version of the LCP target programme could not be found for your organisation	Organisation Programme Identifier	Target Programme Number
31030	LCP Target Programme must be a National Qualification programme	Organisation Programme Identifier	Target Programme Number
31040	LCP Target Programme already has an active LCP programme	Organisation Programme Identifier	Target Programme Number
31050	LCP Programme funding source code(s) must be the same as or a subset of the funding source codes for the target programme	Organisation Programme Identifier	Target Programme Number Target Programme Version Number
31060	LCP credit value must be greater than or equal to the minimum credit value allowed	Organisation Programme Identifier	Credit Value provided
31070	LCP credit load per year must be less than or equal to the maximum credit load allowed	Organisation Programme Identifier	Credit Value provided Duration provided
31080	LCP duration must be greater than or equal to the minimum duration allowed	Organisation Programme Identifier	Duration provided
31090	LCP credit value must be less than the maximum percentage of the target programme credits	Organisation Programme Identifier	Target Programme Number Target Programme Version Number Credit Value submitted
31100	LCP credit value must be less than or equal to the maximum credit value allowed	Organisation Programme Identifier	Credit Value provided
31110	LCP standards must be unique	Organisation Programme Identifier	Unit Standard Number Unit Standard Version Number

Error code	Short description	Object identifiers	Parameters
31130	Programme unit standard must exist and have an active status at NZQA	Organisation Programme Identifier	Additional Standards NZQA Standards
32010	NQ programme credit value must be greater than or equal to the minimum credit value allowed	Organisation Programme Identifier	Credit Value provided
32020	NQ programme credit load per year must be less than or equal to the maximum credit load allowed	Organisation Programme Identifier	Credit Value provided Duration provided
32030	NQF level of an NQ programme funded by Modern Apprenticeship must be greater than or equal to the minimum NQF value allowed	Organisation Programme Identifier	NQF Level provided
32040	NQ programme funding sources are invalid	Organisation Programme Identifier	Incorrect fund source provided
32050	NQ duration must be greater than or equal to the minimum duration allowed	Organisation Programme Identifier	Duration provided
32060	Target qualification / strand must exist and have an active status at NZQA	Organisation Programme Identifier	Qualification Number Qualification Version Number Strand Number
33010	SCP must be funded from IT and/or TA	Organisation Programme Identifier	Fund provided
33020	SCP credit load per year must be less than or equal to the maximum credit load allowed	Organisation Programme Identifier	Credit Value provided Duration provided
33040	SCP credit value must be less than or equal to the maximum credit value allowed	Organisation Programme Identifier	Credit Value provided
33050	SCP credit value must be greater than or equal to the minimum credit value allowed	Organisation Programme Identifier	Credit Value provided
33060	SCP standards must be unique	Organisation Programme Identifier	Unit Standard Number Unit Standard Version Number
33070	SCP duration must be greater than or equal to the minimum duration allowed	Organisation Programme Identifier	Duration provided
33080	Target qualification / strand must exist and have an active status at NZQA	Organisation Programme Identifier	Qualification Number Qualification Version Number Strand Number NZQA Qualification
33090	Programme unit standard must exist and have an active status at NZQA	Organisation Programme Identifier	Additional Standards NZQA Standards
34010	MA or NZA NQF level must be greater than or equal to the minimum NQF value allowed	Organisation Programme Identifier	NQF Level provided

Error code	Short description	Object identifiers	Parameters
34020	MA or NZA with sub-programmes must have a credit load per year that is less than or equal to the maximum credit load allowed	Organisation Programme Identifier	Credit Value provided Duration provided
34030	MA or NZA with sub-programmes must be funded by Modern Apprenticeship	Organisation Programme Identifier	Fund provided
34040	MA or NZA with sub-programmes must have a credit value greater than or equal to the minimum credit value allowed	Organisation Programme Identifier	Credit Value provided
34050	Sub-programmes must be unique	Organisation Programme Identifier	Sub programme number
34060	Additional standards must be unique	Organisation Programme Identifier	Unit Standard Number Unit Standard Version Number
34070	Complex MA or NZA duration must be greater than or equal to the minimum duration allowed	Organisation Programme Identifier	Duration provided
34080	Sub-programme cannot be found	Organisation Programme Identifier	Sub Programme Number Sub Programme Version Number
34090	Complex MA or NZA with one sub-programme must also supply additional units	Organisation Programme Identifier	n/a
34120	Programme unit standard must exist and have an active status at NZQA	Organisation Programme Identifier	Additional Standards NZQA Standards
Create programme version based			
50010	Programme cannot be found	Organisation Programme Identifier, Programme Number	n/a
50020	Your organisation's programme identifier does not match that already stored for this programme	Organisation Programme Identifier, Programme Number	n/a
50030	Terms and Conditions must be accepted	Organisation Programme Identifier, Programme Number	n/a
50040	Expiry date must be greater than or equal to processing date (ie today's date)	Organisation Programme Identifier, Programme Number	Processing Date Expiry Date
50060	Programme Industry Codes Must Be Unique	Organisation Programme Identifier, Programme Number	Industry Code

Error code	Short description	Object identifiers	Parameters
50070	Programme Funding Source Codes Must Be Unique	Organisation Programme Identifier, Programme Number	Fund
50080	Historical programme numbers must be unique	Organisation Programme Identifier, Programme Number	Historical Programme Number
51010	LCP must be funded from IT and/or TA	Organisation Programme Identifier, Programme Number	Fund provided
51020	An active version of the LCP target programme could not be found for your organisation	Organisation Programme Identifier	Target Programme Number
31030	LCP Target Programme must be a National Qualification programme	Organisation Programme Identifier	Target Programme Number
31050	LCP Programme funding source code(s) must be the same as or a subset of the funding source codes for the target programme	Organisation Programme Identifier	Target Programme Number Target Programme Version Number
51060	LCP credit value must be greater than or equal to minimum credit value allowed	Organisation Programme Identifier, Programme Number	Credit Value
51070	LCP credit value per year must be less than or equal to max	Organisation Programme Identifier, Programme Number	Credit Value Duration
51080	LCP duration must be greater than or equal to minimum	Organisation Programme Identifier, Programme Number	Duration
31090	LCP credit value must be less than the maximum percentage of the target programme credits	Organisation Programme Identifier	Target Programme Number Target Programme Version Number Credit Value submitted
51100	LCP credit value must be less than or equal to max	Organisation Programme Identifier, Programme Number	Credit Value
51110	LCP standards must be unique	Organisation Programme Identifier	Unit Standard Number Unit Standard Version Number
53050	SCP credit value must be greater than or equal to minimum credit value allowed	Organisation Programme Identifier, Programme Number	Credit Value
52010	NQ credit value must be greater than or equal to minimum credit value allowed	Organisation Programme Identifier, Programme Number	Credit Value

Error code	Short description	Object identifiers	Parameters
52020	NQ - credit value per year must be less than or equal to max	Organisation Programme Identifier, Programme Number	Credit Value Duration
52030	NQF level of an NQ programme funded by Modern Apprenticeship must be greater than or equal to the minimum NQF value allowed	Organisation Programme Identifier, Programme Number	NQF Level
52040	NQ programme must be funded either by Industry Training or by Industry Training and Modern Apprenticeship	Organisation Programme Identifier, Programme Number	Fund
52050	NQ duration must be greater than or equal to minimum	Organisation Programme Identifier, Programme Number	Duration
53010	SCP must be funded from IT and/or TA	Organisation Programme Identifier, Programme Number	Fund
53020	SCP credit value per year must be less than or equal to max	Organisation Programme Identifier, Programme Number	Credit Value
53030	SCP, credit value per year must be less than or equal to max	Organisation Programme Identifier, Programme Number	Credit Value Duration
53040	SCP credit value must be less than or equal to max	Organisation Programme Identifier, Programme Number	Credit Value
53050	SCP credit value must be greater than or equal to min	Organisation Programme Identifier, Programme Number	Credit Value
53060	SCP standards must be unique	Organisation Programme Identifier	Unit Standard Number Unit Standard Version Number
53070	SCP duration must be greater than or equal to minimum	Organisation Programme Identifier, Programme Number	Duration
54010	Complex MA or NZA NQF level must be greater than or equal to the minimum NQF value allowed	Organisation Programme Identifier, Programme Number	NQF Level
54020	MA or NZA - credit value per year must be less than or equal to maximum	Organisation Programme Identifier, Programme Number	Credit Value Duration

Error code	Short description	Object identifiers	Parameters
54030	Complex MA or NZA must be funded by Modern Apprenticeship	Organisation Programme Identifier, Programme Number	Funding Source
54040	Complex MA or NZA credit value must be greater than or equal to minimum credit value allowed	Organisation Programme Identifier, Programme Number	Credit Value
54060	Additional standards must be unique	Organisation Programme Identifier	Unit Standard Number Unit Standard Version Number
54070	Complex MA or NZA programme duration must be greater than or equal to minimum	Organisation Programme Identifier, Programme Number	Duration
55000	The supplied EDMUIS for the programme version is not linked in TCM	Programme Course Version Local ID, EDUMIS	EDUMIS from linked programme
55100	The programme version cannot be unlinked due to existing linked enrolments	Programme Course Version Local ID, EDUMIS	EDUMIS from linked programme, Programme Course Local ID from linked programme
55200	The linked programme has been linked to by a different programme	Programme Course Version Local ID, EDUMIS	EDUMIS from linked enrolment Programme Course Local ID from linked programme
55300	The supplied linked programme does not exist	Programme Course Version Local ID, EDUMIS	EDUMIS from linked enrolment, Programme Course Local ID from linked programme
	Learner based		
40020	Iwi must be a Level 2 Iwi code	National Student Number, Learner Local Identifier	
40120	Ethnicities must be unique	National Student Number, Learner Local Identifier	(Each distinct duplicate) Ethnicity Code
40130	Ethnicity must be a Level 3 Ethnicity code	National Student Number, Learner Local Identifier	
40140	NSN does not match a master NSN on the NSI	National Student Number, Learner Local Identifier	
40150	Date of birth does not match date of birth on the NSI	National Student Number, Learner Local Identifier	Learner Birth Date
40160	Learner already exists with a different Local ID, must use the same Local ID	National Student Number, (submitted) Learner Local Identifier	(previous) Learner Local Identifier

Error code	Short description	Object identifiers	Parameters
40170	Unable to process request as learner not found in the ITR database.	National Student Number, Learner Local Identifier	
40180	NZ school provider number must be valid	National Student Number, Learner Local Identifier	(submitted) Provider Number
40190	Overseas country code must be valid	National Student Number, Learner Local Identifier	(submitted) Country Code
40200	Learner Local ID does not match a record in the ITR for this NSN	National Student Number, Learner Local Identifier	
40210	Cannot update a learner that your organisation has not previously submitted events for	National Student Number, Learner Local Identifier	
	Training agreement based	ALL errors include: - National Student Number - Learner Local Identifier - Training Agreement Local Identifier	
1.2.7	Employer head office name cannot be empty		
41020	Employment TLA could not be found		Employment Location TLA Code
41110	Employment type could not be found		Employment Type Code
XSD	Prior activity cannot be empty		
XSD	Prior activity must be a number		
XSD	Prior activity could not be found		
41210	Industry code must be a Level 4 industry code		Industry Code
XSD	Training agreement signed date cannot be empty		
XSD	Training agreement signed date must be a date		
41300	Training Agreement Local identifier cannot be empty		
41310	Training agreement local identifier already exists, must be unique		
41500	The age of the learner at the signed date of the training agreement was below the minimum age allowed, and no MoE exemption code has been supplied		Training Agreement Signed Date Learner Birth Date
41510	Training agreement signed date must be on or before the processing date		Training Agreement Signed Date Processing Date
41520	Training agreement signed date is older than the allowed backdate period		Training Agreement Signed Date
41530	Training agreement signed date must be after the learner's birth date		Training Agreement Signed Date Learner Birth Date

Error code	Short description	Object identifiers	Parameters
41540	Training Agreement not found for this organisation and learner		
41550	Training Agreement has already finished		Training Agreement Status
41560	Training Agreement Signed Date must be the same as the original Training Agreement Signed Date		Training Agreement Signed Date (previous) Training Agreement Signed Date
41570	Training agreement signed date should pre-date enrolment participation start date		Training Agreement Signed Date
41580	Training agreement signed date should pre-date training plan start date		Training Agreement Signed Date
41600	Training agreement signed date should pre-date on-hold or in-grace event occurred date		Training Agreement Signed Date
	Enrolment based	ALL errors include: - National Student Number - Learner Local Identifier	
41700	The linked previous enrolment is in a completed state	Programme Enrolment Local ID (new ITO), Programme Course Version Local ID (new ITO), Learner Local ID (new ITO), Training Agreement Local ID (old ITO), Programme Enrolment Local ID (old ITO), Programme Course Local ID (old ITO), Learner Local ID (old ITO)	Enrolment Status of previous enrolment
41800	The linked previous enrolment is not in a withdrawn state	Programme Enrolment Local ID (new ITO), Programme Course Version Local ID (new ITO), Learner Local ID (new ITO), Training Agreement Local ID (old ITO), Programme Enrolment Local ID (old ITO), Programme Course Local ID (old ITO), Learner Local ID (old ITO)	Enrolment Status of previous enrolment

Error code	Short description	Object identifiers	Parameters
		Learner Local ID (old ITO)	
41900	The linked enrolment is not in a linked programme	Programme Enrolment Local ID (new ITO), Programme Course Version Local ID (new ITO), Learner Local ID (new ITO), Training Agreement Local ID (old ITO), Programme Enrolment Local ID (old ITO), Programme Course Local ID (old ITO), Learner Local ID (old ITO)	Programme Course Local Id (old ITO) Programme Course Local Id (new ITO)
41950	The linked enrolment is not in a linked complex programme	Programme Enrolment Local ID (new ITO), Programme Course Version Local ID (new ITO), Learner Local ID (new ITO), Training Agreement Local ID (old ITO), Programme Enrolment Local ID (old ITO), Programme Course Local ID (old ITO), Learner Local ID (old ITO)	Programme Course Local Id (old ITO) Programme Course Local Id (new ITO)
41960	The supplied ceasing enrolment ID is invalid	Programme Enrolment Local ID (new ITO), Programme Course Version Local ID (new ITO), Learner Local ID (new ITO),	Programme Enrolment Local ID (old ITO)
41980	The participation start date of new enrolment is within two days of the participation start date of the linked previous enrolment.	Programme Enrolment Local ID (new ITO), Programme Course Version Local ID (new ITO), Learner Local ID (new ITO), Training Agreement Local ID (old ITO),	Participation Start Date (old enrolment) Participation Start Date (new enrolment)

Error code	Short description	Object identifiers	Parameters
		Programme Enrolment Local ID (old ITO), Programme Course Local ID (old ITO), Learner Local ID (old ITO)	
42000	The linked enrolment has been linked to by a different enrolment	Programme Enrolment Local ID (new ITO), Programme Course Version Local ID (new ITO), Learner Local ID (new ITO), Training Agreement Local ID (old ITO), Programme Enrolment Local ID (old ITO), Programme Course Local ID (old ITO), Learner Local ID (old ITO)	Programme Course Local Id (old enrolment) Programme Course Version Number (old enrolment)
42100	The linked enrolment is not for the same master NSN	Programme Enrolment Local ID (new ITO), Programme Course Version Local ID (new ITO), Learner Local ID (new ITO), Training Agreement Local ID (old ITO), Programme Enrolment Local ID (old ITO), Programme Course Local ID (old ITO), Learner Local ID (old ITO)	Master NSN (old enrolment learner) Master NSN (new enrolment learner)
42200	A ceasing enrolment ID is not supported for this message	Programme Enrolment Local ID (old ITO)	Programme Enrolment Local ID (Old ITO)
42510	All of the enrolments must be funded from the same fund	-	List of all Funds for the submitted enrolments
42520	A learner cannot have concurrent MA or NZA enrolments. Information on the learner's current enrolment is included in the parameters	Enrolment Local Identifier	Enrolment Participation Start Date Enrolment Participation Actual End Date
42530	Cannot submit more than one enrolment funded by Modern Apprenticeship	-	List of Enrolment Local Identifiers for each Modern Apprenticeship enrolment submitted

Error code	Short description	Object identifiers	Parameters
42540	The enrolment local identifiers must all be unique	-	List of duplicated Enrolment Local Identifiers submitted
42550	The enrolment local identifier is already in use	Enrolment Local Identifier	
42560	Enrolment participation start date must be on or after the enrolment date	Enrolment Local Identifier	Participation Start Date Enrolment Date
42580	Sub-programme enrolment date must be on or after the overarching programme enrolment date	Enrolment Local Identifier	Sub Programme Enrolment Date Overarching Programme Enrolment Date
42600	Enrolment date must be on or after the training agreement signed date	Enrolment Local Identifier	Enrolment Date Training Agreement Signed Date
42630	Enrolment must be in a programme that has been registered previously	Enrolment Local Identifier	Programme Number Programme Version Number
42650	Enrolment must be in a programme which is active as at the enrolment participation start date	Enrolment Local Identifier	Programme Number Programme Version Number Participation Start Date
42660	A simple enrolment must be in a valid programme type (LCP, SCP or NQ)	Enrolment Local Identifier	Programme Number Programme Version Number
42670	Enrolment funding source must be valid for programme	Enrolment Local Identifier	Programme Number Programme Version Number Fund
42680	Learner has already enrolled in this programme	Enrolment Local Identifier	(previous) Enrolment Local Identifier
42690	Cannot submit enrolments in the same programme	List of Enrolment Local Identifiers	Programme Number
42800	Enrolment must be in unit standards for this programme	Enrolment Local Identifier	Programme Number Programme Version Number Unit Standard Number provided Unit Standard Version Number provided
42810	The unit standard number must be unique across all submitted enrolments	List of Enrolment Local Identifiers	Unit Standard Number
42820	Unit standard must be registered and active at NZQA as at the Participation Start Date	Enrolment Local Identifier	Unit Standard Number Unit Standard Version Number Unit Standard Is Currently Active Indicator Unit Standard Last Assessment Date Unit Standard Expiry Date

Error code	Short description	Object identifiers	Parameters
			(Refer to Section 5.5.4 for the logic that uses the latter three parameters.)
42830	Unit standard matches a unit standard already achieved by the learner before the Participation Start Date. If unit standard is not included in RoA the learner should contact NZQA	Enrolment Local Identifier	Unit Standard Number Unit Standard Version Number
42850	Unit standard does not exist for this programme	Enrolment Local Identifier	Unit Standard Number Unit Standard Version Number
42840	Unit standard matches a unit standard already achieved by the learner after the Participation Start Date. If unit standard is not included in their Record of Achievement the learner should contact NZQA	Enrolment Local Identifier	Unit Standard Number Unit Standard Version Number
42860	Unit standard must be unique across all previous enrolments for this learner for across all ITOs	Enrolment Local Identifier	Unit Standard Number
42880	A complex MA or NZA with only one sub-programme must have at least one additional standard	Enrolment Local Identifier (sub-programme)	
42890	Programme type for the overarching programme must be Complex MA or NZA	Enrolment Local Identifier	Programme Number Programme Version Number
42900	Enrolment must be in a sub-programme that has been registered with the overarching programme	Enrolment Local Identifier	Programme Number Programme Version Number Sub Programme Number Sub Programme Version Number
43000	Additional standard must be registered against the Complex MA or NZA	Enrolment Local Identifier	Programme Number Programme Version Number Unit Standard Number provided Unit Standard Version Number provided
43010	Sub-programme enrolment participation start date must be on or after the overarching programme enrolment participation start date	Enrolment Local Identifier	Sub Programme Enrolment Participation Start Date Overarching Programme Enrolment Participation Start Date
43020	Enrolment not found for this organisation and learner	Enrolment Local Identifier	
43030	Enrolment does not have a status that is valid to be updated	Enrolment Local Identifier	Enrolment Status
43040	Programme must be the same as the Programme on the original enrolment	Enrolment Local Identifier	Programme Number provided Programme Version Number provided
43050	Funding Source Code must be the same as the Funding Source Code on the original enrolment	Enrolment Local Identifier	Fund Fund provided
43070	Units achieved after the participation start date must be included in this enrolment	Enrolment Local Identifier	List of Unit Standard Numbers achieved but not included in this enrolment
43080	Training Agreement not found for this organisation and learner	Enrolment Local Identifier	Training Agreement Local Identifier

Error code	Short description	Object identifiers	Parameters
43090	Training Agreement not at a status valid to add an enrolment	Enrolment Local Identifier	Training Agreement Status
43100	Enrolment funding source must not be MA or NZA	Enrolment Local Identifier	Fund
43120	Sub-programmes on original enrolment must be included in this enrolment	Enrolment Local Identifier	List of Enrolment Local Identifiers originally enrolled in but not included in this enrolment
43130	Participation Start Date must be the same as the Participation Start Date on the original enrolment.	Enrolment Local Identifier	Participation Start Date provided
43140	Enrolment Local ID must be for the overarching programme enrolment	Enrolment Local Identifier	
43150	Enrolment Local ID cannot be for a Sub-Enrolment	Enrolment Local Identifier	
43170	Enrolments in a LCP and SCP must have at least one unit standard	Enrolment Local Identifier	
43160	Cannot have enrolments with different funding types in the same training agreement.	Enrolment Local Identifier	Fund
43180	Unit standards achieved after the latest transfer date must be included in this enrolment.	Enrolment Local Identifier	Unit Standard Number
43190	Unit standard must be registered and active at NZQA as at the latest transfer date.	Enrolment Local Identifier	Unit Standard Number Unit Standard Version Number Unit Standard Is Currently Active Indicator Unit Standard Last Assessment Date Unit Standard Expiry Date
43200	Unit standard must be registered and active at NZQA as at the transfer date.	Enrolment Local Identifier	Unit Standard Number Unit Standard Version Number Unit Standard Is Currently Active Indicator Unit Standard Last Assessment Date Unit Standard Expiry Date
43210	Cannot change enrolment date.	Enrolment Local Identifier	Enrolment Date
43220	Enrolment transfer date must be after participation start date.	Enrolment Local Identifier	Enrolment Participation Start Date Enrolment Transfer Date
43230	Enrolment transfer date must be after latest transfer date.	Enrolment Local Identifier	Enrolment Latest Transfer Date Enrolment Transfer Date
43240	Units achieved after transfer date must be included in this enrolment.	Enrolment Local Identifier	Unit Standard Number
43250	Unit standard matches a unit standard already achieved by the learner before the Transfer Date. If unit standard is not included in RoA the learner should contact NZQA.	Enrolment Local Identifier	Unit Standard Number Unit Standard Version Number Enrolment Participation Start Date OR Enrolment Latest Transfer Date OR Enrolment Transfer Date

Error code	Short description	Object identifiers	Parameters
43255	Unit standard matches a unit standard already achieved by the learner after the Transfer Date. If unit standard is not included in their Record of Achievement the learner should contact NZQA	Enrolment Local Identifier	Unit Standard Number Unit Standard Version Number
43260	Enrolment does not have a status that is valid to be transferred.	Enrolment Local Identifier	Enrolment Status
43280	Enrolment must be in a programme which is active as at the enrolment transfer date.	Enrolment Local Identifier	Programme Course Number Programme Course Version Number Enrolment Participation Start Date OR Enrolment Latest Transfer Date OR Enrolment Transfer Date
43290	Sub-programmes that are not complete as at transfer date must be included in the message.	Enrolment Local Identifier	EnrolmentLocalIdentifier
43300	Sub-programmes that are complete before the transfer date cannot be included in the message.	Enrolment Local Identifier	EnrolmentLocalIdentifier
43310	Unit standard matches a unit standard already achieved by the learner before the Latest Transfer Date. If unit standard is not included in RoA the learner should contact NZQA.	Enrolment Local Identifier	Unit Standard Number Unit Standard Version Number Enrolment Participation Start Date OR Enrolment Latest Transfer Date OR Enrolment Transfer Date
43315	Unit standard matches a unit standard already achieved by the learner after the latest Transfer Date. If unit standard is not included in their Record of Achievement the learner should contact NZQA		Unit Standard Number Unit Standard Version Number
43420	Enrolment cannot be completed against non-active programme version funding code	Enrolment Local Identifier	Programme Course Number Programme Course Version Funding Source Code
43430	Enrolment participation start date for New Zealand Apprenticeship must be after cut-off date	Enrolment Local Identifier	Programme Course Number Programme Course Version Enrolment Participation Start Date
43400	Cannot submit Modern Apprenticeship enrolments after 1st Jan 2014	Enrolment Local Identifier	Enrolment Participation Start Date
43410	Backdated Modern Apprenticeship enrolments received after 31st Mar 2014 are not accepted	Enrolment Local Identifier	ESIS Received Date
43440	Cannot submit more than one enrolment funded by New Zealand Apprenticeship.	Enrolment Local Identifier	Enrolment Participation Start Date
	Delete programme enrolment based		
43470	Enrolment is already deleted	Enrolment Local Identifier	Enrolment Status

Error code	Short description	Object identifiers	Parameters
43460	ESIS received date must be within the same year as the enrolment participation date or within first quarter(i.e. 31st of March) of next year	Enrolment Local Identifier	ESIS Received Date
43490	Enrolment cannot be deleted because it cannot be readded back into ITR because it would fail validation	Enrolment Local Identifier	
43500	Invalid Enrolment Tracking Indicator type code	NSN Learner Local ID Enrolment Local ID	Enrolment Tracking Indicator
Update programme based			
60010	Programme cannot be found	Organisation Programme Identifier, Programme Number	n/a
60020	The Terms and Conditions must be accepted	Organisation Programme Identifier, Programme Number	Nil
60030	Existing programme has expired.	Organisation Programme Identifier, Programme Number	Processing Date Existing Expiry Date
60040	Expiry date must be greater than the start date of the existing programme	Organisation Programme Identifier, Programme Number	Expiry Date Start Date (of existing programme version)
60050	Update funding codes must be same as existing funding codes	Organisation Programme Identifier, Programme Number	FundingSourceCode(s)
Withdraw Enrolment based			
		ALL errors include: - National Student Number - Learner Local Identifier - Enrolment Local Identifier	
70010	Enrolment not found for organisation and learner	-	
70020	Programme does not exist for this enrolment	-	Programme Number Programme Version Number
70030	Enrolment status must be Active, Pending, Hold, Grace or Withdrawn	-	Enrolment Status
70050	Withdrawal Date must be less than or equal to the processing date	-	Enrolment Withdrawal Date Processing Date

Error code	Short description	Object identifiers	Parameters
70060	Enrolment Local ID must be for the overarching programme enrolment		
70070	Withdrawal date must be greater than enrolment participation start date	-	Enrolment Withdrawal Date Enrolment Participation Start Date
70080	Enrolment withdrawal date must be earlier than current enrolment withdrawal date.	-	Enrolment Withdrawal Date
	Withdraw Training Agreement based	ALL errors include: - Training Agreement Local Identifier	
80010	Training Agreement not found for this organisation and learner		
80020	Training Agreement not at a status valid to be withdrawn		Training Agreement Status
80030	Withdrawal Date must be greater than or equal to the Training Agreement Signed Date		Training Agreement Withdrawal Date Training Agreement Signed Date
80040	Withdrawal Date must be less than or equal to the processing date		Training Agreement Withdrawal Date Processing Date
80050	Withdrawal date must be after the latest enrolment participation start date		Training Agreement Withdrawal Date Enrolment Participation Start Date
	Create/Update Training Plan	ALL errors include: - National Student Number - Learner Local Identifier - Training Plan Local Identifier	
90010	Training Agreement cannot be found for this organisation and learner		Training Agreement Local Identifier
90020	Training Agreement does not have a status that is valid to have a Training Plan created		Training Agreement Status
90030	Training Agreement already has a Training Plan		Existing Training Plan Local Identifier
90040	Training Plan local identifier must be unique		
90050	Enrolments must be funded by Modern Apprenticeship, for a Training Plan to be added		
90060	MAC Provider number is not for an active organisation authorised with the MAC role		MAC Provider Number
90070	Training Plan signed date must be on or before the processing date		Training Plan Signed Date Processing date

Error code	Short description	Object identifiers	Parameters
90080	Training Plan signed date must be greater than or equal to Training Agreement signed date		Training Plan Signed Date Training Agreement Signed Date
90090	Programme is not active as at the Training Plan signed date		Enrolment Local Identifier Training Plan Signed Date
90100	Training Plan cannot be found for this organisation and learner		
90110	Training Agreement does not have a status that is valid to have the Training Plan signed date updated		Training Agreement Status
90120	Training Agreement was already associated with a different Training Plan at the signed date		Existing Training Plan Local Identifier Training Plan Signed Date
90130	MAC visit exists before the new Training Plan signed date		Training Plan Signed Date
90140	Training Plan is not current		
	Transfer MAC (note that some of the Create/Update Training Plan error codes will be reused)	ALL errors include: - National Student Number - Learner Local Identifier - New Training Plan Local Identifier	Note the operation parameters in this section are from the new Training Plan (not the existing Training Plan).
90100	Training Plan cannot be found for this organisation and learner		
100010	Training Agreement does not have a status that is valid for the MAC to be transferred		Training Agreement Status
90040	Training Plan local identifier must be unique		
100020	MAC Provider number is the same as on the existing Training Plan		MAC Provider Number
90060	MAC Provider number is not for an active organisation authorised with the MAC role		MAC Provider Number
90070	Training Plan signed date must be on or before the processing date		Training Plan Signed Date Processing date
100030	Training Plan signed date must be greater than the previous Training Plan signed date		Training Plan Signed Date
	Record/Delete MAC Visit	ALL errors include: - National Student Number - Learner Local Identifier Training Plan Local Identifier	

Error code	Short description	Object identifiers	Parameters
110010	Training Plan cannot be found for this organisation and learner		
110030	Visit Date must be greater than or equal to the Training Plan Signed Date		Visit Date Training Plan Signed Date
110040	Visit Date must be less than or equal to the processing date		Visit Date Processing Date
110050	A visit has already been recorded for this date. Visit Dates must be unique		Visit Date
110060	Training Plan is not current		
110070	Visit Date does not match a Visit Date associated with the Training Plan		Visit Date
	Pause Training Agreement (Hold. Grace)	ALL errors include: - National Student Number - Learner Local Identifier Training Agreement Local Identifier	
130010	Training Agreement cannot be found for this organisation and learner		
130020	Training Agreement does not have a status that is valid to be placed on hold		Training Agreement Status
130030	Training Agreement does not have a status that is valid to start grace period		Training Agreement Status
130040	Pause Date must be greater than the Training Agreement Signed Date		Pause Date Training Agreement Signed Date
130050	Pause Date must be less than or equal to the processing date		Pause Date Processing Date
	Restart Training Agreement	ALL errors include: - National Student Number - Learner Local Identifier Training Agreement Local Identifier	
140010	Training Agreement cannot be found for this organisation and learner		
140020	Training Agreement does not have a status that is valid to restart		Training Agreement Status
140030	Restart Date must be greater than equal to the hold Start Date		Restart Date

Error code	Short description	Object identifiers	Parameters
			Hold Start Date
	Transfer Employer	ALL errors include: - National Student Number - Learner Local Identifier - new Training Agreement Local Identifier	
150010	Training Agreement not found for this organisation and learner		Old Training Agreement Local Identifier
150020	Training Agreement has already finished		Training Agreement Status
150030	Training Agreement Local Identifier already exists, must be unique		
150040	Employment TLA could not be found		Employment Location TLA Code
150050	Industry Code must be a Level 4 industry code		Industry Code
150060	Employment Type could not be found		Employment Type Code
150070	Employer Head Office Name, Employer Sub Division Name or Employment Location TLA Code new training agreement must be different from the old training agreement.		
150080	Training Agreement Signed Date must be on or before the processing date		Training Agreement Signed Date Processing Date
150090	New Training Agreement Signed Date must be greater than the old Training Agreement Signed Date		Training Agreement Signed Date (previous) Training Agreement Signed Date
150100	The age of the learner at the signed date of the training agreement was below the minimum age allowed, and no MoE exemption code has been supplied		Training Agreement Signed Date Learner Birth Date
150110	The signed date of the new training agreement is the same date or before the signed date of the previous training agreement in a grace period.		Training Agreement Signed Date (new training agreement) Training Agreement Local Identifier (old training agreement)
	Get Training Agreement Details	ALL errors include: - Learner Local Identifier - Training Agreement Local Identifier	
160010	Learner Local Identifier not found for this organisation		
160020	Training Agreement not found for this organisation and learner		

Error code	Short description	Object identifiers	Parameters
160030	Enrolment not found for this organisation and learner		